

ECO Vac

# Owner Instructions

Original Instructions

Warning! Read instructions before using the machine



PPT 220-B2  
PPT 390-B2



[www.numatic.com](http://www.numatic.com)



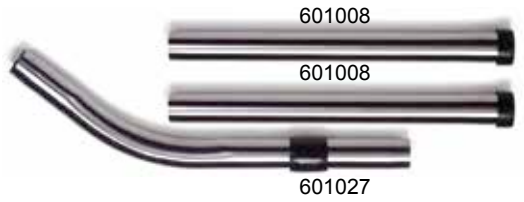

## Assembly

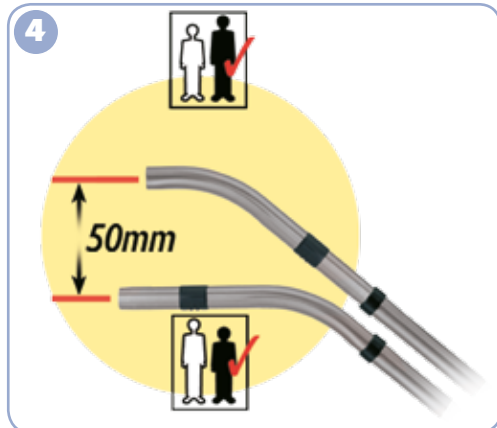

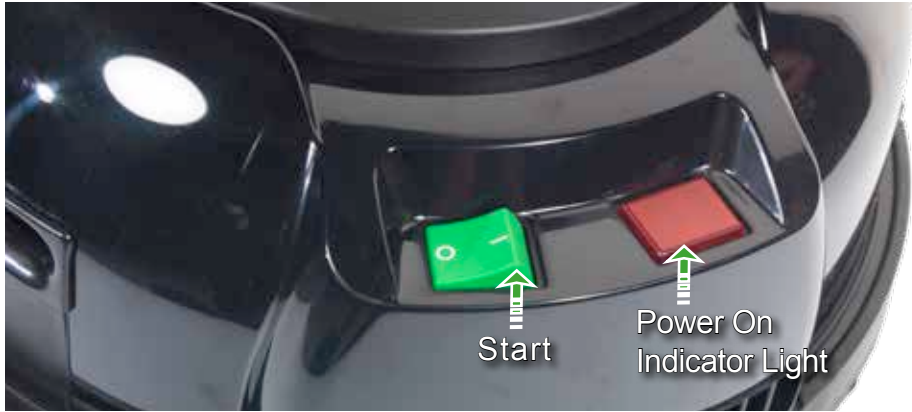

## Using the Machine



607233  
Red Caddy



607222  
Blue Caddy

## NPT / PPT Extra Caddy Kit

## Using the Machine

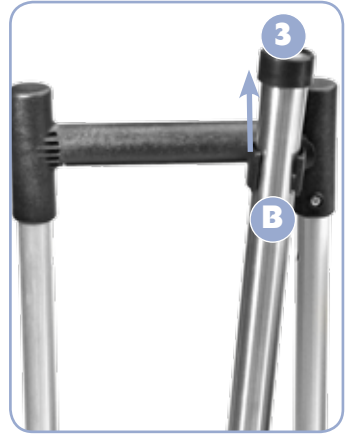
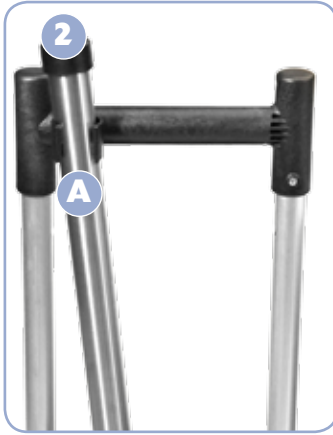

## Cleaning the machine



# PPR Plugged Cable

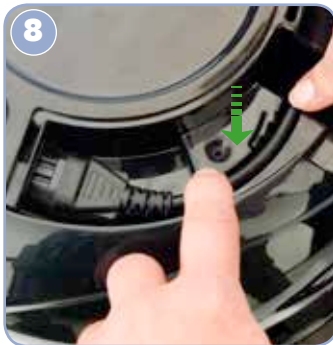

## Rating Label

- 1 Voltage
- 2 Frequency
- 3 Rated Input Power
- 4 Weight (ready to work)
- 5 Company Name & Address
- 6 Model
- 7 Machine yr/wk Serial number
- 8 WEEE Logo
- 9 Protection Class 2 Symbol
- 10 CE Mark



**PPE** (personal protective equipment) That may be required for certain operations.



Ear Protection



Safety Footwear



Head Protection



Safety Gloves



Eye Protection



Protective Clothing



Dust / Allergens Protection



Hi Vis Jacket



Caution Floor Sign

**NOTE:** A risk assessment should be conducted to determine which PPE should be worn.

## Safety Critical Components

**Mains leads:**

HO5-V2V2-F 12.5 x 2 x 1.00 mm<sup>2</sup>

## WEEE Legislation

**(Waste, Electrical and Electronic Equipment)**

Vacuum cleaner, accessories and packaging should be sorted for environmentally - friendly recycling.

*(Only for EU Countries)*

Do not dispose of vacuum cleaner into household waste! According to the European Directive 2002 / 96 / EC on waste electrical and electronic equipment and its incorporation into national law.

Vacuum cleaners that are no longer suitable for use must be separately collected and sent for recovery in an environmentally - friendly manner.

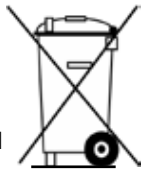

Failure to rectify the problem or in the event of a breakdown contact your Numatic dealer or the Numatic Technical helpline +44 (0)1460 269268

## Data

	Rated input power	Drum Size	Cleaning Range	Weight (Ready to work)	Sound Power	Sound Pressure
220	780 W	9 L	31.8 m	12.7 kg	76 dB (A)	64.8 dB (A)
390		15 L		13.0 kg		Uncertainty 0.2 dB
Protection Class				Size		
220	Class II			355 x 355 x 615 mm		
390				355 x 355 x 665 mm		



# Information for DRY USE Vacuum cleaners



## WARNING

### Ensure you read the instruction manual before using the machine.

Operators shall be adequately instructed on the use of these machines, as with all electrical equipment, care and attention must be exercised at all times during use, you must also make certain that routine and preventative maintenance is carried out periodically to ensure safe operation.

Failure to carry out maintenance as necessary, including the replacement of parts to the correct standard could render this equipment unsafe and the manufacturer can accept no responsibility in this respect.

This machine is for DRY USE only

You must disconnect the machine from the mains by removing the plug from the supply socket BEFORE cleaning or maintenance and when replacing parts or converting the machine to another function.

This appliance is intended to be assembled, cleaned and maintained by an adult.

This machine is not suitable for the collection of biological hazards, hazardous or explosive dusts. Contact your local distributor if you require a machine capable of performing these tasks.

This machine is not a toy; children shall not play with this machine.

The machine must not be used by persons with reduced physical, sensory or mental capabilities, or lack of experience or knowledge, unless they have been given supervision or instruction.

You must not allow the supply cord to come into contact with rotating brushes (if fitted).

Only use the socket outlet on the machine for purposes specified in the instructions (where fitted).



## CAUTION

This machine must not be stored outside, or used in wet environments, or to collect wet materials.

The vacuum cleaner should be stored in a dry place and is for indoor use only.

You must ensure that the filtration system fitted to the machine is suitable for the material being collected.

## NOTES

This product complies with the requirements of EN 60335-2.69 2012.

The primary use for this machine is commercial, for example in hotels, schools, hospitals, factories, shops and offices.

If the vacuum cleaner stops working, remove the plug from the wall before investigating where the fault lies.

If the vacuum cleaner has a blockage, switch off, remove the plug from the socket outlet, and inspect the floor tool, wands and hose for debris. If the floor tool, wands and hose are clear, replace the dust bag and clean the filter.

The vacuum cleaner should be inspected after use for damage.

The power light will illuminate, when your machine is connected to a suitable power supply.



## DO

- Keep your machine clean.
- Keep filters clean.
- Use filter bags, they will enhance performance and help keep machine clean.
- Use a Numatic original filter bag under fine dust conditions.
- Keep hoses and tubes clear.
- Replace any worn or damaged parts immediately.
- Regularly examine the power cord. If damage is found such as cracking or ageing the power cord must be replaced by a competent person using the correct Numatic original part.

- Change dust bag frequently.
- Keep diffuser filter (where fitted) clean.
- Only use the brushes provided with the machine. The use of other brushes may impair safety.



## DON'T

- Unreel the cable with one pull or pull on the cable to unplug the machine from the power supply.
- Use to suck up hot ashes or lighted cigarette ends.
- Use steam cleaners, pressure washers or immerse in water to clean the machine.
- Attempt machine maintenance or cleaning unless the power supply plug has been removed from the supply outlet.
- Use in a wet environment or to collect wet materials.
- Store your machine in wet conditions.



## EU DECLARATION OF CONFORMITY

We hereby declare under our sole responsibility that the following equipment fulfils all the relevant provisions of the following EU Directives:

Machinery Directive 2006/42/EC  
 EMC Directive 2004/108/EC  
 RoHS Directive 2011/65/EU  
 Energy labelling of vacuum cleaners EU/665/2013 - 2010/30/EU  
 Eco design requirements for vacuum cleaners EU/666/2013 - 2009/125/EC

**Machine Description:** Vacuum Cleaner  
**Type:** PPR, PPT, PPH, NPR, NPT, HXL, PVT series

**Manufactured by:** Numatic International Limited

Relevant standards upon which conformity is declared include:

IEC 60335-1  
 EN 60335-1:2012  
 IEC 60335-2.2  
 IEC 60335-2.69  
 EN 60335-2.69:2012  
 EN 55014-1:2006  
 EN 55014-2:1997 +A1:2001 (Cat II)  
 EN 61000-3-2:2006  
 EN 61000-3-3:1995 +A1+A2  
 EN 62233:2008

A technical construction file for this equipment is retained at the manufacturer's address under the authorisation of the following signatory:

**Name:** Allyn Boyes **Position:** Technical Manager

Signed:



Date: 01 /06/2014

Numatic International Limited,  
 Chard, Somerset.  
 TA20 2GB  
[www.numatic.co.uk](http://www.numatic.co.uk)

# GB

## Schematic Diagram

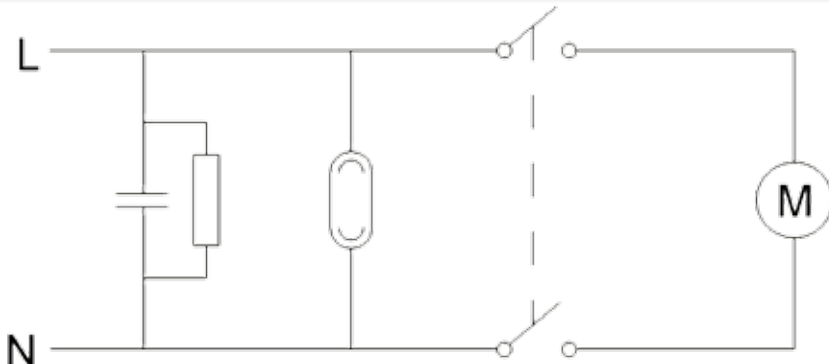

# Numatic International Warranty

Numatic International Limited warrant to the original purchaser that its products are free of defects in both material or workmanship for the period shown below:-

Homecare and Cleancare Vacuum cleaners.....	2 Years
Rotary Floor Machines.....	2 Years
Twintec Auto Scrubber Dryer.....	1 Year
Vario Ride-On Scrubber Dryer.....	1 Year / 1500 hours
Mopping, Compacts, Combi and Servocare Products.....	1 Year
Individual Accessories and Spare Parts.....	6 Months

Note: This warranty expressly excludes consumable parts such as carbon brushes, floor brushes, mops, batteries etc, that are considered replaceable from time to time during the normal working life of the machine.

- A. The warranty period commences from the date the goods are purchased.
- B. All warranty claims must be processed through the Dealer from whom the equipment was purchased. The Dealer will co-operate with the purchaser throughout the warranty claims procedure and will arrange any necessary repairs using genuine Numatic parts.
- C. If the original Dealer is no longer able to fulfil his obligations please contact Numatic International Limited with full details of the claim and proof of purchase so that this may be processed without delay.
- D. Any warranty claim can only relate to the specific part that is proven to be at fault and for which a replacement will be supplied but cannot be extended to constitute a claim against the complete machine.
- E. Numatic International will supply the Dealer with any warranty parts required, subject to the claim being validated, after return of the faulty items in accordance with Numatic International Limited's General Conditions of Sale.
- F. Claims will not be accepted if they are the result of fair wear and tear, misuse or abuse of any kind.
- G. No replacement will be given unless the appropriate evidence of the validity of the claim has been provided to the satisfaction of Numatic International Limited.
- H. Numatic International Limited reserve the right to charge for any unnecessary work carried out as a result of an invalid claim.
- I. No variation to this warranty may be made or implied by any member of Numatic International Limited or its Dealers unless such variation is in writing and authorised by the Company



Numatic International Limited. Chard, Somerset, TA20 2GB

Telephone: 01460 68600 Fax: 01460 68458

© Numatic International Limited

## Replacement parts

### TriTex / Microfresh Filter

604165

TriTex Filter

### HepaFlo Dust Bags

604015

NVM 1CH (Pack of 10) (220 Drum)

604016

NVM 2BH (Pack of 10) (390 Drum)



**ENERG** Y UA  
 енергия · ενεργεια IE IA



PPT



ENERGIA · ЕНЕРГИЯ · ΕΝΕΡΓΕΙΑ  
 ENERGIJA · ENERGY · ENERGIE · ENERGI

**32.7**  
kWh/annum

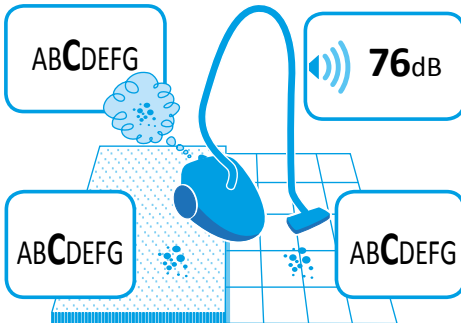

665/2013 - I



Distributed by:-

Numatic International Limited, Chard, Somerset, TA20 2GB  
 Telephone: 01460 68600  
 Fax: 01460 68458

UNITED KINGDOM: [www.numatic.co.uk](http://www.numatic.co.uk)  
 FRANCE: [www.numatic.fr](http://www.numatic.fr)

GERMANY: [www.numatic.de](http://www.numatic.de)  
 NETHERLANDS: [www.numatic.nl](http://www.numatic.nl)

SWITZERLAND: [www.numatic.ch](http://www.numatic.ch)  
 SOUTH AFRICA: [www.numatic.co.za](http://www.numatic.co.za)

Specification subject to change without prior notice

[www.numatic.com](http://www.numatic.com) © Numatic International Limited

244413 07/14 (A02)