

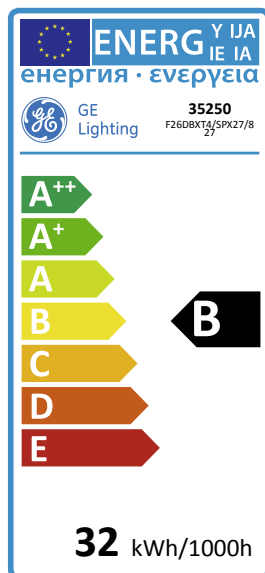

GE
Lighting



32
kWh/1000h

B
energy class

69
lumens/watt

Biax™ D 2-pin, Internal Starter

F26DBXT4/SPX27/827

35250

Product information

Biax™ D & D/E LongLast™ lamps are available in 10, 13, 18 and 26 watt ratings, 10 and 13W in T3 tube size, 18 and 26W in T4 tube size and ranging from 101mm to 174mm in length. Five colours are available in two-pin and four-pin caps. A high colour rendering index (CRI) of 82 gives rich, vibrant colour.

The lamps are available in warm and cool colour temperatures suitable for a wide variety of environments.

Application areas



Office



Industrial



Product data

Cap/Base	G24d-3
Bulb Shape	Quad plug-in
Bulb maximum overall diameter [mm]	34.4
Maximum Overall Length [mm]	169.5
Net weight per piece [g]	74
Gross weight per piece [g]	92
Operating position	U - Universal
Mercury Content [mg]	3
UV radiance	exempt
Brand	General Electric (GE)

Performance data

Colour Code	827
Colour Rendering Index (CRI) [Ra]	82
Nominal correlated colour temperature (CCT) [K]	2700
Nominal lumens [lm]	1800
Energy efficiency class (EEC)	B
Rated Life [h]	10000
Weighted energy consumption [kWh/1000h]	31.35

Electrical data

Nominal power [W]	26
Nominal lamp voltage [V]	105
Operating Temperature (MIN) [°C]	-15
Starting ambient temperature range	-15
Dimming Capability	No

Logistic data

DUN Code	30043168352506
EAN Code	0043168352505
Pack Quantity	10
Layer quantity	600 EUR, 750 UK
Layer quantity EUR	600
Layer quantity UK	750
Pallet quantity EUR (PC)	3000
Pallet quantity UK (PC)	3750
Outer case size	191 x 82 x 187 (mm)
Product status	Available

Technical drawing

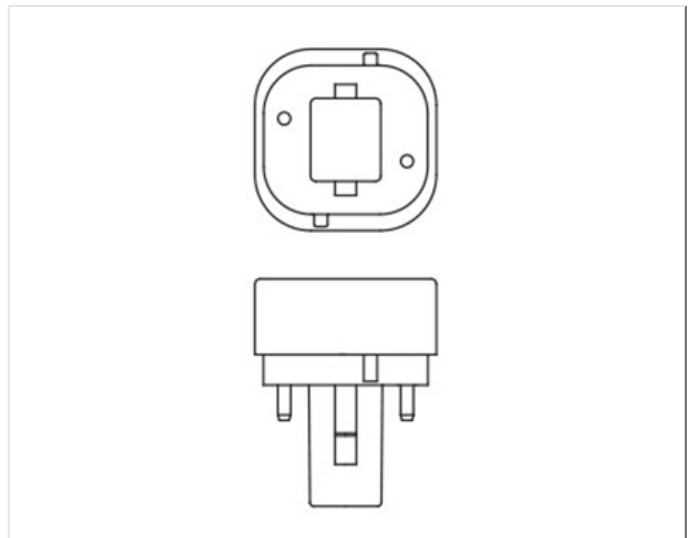
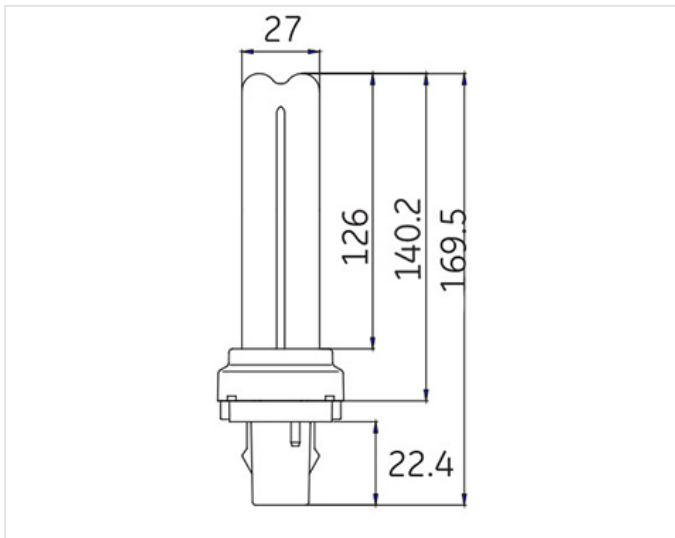

Survival data

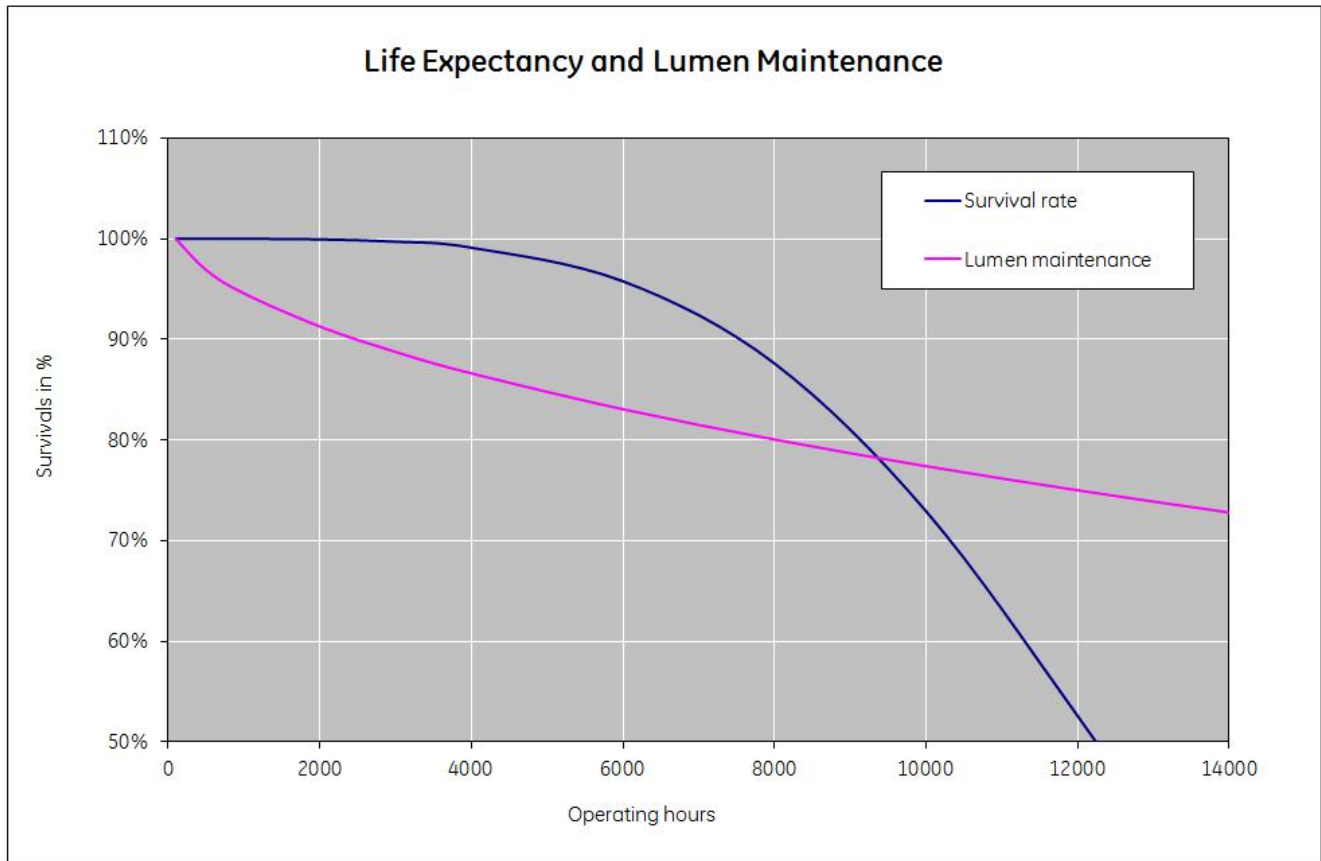

Downloads & Links

[Go to the catalog site \(HTTP\)](#)

[CFL Non-Integrated Spectrum Catalogue \(PDF\)](#)

[LongLast™ Biax™ D and D/E Data sheet \(PDF\)](#)

[Lighting design tools & calculators \(HTTP\)](#)

[Disposing and Cleaning of CFL Lamps \(HTTP\)](#)

[Certificate for the Quality Management System of GE Lighting EMEA \(PDF\)](#)

[Certificate for the Environmental Management System of GE Lighting EMEA \(PDF\)](#)