

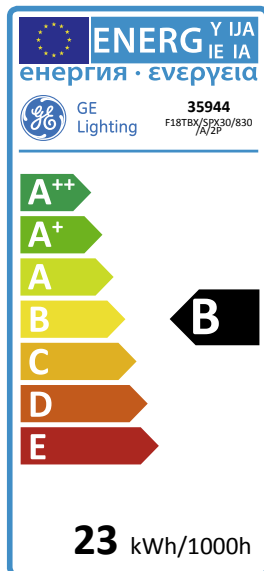

GE  
Lighting



23  
kWh/1000h

B  
energy class

67  
lumens/watt

## Biax™ T 2-pin with Amalgam, Internal Starter

F18TBX/SPX30/830/A/2P

# 35944

### Product information

Ultra compact energy saving CFL lamps with triple-tube design give an ideal light source for small fixtures and downlighters. Biax™ T lamps allow more compact fixture designs with the same lumen output as Biax™ D lamps. They can also be used to deliver higher lumen output from existing designs. The Biax™ T & T/E lamps are electrically interchangeable with Biax™ D and D/E lamps. They are available in 13, 18, 26, 32 and 42W. Light output ranges between 900 and 3200 lumens. Biax™ T/E lamps with a 4-pin electrical connection and without an internal starter are designed for high-frequency electronic ballasts. The use of separate electronic ballasts makes them suitable for almost every kind of energy supply: high and low voltages, accumulators, batteries, solar cells and systems that can be dimmed.

### Application areas



## Product data

Cap/Base	GX24d-2
Bulb Shape	Hex plug-in
Bulb maximum overall diameter [mm]	49.3
Maximum Overall Length [mm]	127.4
Net weight per piece [g]	85
Gross weight per piece [g]	125
Operating position	U - Universal
Mercury Content [mg]	1.3
UV radiance	exempt
Brand	General Electric (GE)

## Performance data

Colour Code	830
Colour Rendering Index (CRI) [Ra]	82
Nominal correlated colour temperature (CCT) [K]	3000
Nominal lumens [lm]	1200
Energy efficiency class (EEC)	B
Rated Life [h]	10000
Weighted energy consumption [kWh/1000h]	22.1

## Electrical data

Nominal power [W]	18
Nominal lamp voltage [V]	100
Operating Temperature (MIN) [°C]	-15
Starting ambient temperature range	-15
Dimming Capability	No

## Logistic data

DUN Code	00043168359443
EAN Code	0043168359443
Pack Quantity	10
Layer quantity	320 EUR, 360 UK
Layer quantity EUR	320
Layer quantity UK	360
Pallet quantity EUR (PC)	1920
Pallet quantity UK (PC)	2160
Outer case size	263 x 110 x 154 (mm)
Product status	Available

## Technical drawing

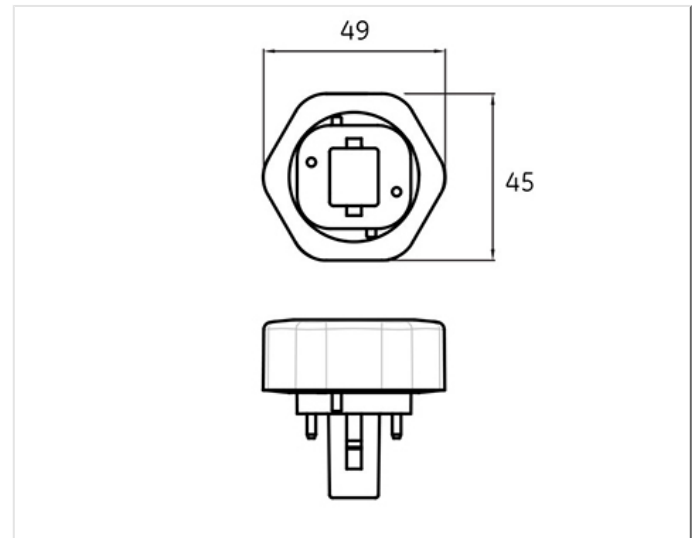
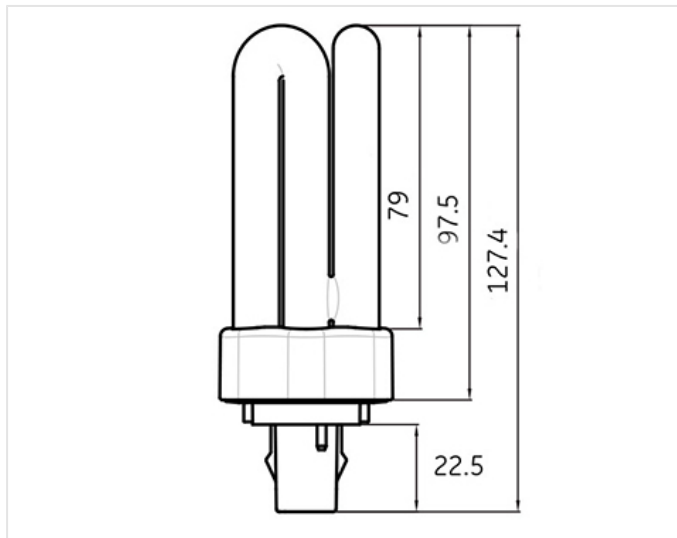

## Survival data

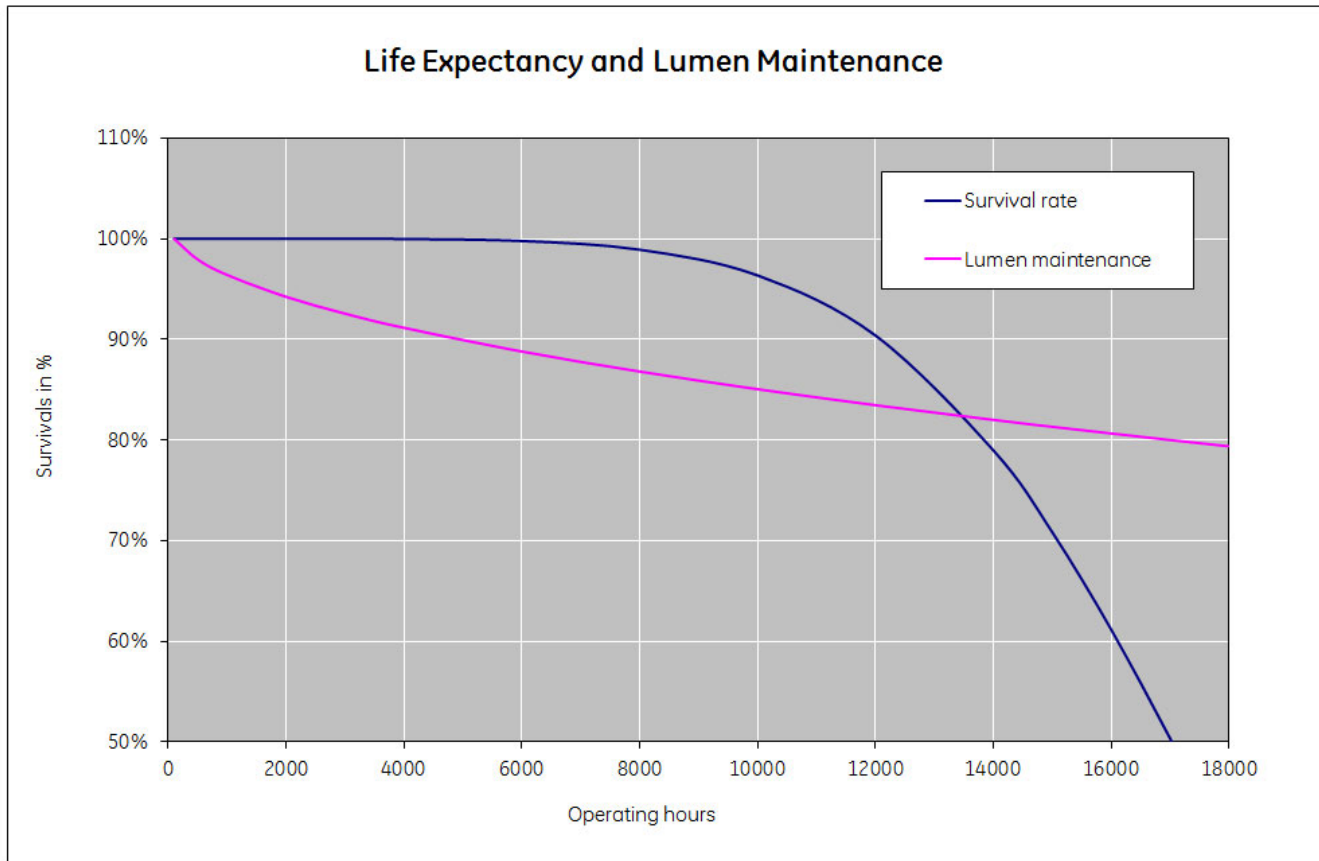

## Downloads & Links

[Go to the catalog site \(HTTP\)](#)

[CFL Non-Integrated Spectrum Catalogue \(PDF\)](#)

[Biax™ T and T/E Data sheet \(PDF\)](#)

[Lighting design tools & calculators \(HTTP\)](#)

[Disposing and Cleaning of CFL Lamps \(HTTP\)](#)

[High-res images / Technical drawings \(HTTP\)](#)

[Certificate for the Quality Management System of GE Lighting EMEA \(PDF\)](#)

[Certificate for the Environmental Management System of GE Lighting EMEA \(PDF\)](#)