

Swordfish

Armoured1000

Professional A2 Laminator

For Professional Use



Scan here to
download or view
these instructions
in other languages



Scan here to
watch a helpful
hints video



Please read this manual completely before using your laminator as incorrect use can cause serious damage.

Safety Precautions

Failure to comply with any of the following safety precautions could result in serious injury, fire or electric shock.



This equipment is not intended for use by children. It is not a toy.



Unauthorised attempts at repair will invalidate the warranty.



Do not allow water, or damp media, to enter the laminator.



Do not cover the laminator, or place anything on it. Risk of fire!



Disconnect after use or when cleaning the laminator.



The laminator is hot and contains hazardous moving parts.



Do not operate the laminator on, or near, combustible objects.



Do not allow clothing or jewellery to enter the laminator. Risk of fire or electric shock!



Do not leave the laminator unattended during operation.



Do not use aerosol products on or near this machine (or any other electrical appliance) as the contents may be flammable.

SPECIFICATIONS

Suitability	
	Small Office & Office
What makes it special?	SuperFast speed, heavy duty
Swordfish UK Product Code	40350
Maximum Paper Size	A2
Colour	Black/Dark Silver
Feed Entry Width (mm)	450mm
Maximum Pouch Thickness	2 x 250 [500] Microns
Maximum Pouch Thickness Total (mm)	1.2mm
Jam Release	✓
Reverse Control	✓
Cold Lamination Option	✓
Auto Shut-Off	✓ after 30 minutes of inactivity
Number of Rollers	4
Warm-up Time	4 - 6 minutes
Speed (time to laminate an A4 sheet)*	22 seconds
Working Speed	500-1000mm/minute
Working Temperature	60 - 160°C
Product Dimensions H x W x D (mm)	110 x 670 x 300
Weight (kg)	22kg
Power	220/230V 50Hz, 850W, 3.9A
Product Warranty (years)	2 years

* Based on using a 2 x 75 [150] micron pouch at speed 6.

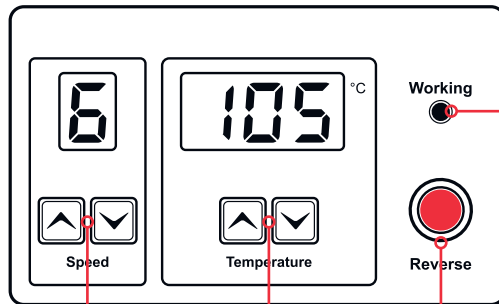
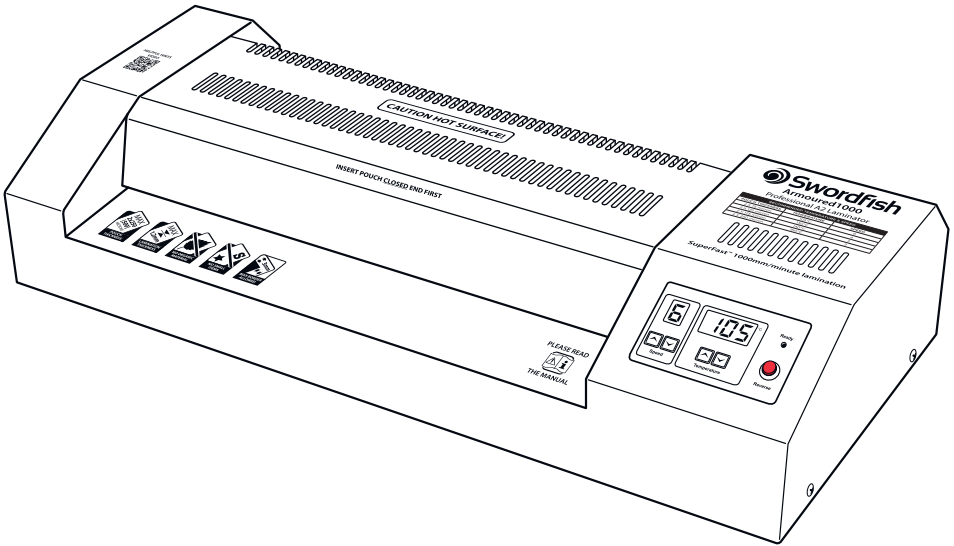

The READY light illuminates when the set temperature is reached

Increase/Decrease Speed

Increase/Decrease Temperature

Reverse Button

Please read this manual completely before using your laminator as incorrect use can cause serious damage. Failure to follow the instructions in this manual could invalidate your warranty!

Quick Start Guide

- 1** Position the laminator on a suitable flat surface, within easy reach of a 13Amp socket, ensuring that there is sufficient space behind the machine for the laminations to lay flat.
- 2** Connect the laminator to the 13Amp socket and press the isolating switch on the back of the machine to the "on" position. The motor and cooling fans will run and the machine will begin to warm up.
- 3** Set the desired temperature according to the guide printed on the laminator. (The default setting is 100°C, speed 3). Note that setting the temperature too high can cause your pouch to jam!
- 4** The green "ready" light will illuminate after 4-6 minutes, depending on the required temperature. Laminating can now begin.
- 5**  You must use a pouch carrier if you intend to laminate any of the following:
 - Multiple items within a single pouch
 - Irregular shaped items
 - Soft material such as newspaper, tissue, paper and fabrics
 - Any item that leaves a border of more than a 3mm around its edges

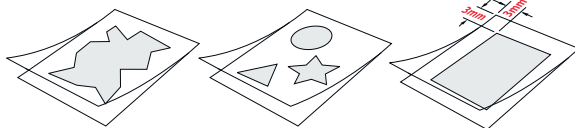

Pouch carriers are available from your usual pouch supplier.

- 6** If the lamination is imperfect, adjust the temperature to correct the fault – see page 9.
- 7** Before turning off, allow the machine to run for 5 minutes with the heaters switched off – see page 9.

To get the best results from your laminator and extend its working life, please turn to page 6.

Getting Started

The Swordfish Armoured1000 A2 laminator is a rugged steel-cased professional laminator that offers both variable speed and variable temperature. It is equipped with sophisticated digital temperature control, massive 44mm precision rollers and a steel cooling plate – all of which combine to give perfect laminations.

1 Position the laminator on a level surface, close to a 13Amp socket.



CAUTION

Do not locate the laminator:

- Near any heat appliances such as heater or stove
- Directly exposed to sunlight
- Close to an air-conditioning unit
- In a poor ventilated environment
- On an irregular or inclined surface

2 Allow enough space behind the laminator for your laminations to lay flat whilst cooling. Do not cover the machine or place anything on top of it.

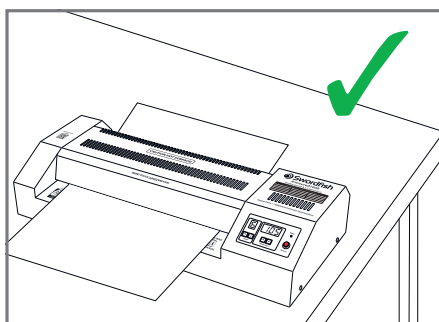
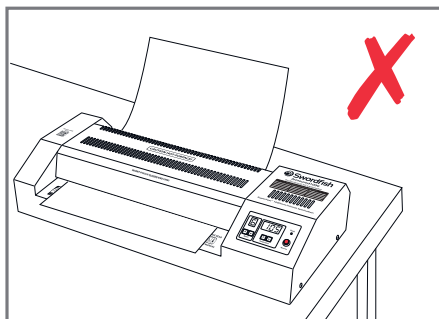

Operation

1 Connect the laminator to the 13Amp socket and turn the isolating switch on the rear of the machine to the "on" position. The motor and cooling fans will run and the machine will begin to warm up.

CAUTION
 Do not leave the laminator unattended during lamination.

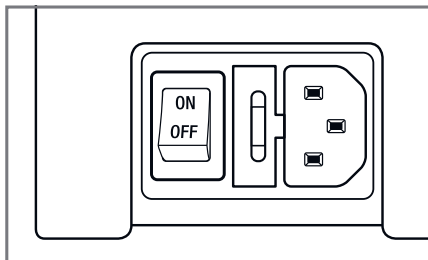

2 Set the desired speed and temperature. When the temperature is reached, the green "ready" light will glow. The following chart gives recommended settings, but as lamination can vary according to your room temperature, the quality of pouch in use and the thickness of its contents, these controls allow you to fine-tune the laminator for perfect results.

Film thickness - microns (μ)	Temperature	Speed
2 x 75 μ (150 μ total)	105°C	6
2 x 125 μ (250 μ total)	130°C	4
2 x 175 μ (350 μ total)	140°C	3
2 x 250 μ (500 μ total)	160°C	2

3 Prepare the item to be laminated. Insert the item to be laminated into a pouch of the correct size and push it right into the sealed end of the pouch. The pouch could jam if the sealed end is not filled. Always insert the pouch into the laminator sealed end first.

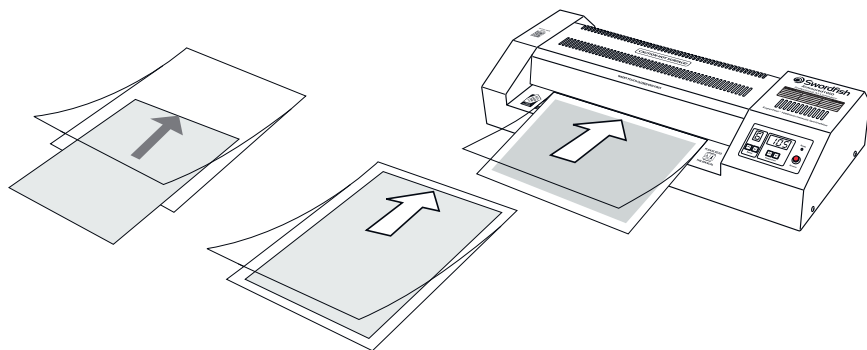

4

**CAUTION**

Lamination pouches are designed for use with full A4, A3, A2 etc. documents. If you wish to laminate non-standard items that do not support the pouch across its entire area, you must use a carrier or there is a real risk that the pouch will jam. Typical instances where a carrier must be used include:

- Multiple items within a single pouch
- Irregular shaped items
- Soft material such as newspaper, tissue, paper and fabrics
- Any item that leaves a border of more than a 3mm around its edges

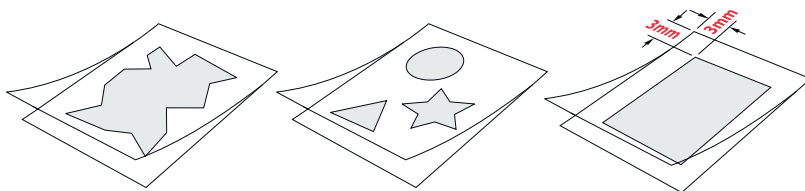

Failure to use a carrier in such cases could cause the pouch to jam. Carriers are available from your usual pouch supplier.

A cardboard carrier will absorb some of the heat so you may need to adjust the temperature or speed settings accordingly.

Swordfish Armoured pouch carriers are made from PTFE-coated micro-fine woven fibreglass and will require little or no temperature adjustment.

Note that the maximum thickness of carrier + pouch + contents **MUST NOT EXCEED 1.2mm**.

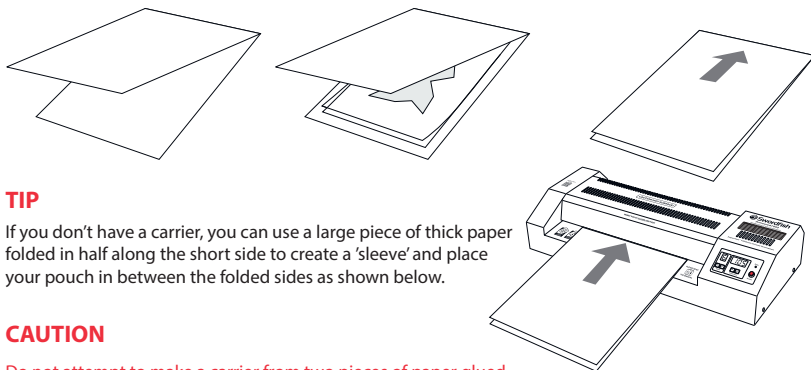
**TIP**

If you don't have a carrier, you can use a large piece of thick paper folded in half along the short side to create a 'sleeve' and place your pouch in between the folded sides as shown below.

CAUTION

Do not attempt to make a carrier from two pieces of paper glued or taped together - it will jam!

5 The laminated item will be transported out of the laminator automatically.



CAUTION

- Do not try to pull the pouch out by force. This may result in creases or curves in the laminated item and may damage the laminator.
- Remove the laminated item and lay it flat.
- The laminated item will be hot. Please handle it with care.

TIPS

If the correct settings are not chosen, the following lamination results may appear. Adjust the setting and try again.

White spots

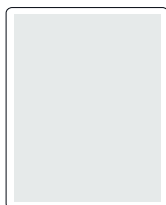

Insufficient heat.
Increase the temperature a little.

Vertical spots

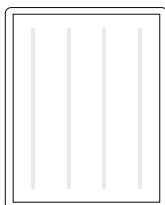

Insufficient heat.
Increase the temperature a little.

Clear & smooth

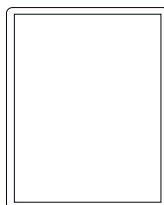

Setting is correct.

Horizontal ripples



Too hot!
Risk of jamming!
Decrease the temperature.

6



IMPORTANT

Never attempt to laminate the following items:

- Leaves or other organic material – moisture will be boiled out, potentially ruining the lamination, damaging the electronics in the machine and creating risk of electric shock.
- Wax crayon drawings – the wax will melt, destroying the drawing. Molten wax could be extruded into the machine and cause extensive damage.
- Documents printed on thermal paper or Polaroid-type instant photos – the images will disappear.
- Any item that is creased or which has irregular thickness – it could cause a jam or damage the rollers.
- Artwork assembled with glue or incorporating glitter-glue. The glue will melt and run into the laminator.
- Any item that is not heat-resistant.

7

At the end of your session, set the temperature to 60°C or less. "OFF" will appear in the screen, indicating that the heaters have been turned off, but the rollers will continue to rotate. Allow the machine to run for five minutes before switching off. This will allow the rollers to cool evenly.

NOTE

The laminator will shut down by itself if it is idle for 30 minutes. Press the "power" button again to start up the laminator.



CAUTION

If the laminator is not going to be used for a long time, unplug it from the power socket.

Essential Information

- Never insert a pouch until the previous lamination has been removed from the machine. Failure to do so could cause a jam.
- The maximum capacity of this machine (pouch + contents) is 1.2mm.
- Should a miss-feed or jam occur, press the “reverse button” to eject the pouch.

Cold Lamination

The majority of lamination is done using pouches that are coated with adhesive that melts at high temperature. However, pouches coated with pressure-activated adhesive - so-called cold lamination pouches - are also available.

If you wish to use cold lamination pouches, set the temperature control 60°C or less. The LED screen will say “OFF”, indicating that the heaters have been switched off but the rollers will turn. If the laminator has recently been used for hot lamination, allow at least one hour for it to cool before starting cold lamination.

Auto Shut-Off Feature

In order to save energy, the heating elements will switch off after 30 minutes of inactivity. After a further 15 minutes, the speed indicator will flash and the motor will stop running. Press any button to re-start the laminator.

Maintenance

We recommend that you regularly inspect the rollers for signs of pouch adhesive on the rollers and remove it with a soft cloth and alcohol (surgical spirit, rubbing alcohol or methylated spirit) when necessary. Do not use white spirit, petrol or any other solvents as they could damage the silicone rollers. Do not use sharp or abrasive tools when cleaning the rollers.

The inner faces of lamination pouches are coated with an adhesive that becomes molten at high temperatures. When a pouch is completely filled, this adhesive will usually be absorbed by the paper in the pouch. However, some adhesive may be squeezed out of the pouch and onto the rollers. If a pouch is not completely filled, a great deal of adhesive can be squeezed out onto the rollers.



IMPORTANT

Sticky rollers can cause pouches to jam, so it is important to keep them clean.

To access the rollers, disconnect the machine from the electricity supply, allow it to cool, and then remove the top cover which is retained by two Phillips screws at the back. Use caution if the machine has been used recently – the top cover, the rollers and adjacent components may still be hot!

If you wish to clean the rollers while they are turning, first reduce the temperature to 60° or less. The word “OFF” will appear in the control panel, indicating that the heaters have been turned off, but the rollers will continue to turn.

Allow the machine to cool before removing the top cover, which is retained by two Phillips screws on the back of the machine. Remove the top cover only. Do not further dismantle the machine – risk of electric shock! Use extreme caution – take care that hair, clothing, jewellery, etc., does not become trapped by the rollers.

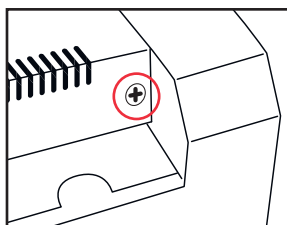

Phillips Screw x2 at the rear

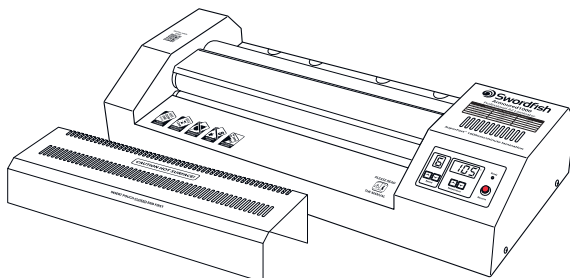

Cleaning

The outer case of the machine may be wiped clean with a moist cloth. Do not allow water to spill inside the laminator – risk of electric shock.



IMPORTANT

Do not use aerosol cleaners – or any other aerosol product – on, or near, this machine (or any other electrical appliance) as the propellant may be flammable.

Troubleshooting

The POWER light does not glow when the laminator is turned on.

Please ensure that the plug is firmly inserted into the power socket. Check that the isolating switch on the back of the machine is in the “on” position.

White spots or cloudy areas appear on the lamination.

The temperature of the machine is too low – the adhesive inside the pouch has not melted completely. Either use a thinner pouch or raise the temperature – by small increments – until perfect results are achieved.

The lamination is creased, rippled or wavy.

The temperature of the laminator is too high. Decrease the temperature or use a thicker pouch.

The edges of the pouch are wavy.

If a number of smaller pouches have previously been laminated, the temperature of the rollers will be uneven. Allow the machine to run for a few minutes so that the temperature can stabilise.

If a pouch becomes jammed in the laminator.

Press and hold the “reverse” button. Pull the pouch gently, if necessary, but do not use excessive force as this could damage the laminator mechanism. If the jammed pouch cannot be removed, turn the laminator off immediately and contact your retailer for assistance. **Do not attempt to dismantle the laminator as this will invalidate your warranty and expose you to the risk of burn injuries and electric shock.**



To get the best results from your laminator and to avoid common lamination problems, scan this code with your smartphone.

Have you seen the rest of the Swordfish range?

Pencil Sharpeners



The Triple



Pointi



VariPoint

Paper Shredders



800XC



1200XXCD

Paper Trimmers



SlimLine Series
A4, A3



Elite Series
A3/A2

To find out more information on the full range of products, visit us at www.snopakebrands.com

