

PHILIPS

Brilliance

346P1



www.philips.com/welcome

EN	User manual	1
	Customer care and warranty	32
	Troubleshooting & FAQs	36

Table of Contents

1. Important	1	10.1 Philips' Flat Panel Displays Pixel Defect Policy	32
1.1 Safety precautions and maintenance	1	10.2 Customer Care & Warranty	35
1.2 Notational Descriptions	3		
1.3 Disposal of product and packing material	3		
2. Setting up the monitor	5	11. Troubleshooting & FAQs	36
2.1 Installation	5	11.1 Troubleshooting	36
2.2 Operating the monitor	8	11.2 General FAQs	37
2.3 Built-in Windows Hello™ pop-up webcam	12	11.3 Multiview FAQs	40
2.4 MultiClient Integrated KVM	14		
2.5 MultiView	15		
2.6 Remove the Base Assembly for VESA Mounting	17		
3. Image Optimization	18		
3.1 SmartImage	18		
3.2 SmartContrast	19		
3.3 Adaptive Sync	20		
4. HDR	21		
5. Designs to prevent computer vision syndrome (CVS)	22		
6. PowerSensor™	23		
7. Daisy-chain function	25		
8. Technical Specifications	27		
8.1 Resolution & Preset Modes	30		
9. Power Management	31		
10. Customer care and warranty	32		

1. Important

This electronic user's guide is intended for anyone who uses the Philips monitor. Take time to read this user's manual before you use your monitor. It contains important information and notes regarding the operation of your monitor.

The Philips guarantee applies provided the product is handled properly for its intended use, in accordance with its operating instructions and upon presentation of the original invoice or cash receipt, indicating the date of purchase, dealer's name and model and production number of the product.

1.1 Safety precautions and maintenance

Warnings

[Use of controls, adjustments or procedures other than those specified in this documentation may result in exposure to shock, electrical hazards and/or mechanical hazards.](#)

[Read and follow these instructions when connecting and using your computer monitor.](#)

Operation

- Please Keep the monitor out of direct sunlight, very strong bright lights and away from any other heat source. Lengthy exposure to this type of environment may result in discoloration and damage to the monitor.
- Keep the display away from oil. Oil may damage the plastic cover of the display and void the warranty.
- Remove any object that could fall into ventilation holes or prevent

proper cooling of the monitor's electronics.

- Do not block the ventilation holes on the cabinet.
- When positioning the monitor, make sure the power plug and outlet are easily accessible.
- If turning off the monitor by detaching the power cable or DC power cord, wait for 6 seconds before attaching the power cable or DC power cord for normal operation.
- Please use approved power cord provided by Philips at all times. If your power cord is missing, please contact your local service center. (Please refer to Service contact information listed in Important information manual.)
- Do not subject the monitor to severe vibration or high impact conditions during operation.
- To avoid potential damage, for example the panel peeling from the bezel, ensure that the monitor does not tilt downward by more than -5 degrees. If the -5 degree downward tilt angle maximum is exceeded, the monitor damage will not be covered under warranty.
- Do not knock or drop the monitor during operation or transportation.
- The USB Type-C port could only be connected to specify equipment with fire enclosure in compliance with IEC 62368-1 or IEC 60950-1.

Maintenance

- To protect your monitor from possible damage, do not put excessive pressure on the LCD panel. When moving your monitor, grasp the frame to lift; do not lift the monitor by placing your hand or fingers on the LCD panel.

i. Important

- Oil-based cleaning solutions may damage the plastic parts and void the warranty.
- Unplug the monitor if you are not going to use it for an extensive period of time.
- Unplug the monitor if you need to clean it with a slightly damp cloth. The screen may be wiped with a dry cloth when the power is off. However, never use organic solvent, such as, alcohol, or ammonia-based liquids to clean your monitor.
- To avoid the risk of shock or permanent damage to the set, do not expose the monitor to dust, rain, water, or excessive moisture environment.
- If your monitor gets wet, wipe it with dry cloth as soon as possible.
- If foreign substance or water gets in your monitor, please turn the power off immediately and disconnect the power cord. Then, remove the foreign substance or water, and send it to the maintenance center.
- Do not store or use the monitor in locations exposed to heat, direct sunlight or extreme cold.
- In order to maintain the best performance of your monitor and use it for a longer lifetime, please use the monitor in a location that falls within the following temperature and humidity ranges.
 - Temperature: 0–40°C 32–104°F
 - Humidity: 20–80% RH

Important information for Burn-in/ Ghost image

- Always activate a moving screen saver program when you leave your monitor unattended. Always

activate a periodic screen refresh application if your monitor will display unchanging static content. Uninterrupted display of still or static images over an extended period may cause “burn in”, also known as “after-imaging” or “ghost imaging”, on your screen.

- “Burn-in”, “after-imaging”, or “ghost imaging” is a well-known phenomenon in LCD panel technology. In most cases, the “Burn-in” or “after-imaging” or “ghost imaging” will disappear gradually over a period of time after the power has been switched off.

Warning

Failure to activate a screen saver, or a periodic screen refresh application may result in severe “burn-in” or “after-image” or “ghost image” symptoms that will not disappear and cannot be repaired. The damage mentioned above is not covered under your warranty.

Service

- The casing cover should be opened only by qualified service personnel.
- If there is any need for any document for repair or integration, please contact with your local service center. (Please refer to Service contact information listed in Important information manual.)
- For transportation information, please refer to “Technical Specifications”.
- Do not leave your monitor in a car/trunk under direct sun light.

Note

Consult a service technician if the monitor does not operate normally, or you are not sure what procedure to take

i. Important

when the operating instructions given in this manual have been followed.

1.2 Notational Descriptions

The following subsections describe notational conventions used in this document.

Notes, Cautions and Warnings

Throughout this guide, blocks of text may be accompanied by an icon and printed in bold or italic type. These blocks contain notes, cautions or warnings. They are used as follows:

Note

This icon indicates important information and tips that help you make better use of your computer system.

Caution

This icon indicates information that tells you how to avoid either potential damage to hardware or loss of data.

Warning

This icon indicates the potential for bodily harm and tells you how to avoid the problem.

Some warnings may appear in alternate formats and may not be accompanied by an icon. In such cases, the specific presentation of the warning is mandated by the relevant regulatory authority.

1.3 Disposal of product and packing material

Waste Electrical and Electronic Equipment-WEEE



This marking on the product or on its packaging illustrates that, under European Directive 2012/19/EU governing used electrical and electronic appliances, this product may not be disposed of with normal household waste. You are responsible for disposal of this equipment through a designated waste electrical and electronic equipment collection. To determine the locations for dropping off such waste electrical and electronic, contact your local government office, the waste disposal organization that serves your household or the store at which you purchased the product.

Your new monitor contains materials that can be recycled and reused. Specialized companies can recycle your product to increase the amount of reusable materials and to minimize the amount to be disposed of.

All redundant packing material has been omitted. We have done our utmost to make the packaging easily separable into mono materials.

Please find out about the local regulations on how to dispose of your old monitor and packing from your sales representative.

i. Important

Taking back/Recycling Information for Customers

Philips establishes technically and economically viable objectives to optimize the environmental performance of the organization's product, service and activities.

From the planning, design and production stages, Philips emphasizes the important of making products that can easily be recycled. At Philips, end-of-life management primarily entails participation in national take-back initiatives and recycling programs whenever possible, preferably in cooperation with competitors, which recycle all materials (products and related packaging material) in accordance with all Environmental Laws and taking back program with the contractor company.

Your monitor is manufactured with high quality materials and components which can be recycled and reused.

To learn more about our recycling program please visit

<http://www.philips.com/a-w/about/sustainability.html>

2. Setting up the monitor

2.1 Installation

1 Package contents



* Stand/Base



* I/O Cover



Power



* CD



* DP



* HDMI



*USB C-C/A



*USB C-C



*USB C-A



*USB A-B

*Different according to region.

2 Install the base

1. In order to well protect this monitor and avoid scratching or damaging of the monitor, keep the monitor face down in the cushion for the base installation.

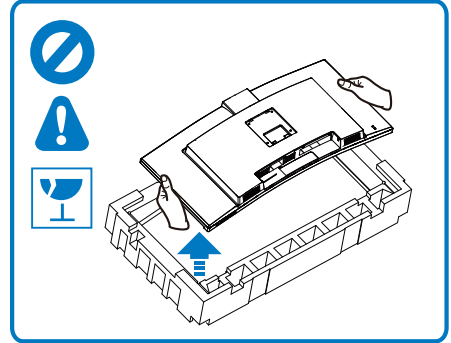
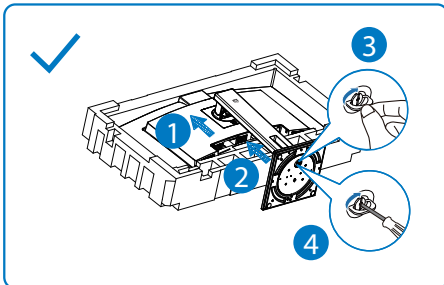

2. Hold the stand with both hands.
 - (1) Gently attach the stand to the VESA mount area until the latch locks the stand. Gently attach the base to the stand.
 - (2) Use your fingers to tighten the screw located at the bottom of the base.
 - (3) Use screwdriver to tighten the screw located at the bottom of the base, and secure the base to the column tightly.
3. After attaching the base, erect the monitor with both hands on holding the monitor together with styrofoam firmly. Now you can pull out the styrofoam. When you pull out the styrofoam, do not squeeze the panel to avoid broken panel.

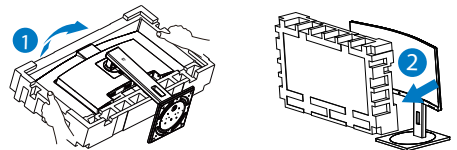

⚠ Warning

This product is curve design, when attach / detach the base, place the protective material under the monitor and do not press down the monitor to avoid the damage.

2. Setting up the monitor

3 Connecting to your PC

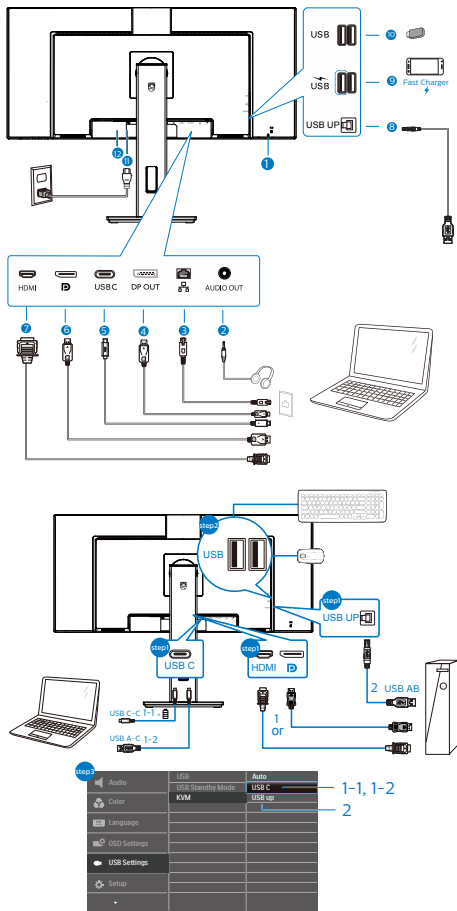

- 1 Kensington anti-theft lock
- 2 Earphone jack
- 3 RJ-45 input
- 4 DisplayPort output
- 5 USB Type C input/Upstream
- 6 DisplayPort input
- 7 HDMI input
- 8 USB upstream
- 9 USB downstream/USB fast charger
- 10 USB downstream

11 AC power input

12 Power Switch

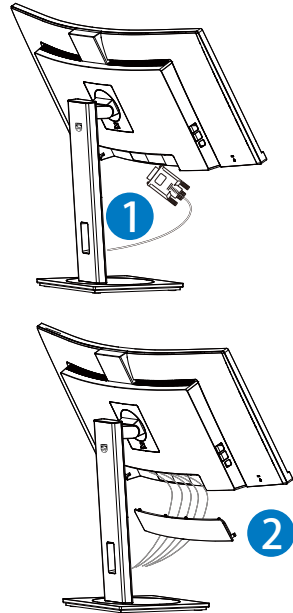

Connect to PC

1. Connect the power cord to the back of the display firmly.
2. Turn off your computer and unplug its power cable.
3. Connect the monitor signal cable to the video connector on the back of your computer.
4. Plug the power cord of your computer and your monitor into a nearby outlet.
5. After connecting cables, slide the I/O cover into the slots on the rear monitor and snap the I/O cover into the place.
6. Turn on your computer and monitor. If the monitor displays an image, installation is complete.

2. Setting up the monitor

Note

While connecting with USB C, it might take 10 seconds to show an image from the monitor.

4 USB C driver installation for RJ45

Before using the USB C docking display, please ensure to install the USB C driver.

You can find the “LAN Drivers” from CD disk if bundled or go to Philips website support page to download the driver.

Please follow the steps for the installation:

1. Install the LAN driver that matches your system.
2. Double click driver to install, and follow Window’s instructions to proceed with installation.
3. It will show “success” when the installation is finished.
4. You must reboot your computer after the installation has completed.
5. Now you will be able to see “Realtek USB Ethernet Network Adapter” from your program installed list.
6. We recommend to periodically visit the above web link to check for the availability of the most updated driver.

Note

Please contact Philips service hotline for Mac address clone tool as necessary.

5 USB hub

To comply with International energy standards, the USB hub/ports of this monitor are disabled during Standby and Off modes.

Connected USB devices will not work in this state.

To permanently put the USB function in “ON” state, please go to OSD Menu, then select “USB standby mode”, and switch it to “ON” state. Somehow if your monitor reset to factory setting, ensure to select “USB standby mode” to “ON” state in OSD menu.

6 USB charging

This monitor has USB ports capable of standard power output including some with USB Charging function (identifiable with power icon ). You can use these ports to charge your Smart phone or power your external HDD, for example. The monitor must be powered ON at all times to be able to use this function.

Some select Philips monitors may not Power or Charge your device when it enters to “Sleep/Standby” mode (White power LED blinking). In that case, please enter to OSD Menu and select “USB Standby Mode”, then, turn the function to “ON” mode (default=OFF). This will then keep the USB power and charging functions active even when the monitor is in sleep/Standby mode.

Audio	USB	On <input checked="" type="checkbox"/>
	USB Standby Mode	Off
Color	KVM	
Language		
OSD Settings		
USB Settings		
Setup		
^		

Note

If you Turn OFF your monitor via the power switch at any given time, all the USB ports will power OFF.

Warning

USB 2.4Ghz wireless devices, such as, wireless mouse, keyboard, and headphones, maybe have interference by USB3.0 or higher version, the high-speed signal devices, which may result in a decreased efficiency of the radio transmission. Should this happen, please try the following methods to help reduce the effects of interference.

- Try to keep USB2.0 receivers away from USB3.0 or higher version of connection port.
- Use a standard USB extension cable or USB hub to increase the space between your wireless receiver and the USB3.0 or higher version of connection port.

2.2 Operating the monitor

1 Description of the control buttons

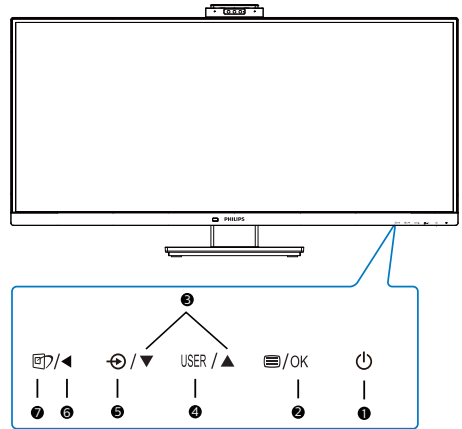

1		Switch monitor's power ON or OFF.
2		Access the OSD menu. Confirm the OSD adjustment.
3		Adjust the OSD menu.
4	USER	User preference key. Customize your own preference function from OSD to become the "user key".
5		Change the signal input source.
6		Return to previous OSD level.
7		SmartImage hot key. There are multiple modes to select: EasyRead, Office, Photo, Movie, Game, Economy, LowBlue Mode, SmartUniformity, Off.

2. Setting up the monitor

2 Webcam

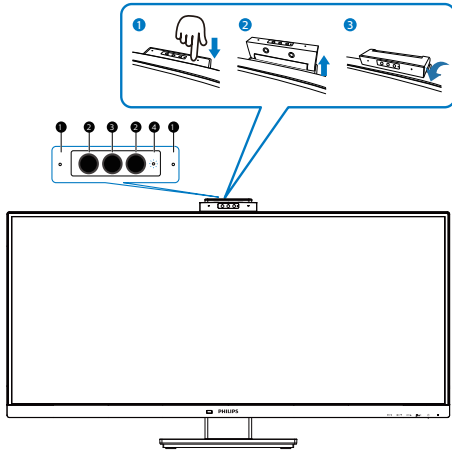







1	Microphone
2	IR of Face identification
3	2.0 Megapixel Webcam
4	Webcam activity light

3 Customize your own “USER” key

This hot key allows you to setup your favorite function key.

1. Press  button on the front bezel to enter OSD Menu Screen.

Audio	Horizontal	Audio Source
	Vertical	Volume
Color	Transparency	PowerSensor <input checked="" type="checkbox"/>
	OSD Time Out	Brightness
Language	User Key	Multi View
		KVM
OSD Settings		
USB Settings		
Setup		
	^	

2. Press  or  button to select main menu [**OSD Settings**], then press **OK** button.
3. Press  or  button to select [**User Key**], then press **OK** button.
4. Press  or  button to select your preferred function.
5. Press **OK** button to confirm your selection.

Now you can press the hotkey directly on the front bezel. Only your pre-selected function will appear for quick access.

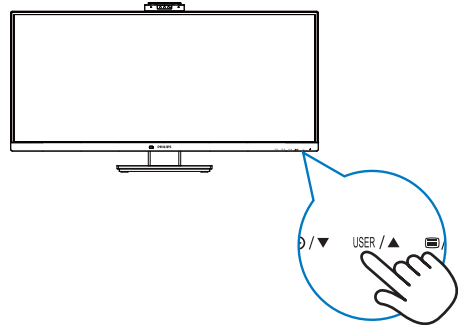

2. Setting up the monitor

4 Description of the On Screen Display

What is On-Screen Display (OSD)?

On-Screen Display (OSD) is a feature in all Philips LCD monitors. It allows an end user to adjust screen performance or select functions of the monitors directly through an on-screen instruction window. A user friendly on screen display interface is shown as below:

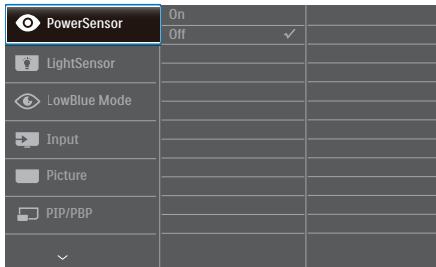

Basic and simple instruction on the control keys

In the OSD shown above, you can press ▼▲ buttons at the front bezel of the monitor to move the cursor, and press OK button to confirm the choice or change.

The OSD Menu

Below is an overall view of the structure of the On-Screen Display. You can use this as a reference when you want to work your way around the different adjustments later on.

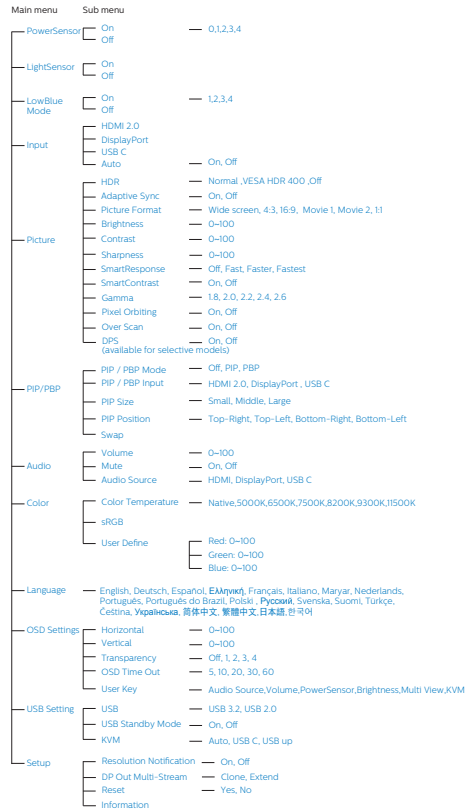

2. Setting up the monitor

5 Resolution notification

This monitor is designed for optimal performance at its native resolution, 3440x1440@60Hz. When the monitor is powered on at a different resolution, an alert is displayed on screen: Use 3440x1440@60Hz for best results. Display of the native resolution alert can be switched off from Setup in the OSD (On Screen Display) menu.

Note

1. The USB hub default setting of USB C input for this monitor is "USB 3.2". The maximum resolution supported depends on your graphic card capability. If your PC doesn't support HBR 3, select USB 2.0 in USB Setting, then the maximum resolution supported will be 3440 x 1440 @100Hz. Press  button > USB Setting > USB > USB 2.0
2. If your Ethernet connection seems slow, please enter OSD menu and select USB3.2 which supports the LAN speed to 1G.

6 Physical Function

Tilt

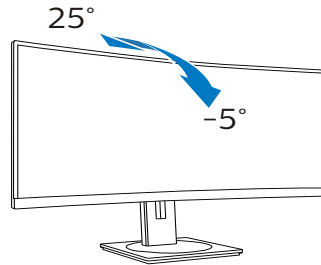

Swivel

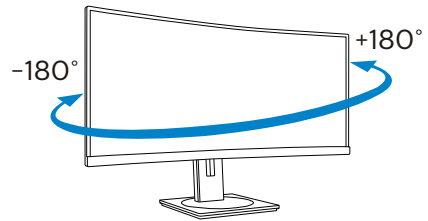

Height adjustment

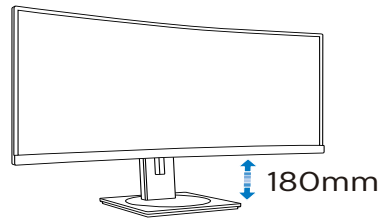

Warning

- To avoid potential screen damage, such as panel peeling, ensure that the monitor does not tilt downward by more than -5 degrees.
- Do not press the screen while adjusting the angle of the monitor. Grasp only the bezel.

2.3 Built-in Windows Hello™ pop-up webcam

1 What is it?

Philips' innovative and secure webcam pops up when you need it and securely tucks back into the monitor when you are not using it. The webcam is also equipped with advanced sensors for Windows Hello facial recognition, which conveniently logs you into your Windows devices in less than 2 seconds, 3 times faster than a password.

2 How to enable Windows Hello™ pop-up webcam

Philips monitor with Windows Hello webcam can be enabled by simply connecting your USB cable from your PC to the “USB C” port or “USB up” port of this monitor, then make a selection accordingly from the “KVM” section of your OSD menu. Now, the webcam with Windows Hello is ready to work as long as the Windows Hello setting in Windows10 is complete. Refer to Windows official website for the settings: <https://support.microsoft.com/help/4028017/windows-learn-about-windows-hello-and-set-it-up>

Please note that Windows 10 system is required for setting up Windows Hello: facial recognition; with an edition lower than Windows 10 or Mac OS, the webcam can work without the function of facial recognition. With Windows7 the driver is required to activate this webcam.

Operating System	Webcam	Windows hello
Win7	Yes	No
Win8	Yes	No
Win8.1	Yes	No
Win10	Yes	Yes

Please follow the steps for the setting:

1. Press the built-in webcam on the top of this monitor, and turn it to the front.

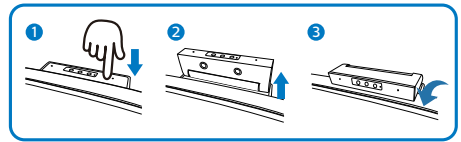

2. Simply connect the USB cable from your PC to the “USB C” or “USB UP” port of this monitor

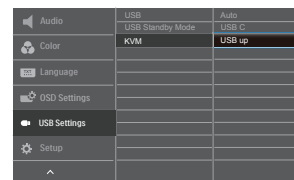
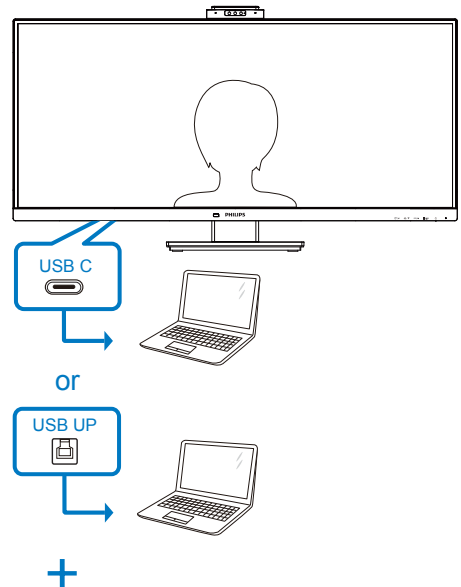

3. Setting in Windows 10 for Windows Hello
 - a. In the settings app click on accounts.

2. Setting up the monitor

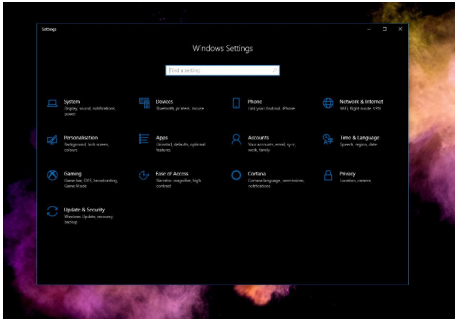

- b. Click on sign-in options in the sidebar.
- c. You need to set up a PIN code before you're allowed to use Windows Hello. Once you've added this, the option for Hello will unlock.

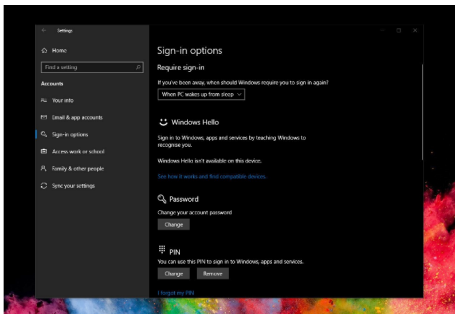

- d. You'll now see which options are available to set up under Windows Hello.

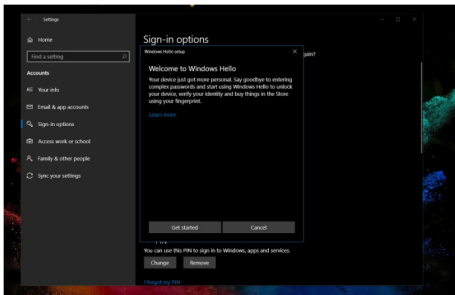

- e. Click on "Get started." The setting is complete.

4. If you connect the USB cable from "USB up" port of this monitor, please enter OSD menu to make a appropriate selection of "USB up" under the "KVM" layer.

Audio	USB USB Standby Mode	Auto USB C
Color	KVM	USB up
Language		
DSD Settings		
USB Settings		
Setup		

Note

1. Please always go to Windows official website to access the latest information, the information in EDFU is subject to change without further notice.
2. Different regions have different voltages, with inconsistent voltage setting may cause water ripple when using this webcam. Please make the voltage setting same as the voltage of your region.

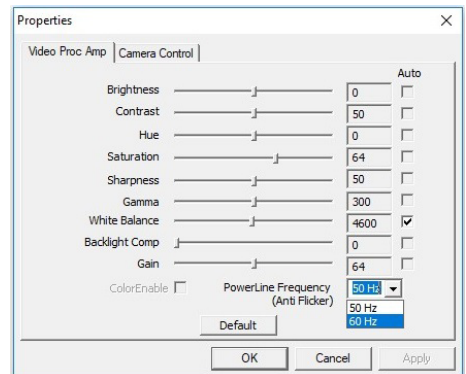

2.4 MultiClient Integrated KVM

1 What is it?

With MultiClient Integrated KVM switch, you can control two separate PCs with one monitor-keyboard-mouse set up. A convenient button allows you to quickly switch between sources. Handy with set-ups that require dual PC computing power or sharing one large monitor to show two different PCs.

2 How to enable MultiClient Integrated KVM

With the built-in MultiClient Integrated KVM, Philips monitor allows to quickly switch your peripherals back and forth between in two devices through the OSD menu setting.

Please follow the steps for the settings.

1. Connect the USB upstream cable from your dual devices to the “USB C” and “USB up” port of this monitor at the same time.
2. Connect peripherals to the USB downstream port of this monitor.

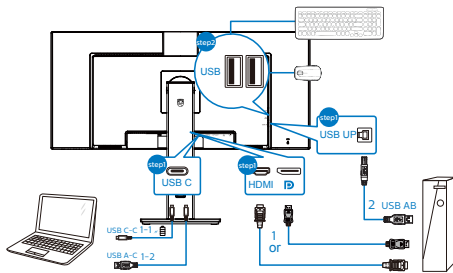

3. Enter to OSD menu. Go to KVM layer and select “Auto”, “USB C” or “USB up” to switch the control of peripherals from one device to another. Simply repeat this step for switching the control system using one set of peripheral.

KVM Auto:

Source	USB Hub
HDMI/DP	USB UP
USB C	USB C

Audio	USB	Auto
	USB Standby Mode	USB C
Color	KVM	USB up
Language		
OSD Settings		
USB Settings		
Setup		

Note

You can also adopt “MultiClient Integrated KVM” in PBP mode, when you enable PBP, you can see two different sources projected to this monitor side by side simultaneously. “MultiClient Integrated KVM” enhances your operation by using one set of peripherals to control between in two systems through the OSD menu setting. Follow step3 as mentioned above.

2.5 MultiView

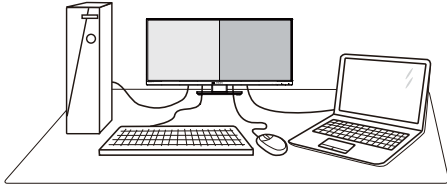

1 What is it?

Multiview enables active dual connect and view so that you can work with multiple devices like PC and Notebook side-by-side simultaneously, making complex multi-tasking work a breeze.







2 Why do I need it?

With the ultra high resolution Philips MultiView display, you can experience a world of connectivity in a comfortable way in the office or at home. With this display, you can conveniently enjoy multiple content sources at one screen. For example: You may want to keep an eye on the live news video feed with audio in the small window, while working on your latest blog, or you may want to edit an Excel file from your Ultrabook, while logged into secured company intranet to access files from a desktop.

3 How to enable MultiView by OSD menu?

1. Press  button on the front bezel to enter OSD Menu Screen.

PowerSensor	PIP/PBP Mode	
	PIP/PBP Input	
LightSensor	PIP Size	
	PIP Position	
LowBlue Mode	Swap	
Input		
Picture		
PIP/PBP		
▼		

2. Press  or  button to select main menu [PIP / PBP], then press **OK** button.
3. Press  or  button to select [PIP / PBP Mode], then press **OK** button.
4. Press  or  button to select [PIP] or [PBP].
5. Now you can move backward to set the [PIP / PBP Input], [PIP Size], [PIP Position], or [Swap].
6. Press **OK** button to confirm your selection.

4 MultiView in OSD menu

- **PIP / PBP Mode:** There are two modes for MultiView: **[PIP]** and **[PBP]**.

[PIP]: Picture in Picture

Open up a sub-window of another signal source.

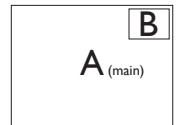

When the sub source is not detected:

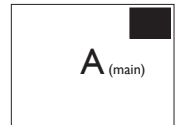

[PBP]: Picture by Picture

Open up a sub-window side-by-side of another signal source.

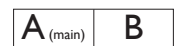

When the sub source is not detected:



2. Setting up the monitor

Note

The black strip shows on the top and the bottom of the screen for the correct aspect ratio when in the PBP mode. If you expect to see full screen side by side, adjust your devices resolutions as pop up attention resolution, you will be able to see 2 devices source screen project to this display side by side without black strips. Note the analog signal is not support this full screen in PBP mode.

- **PIP / PBP Input:** There are three different video input to choose as the sub display source: [HDMI], [DisplayPort], and [USB C].

Please refer below table for compatibility of main/sub input source.

		SUB SOURCE POSSIBILITY (xL)			
		Inputs	HDMI	DisplayPort	USB C
MAIN SOURCE (xL)	HDMI	•	•	•	
	DisplayPort	•	•	•	
	USB C	•	•	•	

- **PIP Size:** When PIP is activated, there are three sub-window sizes to choose: [Small], [Middle], [Large].

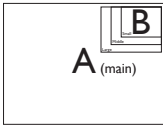

- **PIP Position:** When PIP is activated, there are four sub-window positions to choose.

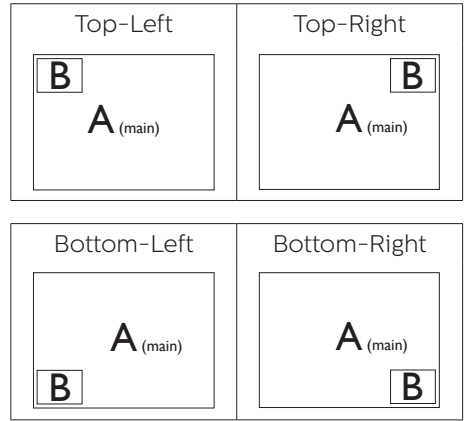

- **Swap:** The main picture source and the sub picture source swapped on the display.

Swap A and B source in [PIP] mode:

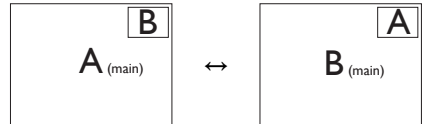

Swap A and B source in [PBP] mode:

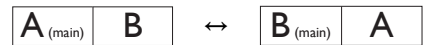

- **Off:** Stop MultiView function.



Note

1. When you do the SWAP function, the video and its audio source will swap at the same time.
2. HDR and DP Out Multi-Stream cannot work with PIP/PBP (MultiView) simultaneously.

2.6 Remove the Base Assembly for VESA Mounting

Before you start disassembling the display base, please follow the instructions below to avoid any possible damage or injury.

1. Place the monitor face down on a smooth surface. Pay attention not to scratch or damage the screen.

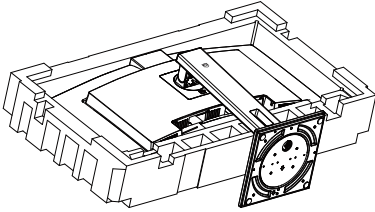

2. While keeping the release button pressed, tilt the base and slide it out.

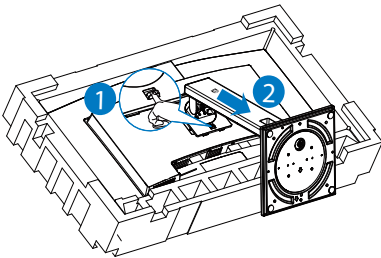

Note

This monitor accepts a 100mm x 100mm VESA-Compliant mounting interface.

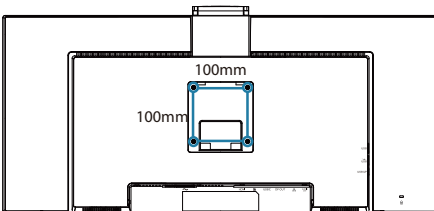

Warning

This product is curve design, when attach / detach the base, place the protective material under the monitor and do not press down the monitor to avoid the damage.

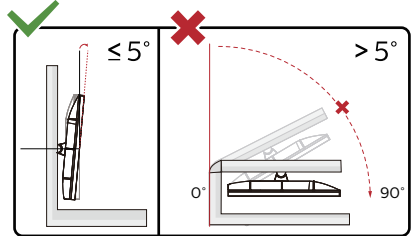

* Display design may differ from those illustrated.

Warning

- To avoid potential screen damage, such as panel peeling, ensure that the monitor does not tilt downward by more than -5 degrees.
- Do not press the screen while adjusting the angle of the monitor. Grasp only the bezel.

3. Image Optimization

3.1 SmartImage

1 What is it?

SmartImage provides presets that optimize display for different types of content, dynamically adjusting brightness, contrast, color and sharpness in real time. Whether you're working with text applications, displaying images or watching a video, Philips SmartImage delivers great optimized display performance.

2 Why do I need it?

You want a display that delivers optimized display all your favorite types of content, SmartImage software dynamically adjust brightness, contrast, color and sharpness in real time to enhance your display viewing experience.

3 How does it work?

SmartImage is an exclusive, leading edge Philips technology that analyzes the content displayed on your screen. Based on a scenario you select, SmartImage dynamically enhances the contrast, color saturation and sharpness of images to enhance the contents being displayed - all in real time with the press of a single button.

4 How to enable SmartImage?

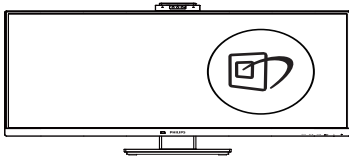

1. Press  to launch the SmartImage on screen display.
2. Keep pressing   to toggle among

Office, Photo, Movie, Game, Economy, SmartUniformity and Off.

3. The SmartImage on screen display will remain on screen for 5 seconds, or you can also press "OK" to make confirmation.

There are multiple modes to select: EasyRead, Office, Photo, Movie, Game, Economy, LowBlue Mode, SmartUniformity and Off.

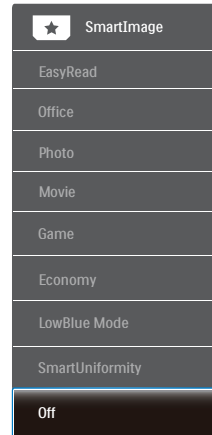

- **EasyRead:** Helps improve reading of text based application like PDF ebooks. By using a special algorithm which increases the contrast and boundary sharpness of text content, the display is optimized for a stress-free reading by adjusting the brightness, contrast and color temperature of the monitor.
- **Office:** Enhances text and dampens brightness to increase readability and reduce eye strain. This mode significantly enhances readability and productivity when you're working with spreadsheets, PDF files, scanned articles or other general office applications.
- **Photo:** This profile combines color saturation, dynamic contrast and sharpness enhancement to display photos and other images with



3. Image Optimization

- outstanding clarity in vibrant colors
– all without artifacts and faded colors.
- **Movie:** Ramped up luminance, deepened color saturation, dynamic contrast and razor sharpness displays every details in darker areas of your videos without color washout in brighter areas maintaining a dynamic natural values for the ultimate video display.
- **Game:** Turn on over drive circuit for best response time, reduce jaggy edges for fast moving objects on screen, enhance contrast ratio for bright and dark scheme, this profile delivers the best gaming experience for gamers.
- **Economy:** Under this profile, brightness, contrast are adjusted and backlighting finetuned for just right display of everyday office applications and lower power consumption.
- **LowBlue Mode:** LowBlue Mode for easy on-the-eyes productivity Studies have shown that just as ultra-violet rays can cause eye damage, shortwave length blue light rays from LED displays can cause eye damage and affect vision over time. Developed for wellbeing, Philips LowBlue Mode setting uses a smart software technology to reduce harmful shortwave blue light.
- **SmartUniformity:** Fluctuations in brightness and color on different parts of a screen are a common phenomenon among LCD monitors. Typical uniformity is measured around 75-80%. By enabling Philips SmartUniformity feature, display uniformity is increased to above 95%. This produces more consistent and true images.

- **Off:** No optimization by SmartImage.



Note

Philips LowBlue mode, mode 2 compliance with TUV Low Blue Light certification, you can have this mode by simply press the hotkey , then press  to select LowBlue Mode, see above SmartImage selection steps.

3.2 SmartContrast

1 What is it?

Unique technology that dynamically analyzes displayed content and automatically optimizes a Display's contrast ratio for maximum visual clarity and viewing enjoyment, stepping up backlighting for clearer, crisper and brighter images or dimming backlighting for clear display of images on dark backgrounds.

2 Why do I need it?

You want the very best visual clarity and viewing comfort for every type of content. SmartContrast dynamically controls contrast and adjusts backlighting for clear, crisp, bright gaming and video images or displays clear, readable text for office work. By reducing your display's power consumption, you save on energy costs and extend the lifetime of your display.

3 How does it work?

When you activate SmartContrast, it will analyse the content you are displaying in real time to adjust colors and control backlight intensity. This function will dynamically enhance contrast for a great entertainment experience when viewing videos or playing games.

3.3 Adaptive Sync



Adaptive Sync

PC gaming has long been an imperfect experience because GPUs and monitors update at different rates. Sometimes a GPU can render many new pictures during a single update of the monitor, and the monitor will show pieces of each picture as a single image. This is called “tearing.” Gamers can fix tearing with a feature called “v-sync,” but the image can become jerky as the GPU waits on the monitor to call for an update before delivering new pictures.

The responsiveness of mouse input and overall frames per second are reduced with v-sync, too. AMD Adaptive Sync technology eliminates all of these problems by letting the GPU update the monitor the moment a new picture is ready, leaving gamers with unbelievably smooth, responsive, tearing-free games.

Followed by the graphic card that are compatible.

- AMD Radeon R7 260X
- AMD Radeon R7 260
- Processor A-Series Desktop and Mobility APUs
 - AMD A10-7890K
 - AMD A10-7870K
 - AMD A10-7850K
 - AMD A10-7800
 - AMD A10-7700K
 - AMD A8-7670K
 - AMD A8-7650K
 - AMD A8-7600
 - AMD A6-7400K



Note

Adaptive Sync might be deactivated while using PIP/PBP (MultiView) or DP Out Multi-Stream

- Operating system
 - Windows 10/8.1/8/7
- Graphic Card: R9 290/300 Series & R7 260 Series
 - AMD Radeon R9 300 Series
 - AMD Radeon R9 Fury X
 - AMD Radeon R9 360
 - AMD Radeon R7 360
 - AMD Radeon R9 295X2
 - AMD Radeon R9 290X
 - AMD Radeon R9 290
 - AMD Radeon R9 285

4. HDR

HDR Settings in Windows10 system.

Steps

1. Right click on the desk top, enter to Display settings.
2. Select the display/monitor.
3. Adjust resolution to 3440x1440
4. Turn the “HDR and WCG” to on mode.
5. Adjust Brightness for SDR content.

Note

Windows10 edition is required; always upgrade to the most updated version. Below linkage is for the further more information from microsoft official website.

<https://support.microsoft.com/en-au/help/4040263/windows-10-hdr-advanced-color-settings>

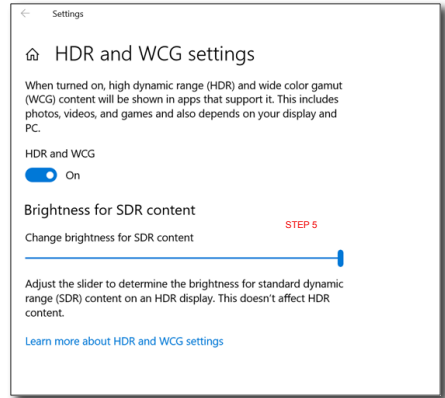
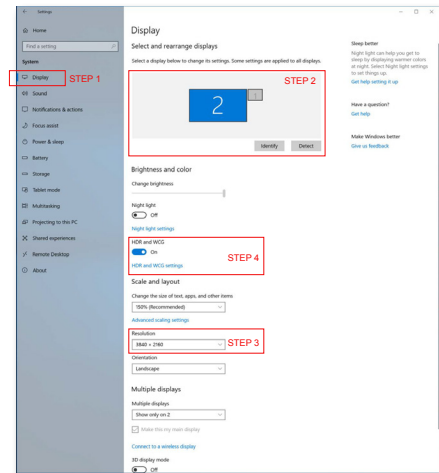

Note

1. HDR and DP Out Multi-Stream cannot work with PIP/PBP (MultiView) simultaneously.
2. HDR is available while connecting with HDMI or DP ports.

5. Designs to prevent computer vision syndrome (CVS)

Philips monitor is designed to prevent eye strain caused by prolonged computer use.

Follow below instructions and use Philips monitor to efficiently reduce fatigue and maximum working productivity.

1. Appropriate environment lighting:

- Adjusting the environment lighting similar to that of your screen brightness, avoid the fluorescent lighting, and surfaces that don't reflect too much light.
- Adjusting the brightness and contrast to appropriate level.

2. Good working habits:

- Excessive usage of monitor can cause eye discomfort, it's better to take shorter breaks more often at your workstation than longer breaks and less often; for example a 5-10 minute break after 50-60-minute continuous screen use is likely to be better than a 15-minute break every two hours.
- Looking at something varying distances after a long period focusing on the screen.
- Gently closing and rolling your eyes to relax.
- Conscious blinking often while working.
- Gently stretch your neck, and slowly tilt your head forward, backward, side for pain relief.

3. Ideal working posture

- Reposition your screen to appropriate height and angle according to your height.

4. Choose Philips monitor for easy-on-eyes.

- Anti-glare screen: Anti-glare screen efficiently reduces annoying and distracting reflections that caused eye fatigue.
- Flicker-free technology designs to regulate brightness and reduce flicker for more comfortable viewing.
- LowBlue mode: Blue light may cause eye strains. Philips LowBlue mode allows you to set different blue light filter levels for variety working situation.
- EasyRead mode for a paper-like reading experience, giving a more comfortable viewing experience while dealing with long documents on the screen.

6. PowerSensor™

1 How does it work?

- PowerSensor works on principle of transmission and reception of harmless “infrared” signals in order to detect user-presence.
- When the user is in front of the monitor, the monitor operates normally, at the predetermined settings that the user has set- i.e. brightness, contrast, color, etc
- Assuming that the monitor was set to 100% of brightness for example, when the user leaves his seat and is no longer in front of the monitor, the monitor automatically reduces the power consumption upto 80%.

User present in front

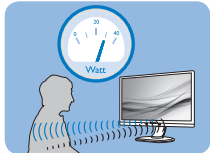

User not present

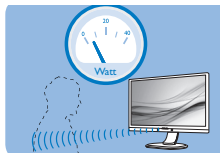

Power consumption as illustrated above is for reference purpose only

2 Setting

Default settings

PowerSensor is designed to detect the presence of the user located between 30 and 100 cm (12 and 40 inches) from the display and within five degrees left or right of the monitor.

Custom settings

If you prefer to be in a position outside the perimeters listed above, choose a higher strength signal for optimal detection efficiency: The higher the setting, the stronger the detection signal. For maximum PowerSensor efficiency and proper detection, please position yourself directly in front of your monitor.

- If you choose to position yourself more than 100 cm or 40 inches from the monitor use the maximum

detection signal for distances up to 120 cm or 47 inches. (Setting 4)

- Since some dark colored clothing tends to absorb infrared signals even when the user is within 100 cm or 40 inches of the display, step up signal strength when wearing black or other dark clothes.

Hot key

(for selected models only)

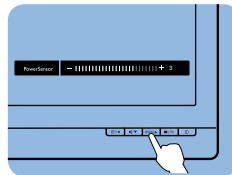

Sensor distance

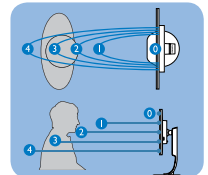

Landscape/Portrait mode

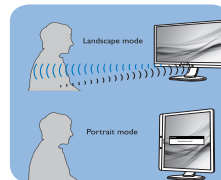

Above illustrations are for reference purpose only, may not reflect the exact display of this model.

3 How to adjust settings

If PowerSensor is not operating correctly inside or outside the default range, here's how to fine-tune detection:

- Enter to OSD menu.
- You will find the adjustment bar.
- Adjust the PowerSensor detection adjustment to Setting 4 and press OK.
- Test the new setup to see if PowerSensor properly detects you in your current position.
- PowerSensor function is designed to work in Landscape mode (horizontal position) only. After PowerSensor turn on it, it will automatically turn Off if the monitor is used in Portrait mode (90 degree/vertical position);

it will automatically turn ON if monitor is returned to its default Landscape position.

Note

A manually selected PowerSensor mode will remain operational unless and until it is readjusted or the default mode is recalled. If you find that the PowerSensor is excessively sensitive to nearby motion for some reason, please adjust to a lower signal strength. Keep sensor lens clean, if the sensor lens is dirty, wipe it with alcohol to avoid reducing of distance detection .

7. Daisy-chain function

DisplayPort Multi-Stream feature enables multiple monitor connections.

This Philips display is equipped with DisplayPort interface and DisplayPort over USB-C which enables daisy-chaining to multiple displays.

To daisy-chain monitors, first to check below:

1. Make sure the GPU on your PC support DisplayPort 1.2 MST (Multi-stream transport).
2. Turn off Adaptive Sync function: press  button, select Picture > Adaptive Sync > Off.

Note

1. Depending on the capabilities of your graphic cards, you should be able to daisy chain multiple displays with various configurations. Your display configurations will depend on your graphic card capabilities. Please check with your graphic card vendor and always update your graphic card driver.
2. HDR and DP Out Multi-Stream cannot work with PIP/PBP (MultiView) simultaneously.

DisplayPort multi-streaming over DisplayPort

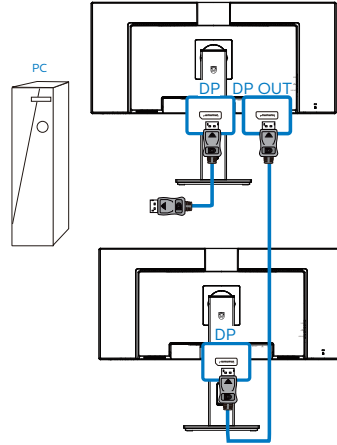

- Select one of DP Out Multi-stream modes:

Press  button, select Setup > DP Out Multi-stream > Extend

Source resolution	Maximum number of external monitors that can be supported
3440 x 1440 @60Hz	1

Note

- To use DisplayPort multi-streaming, you need to set to “Extend mode” on both primary and secondary monitors.
- The secondary monitor in the chain must support DisplayPort multi-streaming, and the maximum resolution support is 3440 x 1440@60Hz.

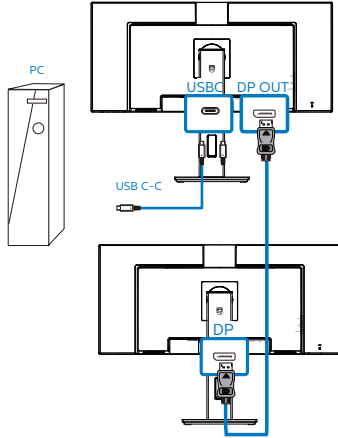

DisplayPort multi-streaming over USB Type-C



- Select one of DP Out Multi-stream modes:

Press  button, select Setup > DP Out Multi-stream > Extend

Source resolution	Link Rate*	Maximum number of external monitors that can be supported
3440 x 1440 @60Hz	HBR2	1
	HBR3	1 (Full HD)**

* To check link rate: press  button, select Setup > information. The screen will show HBR3, otherwise, the link rate is HBR2. If Link rate is not HBR 3, press  button and select USB Setting > USB > USB 2.0 for WQHD resolution on the external monitor.

Note

- We recommend to set USB Setting to USB 3.2, please enter OSD menu and select USB3.2 which supports the LAN speed to 1G.

** Due to bandwidth limitation, the maximum external monitor resolution supported is 1920 x 1080 only.

8. Technical Specifications

Picture/Display	
Display Panel Type	VA
Backlight	W-LED system
Panel Size	34" W (86.36 cm)
Aspect Ratio	21:9
Pixel Pitch	0.23175(W) x 0.23175(H)
Contrast ratio(typical)	3000:1
Optimum Resolution	3440x1440@60Hz
Viewing Angle	178° (H) / 178° (V) @ C/R > 10 (Typ.)
Picture Enhancement	SmartImage
Display Colors	16.7M (8bit)
Vertical Refresh Rate	48-100Hz
Horizontal Frequency	30-160KHz
sRGB	YES
Color Gamut	YES
HDR	VESA Certified DisplayHDR™ 400 (HDMI/DP)
SmartUniformity	YES
Delta E	YES
LowBlue Mode	YES
EasyRead	YES
Adaptive sync	YES
Flicker Free	YES
Connectivity	
Signal Input	DisplayPort 1.4 x 1, HDMI 2.0 x 1
USB	USB-Cx1, USB-Bx1 (upstream) USB3.2 x4 (downstream with x1 fast charge B.C 1.2)
Power Delivery(USB C)	Up to 90W (5V/3A, 7V/3A, 9V/3A, 10V/3A, 12V/3A, 15V/3A, 20V/4.5A)
RJ-45	Ethernet LAN (10M/100M/1000M)
Input Signal	Separate Sync
Audio In/Out	Audio out
USB C docking	
USB-C	Reversible plug connector
Super speed	Data and Video transfer
DP	Built-in DisplayPort Alt mode
Power Delivery	USB PD version 3.0
Max power delivery	Up to 90W (5V/3A, 7V/3A, 9V/3A, 10V/3A, 12V/3A, 15V/3A, 20V/4.5A)
Convenience	
USER convenience	
Built-in speaker	5 W x 2

8. Technical Specifications

Built-in Webcam	2.0 megapixel camera with microphone and LED indicator (for Windows 10 Hello)		
MultiView	PIP/PBP mode, 2×devices		
OSD Languages	English, German, Spanish, Greek, French, Italian, Hungarian, Dutch, Portuguese, Brasil Portuguese, Polish, Russian, Swedish, Finnish, Turkish, Czech, Ukranian, Simplified Chinese, Traditional Chinese, Japanese, Korean		
Other Convenience	VESA mount(100×100mm), Kensington Lock		
Plug & Play Compatibility	DDC/CI, Mac OS X, sRGB, Windows 10/8.1/8/7		
Stand			
Tilt	-5 / +25 degree		
Swivel	-180 / +180 degree		
Height adjustment	180mm		
Power			
Consumption	AC Input Voltage at 100VAC , 50Hz	AC Input Voltage at 115VAC , 60Hz	AC Input Voltage at 230VAC, 50Hz
Normal Operation	55.2 W (typ.)	55.3 W (typ.)	55.4 W (typ.)
Sleep (Standby mode)	<0.3 W(typ.)	<0.3 W(typ.)	<0.3 W(typ.)
Off mode	<0.3 W(typ.)	<0.3 W(typ.)	<0.3 W(typ.)
Off mode(AC switch)	0W(typ.)	0W(typ.)	0W(typ.)
Heat Dissipation*	AC Input Voltage at 100VAC , 50Hz	AC Input Voltage at 115VAC , 60Hz	AC Input Voltage at 230VAC , 50Hz
Normal Operation	188.4 BTU/hr (typ.)	188.7 BTU/hr (typ.)	189.1 BTU/hr (typ.)
Sleep (Standby mode)	<1.02 BTU/hr(typ.)	<1.02 BTU/hr(typ.)	<1.02 BTU/hr(typ.)
Off mode	<1.02 BTU/hr(typ.)	<1.02 BTU/hr(typ.)	<1.02 BTU/hr(typ.)
Off mode(AC switch)	0 BTU/hr(typ.)	0 BTU/hr(typ.)	0 BTU/hr(typ.)
On Mode(ECO mode)	33 W (typ.)		
Power LED indicator	On mode: White, Standby/Sleep mode: White (blinking)		
Power Supply	Built-in, 100–240V AC, 50–60Hz		
Dimensions			
Product with stand (WxHxD)	807 x 601 x 250 mm		
Product without stand (WxHxD)	807 x 367 x 110 mm		
Product with packaging (WxHxD)	930 x 525 x 282 mm		

8. Technical Specifications

Weight	
Product with stand	11.65 kg
Product without stand	7.95 kg
Product with packaging	15.86 kg

Operating Condition	
Temperature range (operation)	0°C to 40 °C
Relative humidity (operation)	20% to 80%
Atmospheric pressure (operation)	700 to 1060hPa
Temperature range (Non-operation)	-20°C to 60°C
Relative humidity (Non-operation)	10% to 90%
Atmospheric pressure (Non-operation)	500 to 1060hPa

Environmental and energy	
ROHS	YES
Packaging	100% recyclable
Specific Substances	100% PVC BFR free housing

Cabinet	
Color	Black
Finish	Texture

Note

1. This data is subject to change without notice. Go to www.philips.com/support to download the latest version of leaflet.
2. SmartUniformity and Delta E information sheets are included in the box.
3. Power delivery function will base on laptop's capability.

8.1 Resolution & Preset Modes

1 Maximum Resolution

3440x1440 @ 100 Hz

2 Recommended Resolution

3440x1440 @ 60 Hz

H. freq (kHz)	Resolution	V. freq (Hz)
31.47	720x400	70.09
31.47	640x480	59.94
35.00	640x480	66.67
37.86	640x480	72.81
37.50	640x480	75.00
35.16	800x600	56.25
37.88	800x600	60.32
48.08	800x600	72.19
46.88	800x600	75.00
47.73	832x624	74.55
48.36	1024x768	60.00
56.48	1024x768	70.07
60.02	1024x768	75.03
44.77	1280x720	59.86
63.89	1280x1024	60.02
79.98	1280x1024	75.03
55.94	1440x900	59.89
65.29	1680x1050	59.95
89.48	1720x1440	59.97
67.50	1920x1080	60.00
113.22	1920x1080	99.93
67.17	2560x1080	59.98
113.24	2560x1080	99.94
44.41	3440x1440	29.99
88.82	3440x1440	59.97
150.97	3440x1440	99.98

Note

- Please notice that your display works best at native resolution of 3440x1440 @ 60Hz. For best display quality, please follow this resolution recommendation.
Recommended resolution HDMI 2.0/DP/USB C: 3440x1440 @ 60Hz
If your display is not on the native resolution when connecting to USB C or DP port, please adjust resolution to the optimal state: 3440x1440 @60 Hz from your PC.
- The factory default setting HDMI supports to the resolution 3440x1440 @ 60Hz.
- The USB hub default setting of USB C input for this monitor is "USB 3.2". The maximum resolution supported depends on your graphic card capability.
If your PC doesn't support HBR 3, select USB 2.0 in USB Setting, then the maximum resolution supported will be 3440 x 1440 @100Hz.
Press  button > USB Setting > USB > USB 2.0

9. Power Management

If you have VESA DPM compliance display card or software installed in your PC, the display can automatically reduce its power consumption when not in use. If an input from a keyboard, mouse or other input device is detected, the display will 'wake up' automatically. The following table shows the power consumption and signaling of this automatic power saving feature:

Power Management Definition					
VESA Mode	Video	H-sync	V-sync	Power Used	LED Color
Active	ON	Yes	Yes	55.3 W (typ.) 242 W (max.)	White
Sleep (Standby mode)	OFF	No	No	<0.3 W (typ.)	White (blink)
Off mode (AC switch)	OFF	-	-	0W (AC switch)	OFF

The following setup is used to measure power consumption on this display.

- Native resolution: 3440x1440
- Contrast: 50%
- Brightness: 60%
- Color temperature: 6500k with full white pattern
- Audio and USB Inactive (Off)

Note

This data is subject to change without notice.

10. Customer care and warranty

10.1 Philips' Flat Panel Displays Pixel Defect Policy

Philips strives to deliver the highest quality products. We use some of the industry's most advanced manufacturing processes and practice stringent quality control. However, pixel or sub pixel defects on the TFT Display panels used in flat panel displays are sometimes unavoidable. No manufacturer can guarantee that all panels will be free from pixel defects, but Philips guarantees that any display with an unacceptable number of defects will be repaired or replaced under warranty. This notice explains the different types of pixel defects and defines acceptable defect levels for each type. In order to qualify for repair or replacement under warranty, the number of pixel defects on a TFT Display panel must exceed these acceptable levels. For example, no more than 0.0004% of the sub pixels on a display may be defective. Furthermore, Philips sets even higher quality standards for certain types or combinations of pixel defects that are more noticeable than others. This policy is valid worldwide.

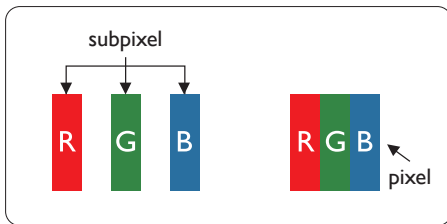

Pixels and Sub pixels

A pixel, or picture element, is composed of three sub pixels in the primary colors of red, green and blue. Many pixels

together form an image. When all sub pixels of a pixel are lit, the three colored sub pixels together appear as a single white pixel. When all are dark, the three colored sub pixels together appear as a single black pixel. Other combinations of lit and dark sub pixels appear as single pixels of other colors.

Types of Pixel Defects

Pixel and sub pixel defects appear on the screen in different ways. There are two categories of pixel defects and several types of sub pixel defects within each category.

Bright Dot Defects

Bright dot defects appear as pixels or sub pixels that are always lit or 'on'. That is, a bright dot is a sub-pixel that stands out on the screen when the display displays a dark pattern. There are the types of bright dot defects.

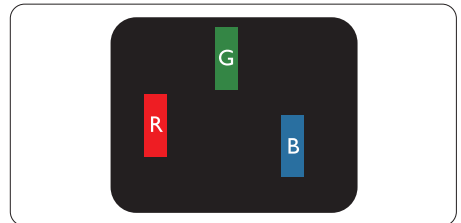

One lit red, green or blue sub pixel.

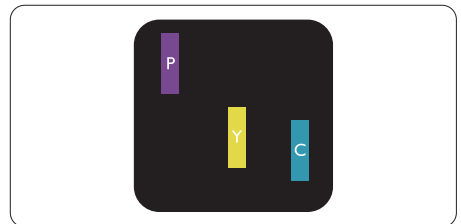

Two adjacent lit sub pixels:

- Red + Blue = Purple
- Red + Green = Yellow
- Green + Blue = Cyan (Light Blue)

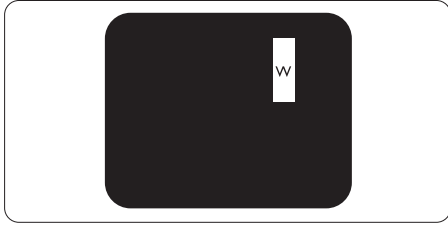

Three adjacent lit sub pixels (one white pixel).

Note

A red or blue bright dot must be more than 50 percent brighter than neighboring dots while a green bright dot is 30 percent brighter than neighboring dots.

Black Dot Defects

Black dot defects appear as pixels or sub pixels that are always dark or 'off'. That is, a dark dot is a sub-pixel that stands out on the screen when the display displays a light pattern. These are the types of black dot defects.

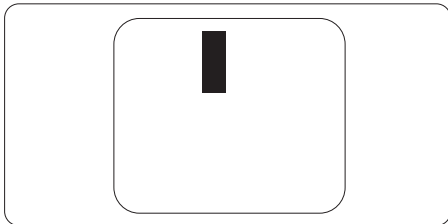

Proximity of Pixel Defects

Because pixel and sub pixels defects of the same type that are near to one another may be more noticeable, Philips also specifies tolerances for the proximity of pixel defects.

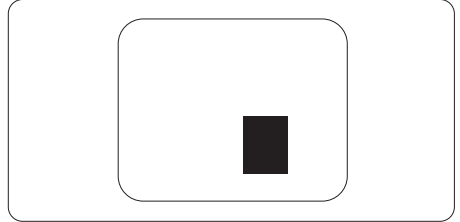

Pixel Defect Tolerances

In order to qualify for repair or replacement due to pixel defects during the warranty period, a TFT Display panel in a Philips flat panel display must have pixel or sub pixel defects exceeding the tolerances listed in the following tables.

BRIGHT DOT DEFECTS	ACCEPTABLE LEVEL
1 lit subpixel	3
2 adjacent lit subpixels	1
3 adjacent lit subpixels (one white pixel)	0
Distance between two bright dot defects*	>15mm
Total bright dot defects of all types	3
BLACK DOT DEFECTS	ACCEPTABLE LEVEL
1 dark subpixel	5 or fewer
2 adjacent dark subpixels	2 or fewer
3 adjacent dark subpixels	0
Distance between two black dot defects*	>15mm
Total black dot defects of all types	5 or fewer
TOTAL DOT DEFECTS	ACCEPTABLE LEVEL
Total bright or black dot defects of all types	5 or fewer

 **Note**

1 or 2 adjacent sub pixel defects = 1 dot defect

10.2 Customer Care & Warranty

For warranty coverage information and additional support requirements valid for your region, please visit www.philips.com/support website for details or contact your local Philips Customer Care Center.

For extended warranty, if you would like to extend your general warranty period, an Out of Warranty service package is offered via our Certified Service Center.

For Warranty Period please refer to Warranty Statement in Important Information Manual.

If you wish to make use of this service, please be sure to purchase the service within 30 calendar days of your original purchase date. During the extended warranty period, the service includes pickup, repair and return service, however the user will be responsible for all costs accrued.

If the Certified Service Partner cannot perform the required repairs under the offered extended warranty package, we will find alternative solutions for you, if possible, up to the extended warranty period you have purchased.

Please contact our Philips Customer Service Representative or local contact center (by Consumer care number) for more details.

Philips Customer Care Center number listed below.

• Local Standard Warranty Period	• Extended Warranty Period	• Total Warranty Period
• Depend on different Regions	• + 1 Year	• Local Standard warranty period +1
	• + 2 Years	• Local Standard warranty period +2
	• + 3 Years	• Local Standard warranty period +3

**Proof of original purchase and extended warranty purchase required.

Note

Please refer to important information manual for regional service hotline, which is available on the Philips website support page.

11. Troubleshooting & FAQs

11.1 Troubleshooting

This page deals with problems that can be corrected by a user. If the problem still persists after you have tried these solutions, contact Philips customer service representative.

1 Common Problems

No Picture (Power LED not lit)

- Make sure the power cord is plugged into the power outlet and into the back of the display.
- First, ensure that the power button on the front of the display is in the OFF position, then press it to the ON position.

No Picture (Power LED is White)

- Make sure the computer is turned on.
- Make sure the signal cable is properly connected to your computer.
- Make sure the display cable has no bent pins on the connect side. If yes, repair or replace the cable.
- The Energy Saving feature may be activated

Screen says

Check cable connection

- Make sure the display cable is properly connected to your computer. (Also refer to the Quick Start Guide).

- Check to see if the display cable has bent pins.
- Make sure the computer is turned on.

Visible signs of smoke or sparks

- Do not perform any troubleshooting steps
- Disconnect the display from mains power source immediately for safety
- Contact with Philips customer service representative immediately.

2 Imaging Problems

Image appears blurred, indistinct or too dark

- Adjust the contrast and brightness on On-Screen Display.

An "after-image", "burn-in" or "ghost image" remains after the power has been turned off.

- Uninterrupted display of still or static images over an extended period may cause "burn in", also known as "after-imaging" or "ghost imaging", on your screen. "Burn-in", "after-imaging", or "ghost imaging" is a well-known phenomenon in LCD panel technology. In most cases, the "Burn-in" or "after-imaging" or "ghost imaging" will disappear gradually over a period of time after the power has been switched off.
- Always activate a moving screen saver program when you leave your display unattended.
- Always activate a periodic screen refresh application if your LCD display will display unchanging static content.
- Failure to activate a screen saver, or a periodic screen refresh application may result in severe "burn-in" or

“after-image” or “ghost image” symptoms that will not disappear and cannot be repaired. The damage mentioned above is not covered under your warranty.

Image appears distorted. Text is fuzzy or blurred.

- Set the PC's display resolution to the same mode as display's recommended screen native resolution.

Green, red, blue, dark, and white dots appears on the screen

- The remaining dots are normal characteristic of the liquid crystal used in today's technology, Please refer the pixel policy for more detail.

* The "power on" light is too strong and is disturbing

- You can adjust “power on” light using the power LED Setup in OSD main Controls.

For further assistance, refer to the Service contact information listed in Important information manual and contact Philips customer service representative.

* [Functionality different according to display.](#)

11.2 General FAQs

Q1: When I install my display what should I do if the screen shows 'Cannot display this video mode'?

Ans.: Recommended resolution for this display: 3440x1440 @ 60 Hz.

- Unplug all cables, then connect your PC to the display that you used previously.

- In the Windows Start Menu, select Settings/Control Panel. In the Control Panel Window, select the Display icon. Inside the Display Control Panel, select the 'Settings' tab. Under the setting tab, in box labelled 'desktop area', move the sidebar to 3440x1440 pixels.
- Open 'Advanced Properties' and set the Refresh Rate to 60 Hz, then click OK.
- Restart your computer and repeat step 2 and 3 to verify that your PC is set at 3440x1440 @ 60 Hz.
- Shut down your computer, disconnect your old display and reconnect your Philips LCD display.
- Turn on your display and then turn on your PC.

Q2: What is the recommended refresh rate for LCD display?

Ans.: Recommended refresh rate in LCD displays is 60 Hz, In case of any disturbance on screen, you can set it up to 75 Hz to see if that removes the disturbance.

Q3: What are the .inf and .icm files on the CD-ROM? How do I install the drivers (.inf and .icm)?

Ans.: These are the driver files for your monitor. Follow the instructions in your user manual to install the drivers. Your computer may ask you for monitor drivers (.inf and .icm files) or a driver disk when you first install your monitor. Follow the instructions to insert the (companion CD-ROM) included in this package. Monitor drivers (.inf and .icm files) will be installed automatically.

Q4: How do I adjust the resolution?

Ans.: Your video card/graphic driver and display together determine the available resolutions. You can select the desired resolution under Windows® Control Panel with the "Display properties".

Q5: What if I get lost when I am making display adjustments via OSD?

Ans.: Simply press  button, then select 'Setup' > 'Reset' to recall all the original factory settings.

Q6: Is the LCD screen resistant to scratches?

Ans.: In general it is recommended that the panel surface is not subjected to excessive shocks and is protected from sharp or blunt objects. When handling the display, make sure that there is no pressure or force applied to the panel surface side. This may affect your warranty conditions.

Q7: How should I clean the LCD surface?

Ans.: For normal cleaning, use a clean, soft cloth. For extensive cleaning, please use isopropyl alcohol. Do not use other solvents such as ethyl alcohol, ethanol, acetone, hexane, etc.

Q8: Can I change the color setting of my display?

Ans.: Yes, you can change your color setting through OSD control as the following procedures,

- Press "OK" to show the OSD (On Screen Display) menu
- Press "Down Arrow" to select the option "Color" then press "OK" to

enter color setting, there are three settings as below.

1. Color Temperature: Native, 5000K, 6500K, 7500K, 8200K, 9300K and 11500K. With settings in the 5000K range the panel appears "warm, with a red-white color tone", while a 11500K temperature yields "cool, bluishwhite toning".
2. sRGB: This is a standard setting for ensuring correct exchange of colors between different device (e.g. digital cameras, displays, printers, scanners, etc).
3. User Define: The user can choose his/her preference color setting by adjusting red, green, blue color.

 **Note**

A measurement of the color of light radiated by an object while it is being heated. This measurement is expressed in terms of absolute scale, (degrees Kelvin). Lower Kelvin temperatures such as 2004K are red; higher temperatures such as 9300K are blue. Neutral temperature is white, at 6504K.

Q9: Can I connect my LCD display to any PC, workstation or Mac?

Ans.: Yes. All Philips LCD displays are fully compatible with standard PCs, Macs and workstations. You may need a cable adapter to connect the display to your Mac system. Please contact your Philips sales representative for more information.

Q10: Are Philips LCD displays Plug-and- Play?

Ans.: Yes, the displays are Plug-and-Play compatible with Windows 10/8.1/8/7

Q11: What is Image Sticking, or Image Burn-in, or After Image, or Ghost Image in LCD panels?

Ans.: Uninterrupted display of still or static images over an extended period may cause "burn in", also known as "after-imaging" or "ghost imaging", on your screen. "Burn-in", "after-imaging", or "ghost imaging" is a well-known phenomenon in LCD panel technology. In most cases, the "Burn-in" or "after-imaging" or "ghost imaging" will disappear gradually over a period of time after the power has been switched off. Always activate a moving screen saver program when you leave your display unattended. Always activate a periodic screen refresh application if your LCD display will display unchanging static content.



Warning



Failure to activate a screen saver, or a periodic screen refresh application may result in severe "burn-in" or "after-image" or "ghost image" symptoms that will not disappear and cannot be repaired. The damage mentioned above is not covered under your warranty.

Q12: Why is my Display not showing sharp text, and is displaying jagged characters?

Ans.: Your LCD display works best at its native resolution of 3440x1440 @ 60 Hz. For best display, please use this resolution.

Q13: How to unlock/lock my hot key?

Ans.: To lock the OSD, press and hold the /OK button while the monitor is off and then press  button to turn the monitor on. To un-lock the OSD, press and

hold the /OK button while the monitor is off and then press  button to turn the monitor on.

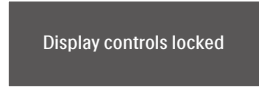
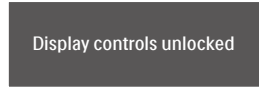

Q14: Where can I find Important Information manual mentioned in EDFU?

Ans.: Important Information manual can be download on the Philips website support page.

Q15: Why cannot detect my monitor's Windows Hello webcam, and also Face Recognition option is greyed out?

Ans: To fix this issue, you need to proceed following steps to detect the webcam device again:

1. Press Ctrl + Shift + ESC to launch the Microsoft Windows Task Manager.
2. Select 'Services' tag.

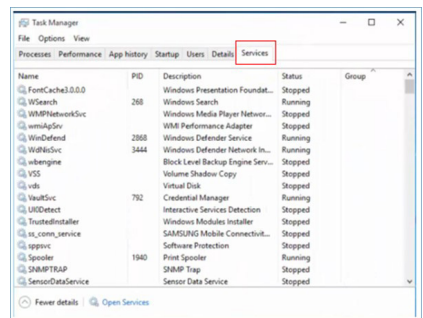

3. Scroll down and select 'WbioSvc' (Windows Biometric Service). If the status shows 'Running', right

click to stop the service first, then restart the service manually.

4. Then go back to sign-in options menu to set up Window Hello Webcam.

Q16: Why I cannot automatically switch to the connected input source after daisy chain over USB-C?

Ans: It's because your primary monitor connects to more than one input source at the same time. When you use the primary monitor to the notebook with USB-C, and also daisy chain to the secondary monitor. Once the notebook goes into standby mode, if you want to show the content from HDMI or DisplayPort, please press  to change the signal input source.

11.3 Multiview FAQs

Q1: How to listen to Audio, independent of video?

Ans.: Normally the audio source is linked to the main picture source. If you want to change audio-source input (for example: listen to your MP3 player independently regardless of the video source input), you can press  to enter OSD menu. Select your preferred [Audio Source] option from the [Audio] main menu.

Please note that the next time you turn on your Display, the Display will by default select the audio source you chose last time. In case you want to change it again, you need to go through the above steps to select your new preferred audio source, which then will become the "default" mode.

Q2: Why the sub-windows flickers when I enable PBP.

Ans: It's because the sub-windows video source is interlace timing(i-timing), please change sub-window signal source to be progressive timing(P-timing).



2019 © TOP Victory Investments Ltd. All rights reserved.

This product has been manufactured by and is sold under the responsibility of Top Victory Investments Ltd., and Top Victory Investments Ltd. is the warrantor in relation to this product. Philips and the Philips Shield Emblem are registered trademarks of Koninklijke Philips N.V. and are used under license.

Specifications are subject to change without notice.

Version: M10346PEIT