

User Manual

C43J890DK* C43J892DK* C49J890DK* C49J892DK*

The color and the appearance may differ depending on the product, and the specifications are subject to change without prior notice to improve the performance.

The contents of this manual are subject to change without notice to improve quality.

© Samsung Electronics

Samsung Electronics owns the copyright for this manual.

Use or reproduction of this manual in parts or entirety without the authorization of Samsung Electronics is prohibited.

Trademarks other than that of Samsung Electronics are owned by their respective owners.

An administration fee may be charged in the following situations:

- (a) An engineer is called out at your request, but it is found that the product has no defect (i.e., where the user manual has not been read).
- (b) You bring the unit to a repair centre, but it is found that the product has no defect (i.e., where the user manual has not been read).

You will be informed of the administration fee amount before a technician visits.

Table of contents

Before Using the Product

Securing the Installation Space	4
Precautions for storage	4
Safety Precautions	4
Cleaning	5
Electricity and Safety	5
Installation	6
Operation	7

Preparations

Parts	9
Control Panel	9
Direct Key guide	10
Function Key Guide	11
Changing Brightness, Contrast and Eye Saver Mode settings	13
Changing the Volume setting	13
Types of Ports	14
Upgrading the Software via USB	15
Adjusting the Product Tilt and Height	17
Anti-theft Lock	18
Installation	19
Attaching the Stand (Type one) (C43J890DK* / C43J892DK*)	19
Attaching the Stand (Type one) (C49J890DK* / C49J892DK*)	20
Attaching the Stand (Type two) (C43J890DK* / C43J892DK*)	21
Attaching the Stand (Type two) (C49J890DK* / C49J892DK*)	22

Removing the Stand (For Attaching the BRACKET WALL) (C43J890DK* / C43J892DK*)	23
Removing the Stand (For Attaching the BRACKET WALL) (C49J890DK* / C49J892DK*)	24
Attaching the BRACKET WALL (C43J890DK* / C43J892DK*)	25
Attaching the BRACKET WALL (C49J890DK* / C49J892DK*)	26

Connecting and Using a Source Device

Read below before installing the monitor.	27
Connecting and Using a Source Device	27
Connection Using the HDMI Cable	27
Connection Using the DP Cable	28
Connection Using the USB Type-C Cable	28
Connecting to Headphones	29
Connecting the Product to a Source Device as a USB Hub	29
Connecting a Source Device to the Product	29
Utilizing the Product as a USB HUB	30
Connecting the Power	31
Tidying Up the Connected Cables	32
Correct posture to use the product	33
Driver Installation	33
Setting Optimum Resolution	33

Picture

SAMSUNG MAGIC Bright	34
Brightness	35
Contrast	35
Sharpness	35
Color	35
SAMSUNG MAGIC Upscale	36
HDMI Black Level	36
Eye Saver Mode	36
Picture Size	37
Screen Adjustment	37
Calibration Report	37

Table of contents

PIP/PBP

PIP/PBP Mode	38
Size	39
Aspect Ratio	39
Position	40
Sound Source	40
Source	40
Switch USB	41
Picture Size	42
Contrast	43

OnScreen Display

Transparency	44
Position	44
Language	44
Display Time	44

System

USB Source Setup	45
DisplayPort Ver.	45
HDMI Mode	45
Smart ECO Saving	46
Off Timer Plus	46
PC/AV Mode	46
Source Detection	47
Key Repeat Time	47
Power LED On	47
Reset All	47
Information	47

Installing the Software

Easy Setting Box	48
Restrictions and Problems with the Installation	48
System Requirements	48

Troubleshooting Guide

Requirements Before Contacting Samsung Customer Service Center	49
Testing the Product	49
Checking the Resolution and Frequency	49
Check the following.	49
Q & A	52

Specifications

General	53
Standard Signal Mode Table	54

Appendix

Responsibility for the Pay Service (Cost to Customers)	57
Not a product defect	57
A Product damage caused by customer's fault	57
Others	57
Extended warranty	58

Chapter 01

Before Using the Product

Securing the Installation Space

Ensure some space around the product for ventilation. An internal temperature rise may cause fire and damage the product. Be sure to allow the amount of space as shown below or greater when installing the product.

- The exterior may differ depending on the product.

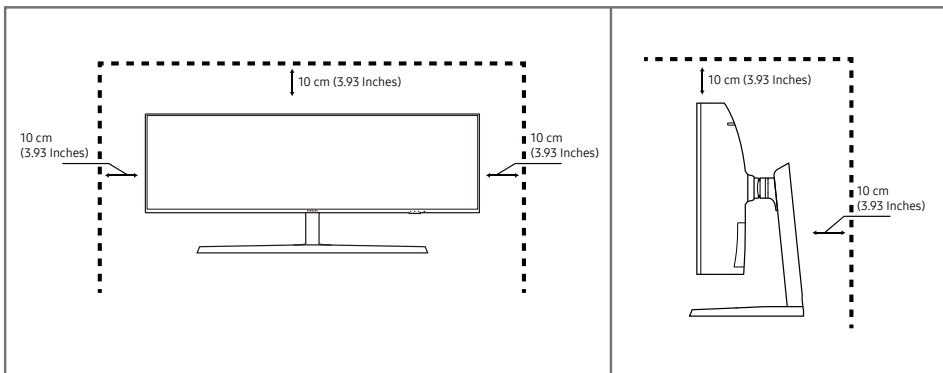

Precautions for storage

High-glossy models can develop white stains on the surface if an ultrasonic wave humidifier is used nearby.

- Contact your nearest Samsung Customer Service Center if you want to clean the inside of the product (Service fee will be charged.)

Do not press the monitor screen with hands or other objects. There is a risk of damaging the screen.

Safety Precautions

Warning

A serious or fatal injury may result if instructions are not followed.

Caution

Personal injury or damage to properties may result if instructions are not followed.

Cleaning

- Exercise care when cleaning as the panel and exterior of advanced LCDs are easily scratched.
 - Take the following steps when cleaning.
- 1** Power off the product and computer.
 - 2** Disconnect the power cord from the product.
 - Hold the power cable by the plug and do not touch the cable with wet hands. Otherwise, an electric shock may result.
 - 3** Wipe the monitor with a clean, soft and dry cloth.
 - Do not apply a cleaning agent that contains alcohol, solvent, or surfactant to the monitor.
 - Do not spray water or detergent directly on the product.
 - 4** Wet a soft and dry cloth in water and wring thoroughly to clean the exterior of the product.
 - 5** Connect the power cord to the product when cleaning is finished.
 - 6** Power on the product and computer.

Electricity and Safety

Warning

- Do not use a damaged power cord or plug, or a loose power socket.
- Do not use multiple products with a single power socket.
- Do not touch the power plug with wet hands.
- Insert the power plug all the way in so it is not loose.
- Connect the power plug to a grounded power socket (type 1 insulated devices only).
- Do not bend or pull the power cord with force. Be careful not to leave the power cord under a heavy object.
- Do not place the power cord or product near heat sources.
- Clean any dust around the pins of the power plug or the power socket with a dry cloth.

Caution

- Do not disconnect the power cord while the product is being used.
- Only use the power cord provided with your product by Samsung. Do not use the power cord with other products.
- Keep the power socket where the power cord is connected unobstructed.
 - The power cord must be disconnected to cut off power to the product when an issue occurs.
- Hold the plug when disconnecting the power cord from the power socket.

Installation

Warning

- DO NOT PLACE CANDLES, INSECT REPELLANTS OR CIGARETTES ON TOP OF THE PRODUCT. DO NOT INSTALL THE PRODUCT NEAR HEAT SOURCES.
- Do not install the product in poorly ventilated spaces such as a bookcase or closet.
- Install the product at least 10 cm away from the wall to allow ventilation.
- Keep the plastic packaging out of the reach of children.
 - Children may suffocate.
- Do not install the product on an unstable or vibrating surface (insecure shelf, sloped surface, etc.)
 - The product may fall and become damaged and/or cause an injury.
 - Using the product in an area with excess vibration may damage the product or cause a fire.
- Do not install the product in a vehicle or a place exposed to dust, moisture (water drips, etc.), oil, or smoke.
- Do not expose the product to direct sunlight, heat, or a hot object such as a stove.
 - The product lifespan may be reduced or a fire may result.
- Do not install the product within the reach of young children.
 - The product may fall and injure children.
- Edible oil (such as soybean oil) may damage or distort the product. Keep the product away from oil pollution. And do not install or use the product in the kitchen or near the kitchen stove.

Caution

- Do not drop the product while moving.
- Do not set down the product on its front.
- When installing the product on a cabinet or shelf, make sure that the bottom edge of the front of the product is not protruding.
 - The product may fall and become damaged and/or cause an injury.
 - Install the product only on cabinets or shelves of the right size.
- Set down the product gently.
 - Product failure or personal injury may result.
- Installing the product in an unusual place (a place exposed to a lot of fine dust, chemical substances, extreme temperatures or a significant presence of moisture, or a place where the product will operate continuously for an extended period of time) may seriously affect its performance.
 - Be sure to consult Samsung Customer Service Center if you want to install the product at such a place.

Operation

Warning

- There is a high voltage inside the product. Never disassemble, repair or modify the product yourself.
 - Contact Samsung Customer Service Center for repairs.
- To move the product, first disconnect all the cables from it, including the power cable.
- If the product generates abnormal sounds, a burning smell or smoke, disconnect the power cord immediately and contact Samsung Customer Service Center.
- Do not let children hang from the product or climb on top of it.
 - Children may become injured or seriously harmed.
- If the product is dropped or the outer case is damaged, turn off the power and disconnect the power cord. Then contact Samsung Customer Service Center.
 - Continued use can result in a fire or electric shock.
- Do not leave heavy objects or items that children like (toys, sweets, etc.) on top of the product.
 - The product or heavy objects may fall as children try to reach for the toys or sweets resulting in a serious injury.
- During a lightning or thunderstorm, power off the product and remove the power cable.
- Do not drop objects on the product or apply impact.
- Do not move the product by pulling the power cord or any cable.
- If a gas leakage is found, do not touch the product or power plug. Also, ventilate the area immediately.
- Do not lift or move the product by pulling the power cord or any cable.
- Do not use or keep combustible spray or an inflammable substance near the product.
- Ensure the vents are not blocked by tablecloths or curtains.
 - An increased internal temperature may cause a fire.
- Do not insert metallic objects (chopsticks, coins, hairpins, etc) or objects that burn easily (paper, matches, etc) into the product (via the vent or input/output ports, etc).
 - Be sure to power off the product and disconnect the power cord when water or other foreign substances have entered the product. Then contact Samsung Customer Service Center.
- Do not place objects containing liquid (vases, pots, bottles, etc) or metallic objects on top of the product.
 - Be sure to power off the product and disconnect the power cord when water or other foreign substances have entered the product. Then contact Samsung Customer Service Center.

Caution

- Leaving the screen fixed on a stationary image for an extended period of time may cause afterimage burn-in or defective pixels.
 - Activate power-saving mode or a moving-picture screen saver if you will not be using the product for an extended period of time.
- Disconnect the power cord from the power socket if you do not plan on using the product for an extended period of time (vacation, etc).
 - Dust accumulation combined with heat can cause a fire, electric shock or electric leakage.
- Use the product at the recommended resolution and frequency.
 - Your eyesight may deteriorate.
- Do not hold the product upside-down or move it by holding the stand.
 - The product may fall and become damaged or cause an injury.
- Looking at the screen too close for an extended period of time can deteriorate your eyesight.
- Do not use humidifiers or stoves around the product.
- Rest your eyes for more than 5 minutes or look at distance objects for every 1 hour of product use.
- Do not touch the screen when the product has been turned on for an extended period of time as it will become hot.
- Store small accessories out of the reach of children.
- Exercise caution when adjusting the product angle or stand height.
 - Your hand or finger may get stuck and injured.
 - Tilting the product at an excessive angle may cause the product to fall and an injury may result.
- Do not place heavy objects on the product.
 - Product failure or personal injury may result.
- When using headphones or earphones, do not turn the volume too high.
 - Having the sound too loud may damage your hearing.
- Do not drop the product while moving.
 - Product failure or personal injury may result.

Chapter 02

Preparations

Parts

Control Panel

The color and shape of parts may differ from what is shown. Specifications are subject to change without notice to improve quality.

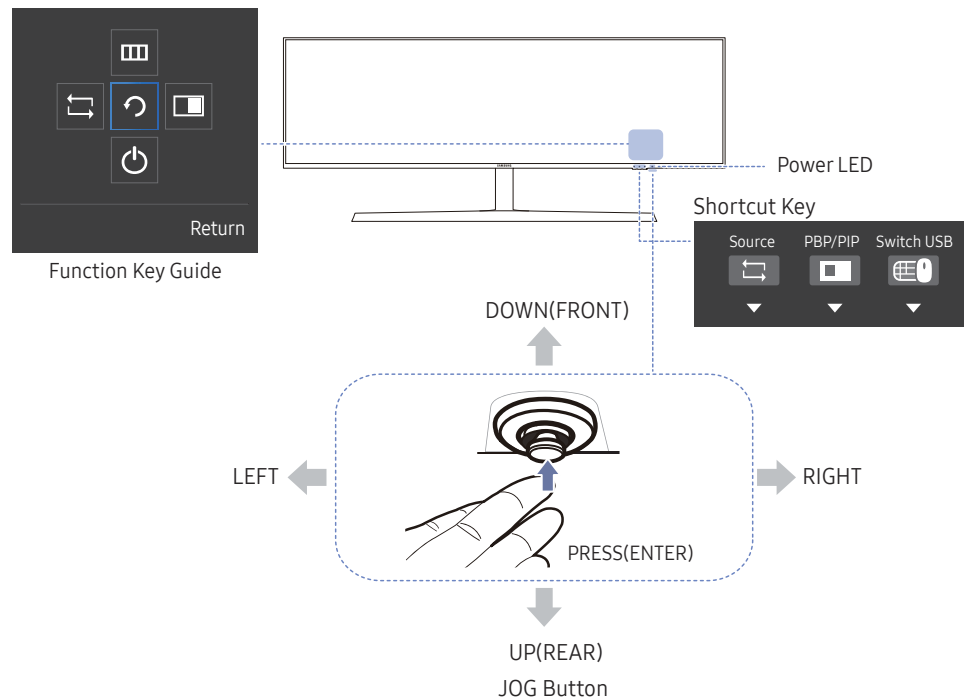

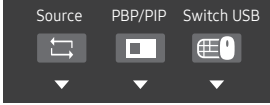
Icons	Description
	<ul style="list-style-type: none"> • Shortcut Key for Switching to a Source This button is a shortcut for switching to a different source. <ul style="list-style-type: none"> – When the source is switched, the USB connection will be changed at the same time according to the settings of USB Source Setup. – When PIP/PBP is On, only the source of the main screen can be switched. • Shortcut Key for PIP/PBP On-Off This button is a shortcut for the PIP/PBP On-Off function. <ul style="list-style-type: none"> – If there is no source for monitor, this button is disabled. The PIP/PBP On-Off item is also disabled and appears dimmed in OSD. • Shortcut Key for Switching USB This button is a shortcut for switching a USB device to a different input source. <ul style="list-style-type: none"> – The button is enabled only when PIP/PBP is On. If you press this button when PIP/PBP is Off, the message Only applied while PIP or PBP mode appears and nothing happens. Synchronously, The Switch USB item in OSD is also disabled and appears dimmed. – If you press this button when PIP/PBP is On but there is no input source, nothing happens.
Shortcut Key	
JOG Button	<p>Multi directional button that helps navigate.</p> <ul style="list-style-type: none"> – The JOG button is located at the bottom right side of the screen and has 5 directions of UP, DOWN, LEFT, RIGHT, and PRESS (ENTER).

Icons	Description
Power LED	<p>This LED is power status indicator and works as</p> <ul style="list-style-type: none"> • Power On (Power button): Off • Power saving mode: Blinking • Power Off (Power button): On <p>— The power Indicator operation can be swapped by changing in the menu. (System → Power LED On) Actual models because of functional variation maybe haven't this function.</p>
Function Key Guide	<p>Press the JOG button when the screen is turned on. The Function Key Guide will appear. To access the onscreen menu when the guide is displayed, press the corresponding direction button again.</p> <p>— Function Key Guide may vary depending on the function or product model. Please refer to the actual product.</p>

Direct Key guide





— The shortcut button screen (OSD menu) shown below is displayed only when the monitor screen is turned on, the computer resolution changes, or the input source changes.

— The function buttons page shows if **Eye Saver Mode** is enabled.

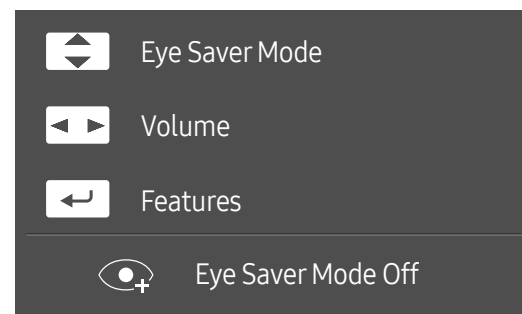
 : On

 : Off



-  /  : Adjust **Brightness, Contrast, Eye Saver Mode**.
-  : Adjust **Volume**.
-  : Display Function Key Guide.





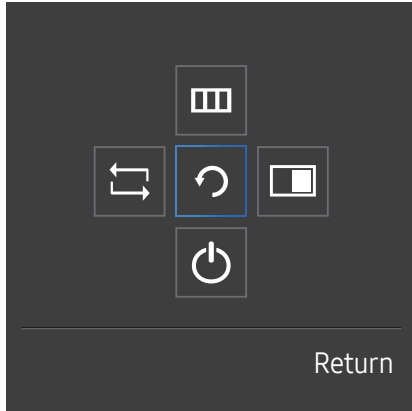



Function Key Guide

— To enter the main menu or to use other items, press the JOG button to display the Function Key Guide. You can exit by pressing the JOG button again.



UP/DOWN/LEFT/RIGHT: Move to the item you want. The description for each item will appear when the focus changes.

PRESS(ENTER): The selected item will be applied.

Icons	Description
	Selects  to change the input signal by moving the JOG button in the Function Key Guide screen. A message will appear on the top left corner of the screen if the input signal has been changed.
	Selects  by moving the JOG button in the function key guide screen. The OSD (On Screen Display) of your Monitor's feature appears. OSD control lock: Maintain the current settings, or lock the OSD control to prevent unintended changes to settings. Enable/Disable: To lock/unlock the OSD control, press the LEFT button for 10 seconds when the main menu displayed. — If the OSD control is locked, Brightness and Contrast can be adjusted. PIP/PBP is available. Eye Saver Mode is available. Information can be viewed.
	Selects  by moving the JOG button in the function key guide screen. Press the button when configuring settings for the PIP/PBP function is required.
	Selects  to turn the Monitor off by moving the JOG button in the function key guide screen.

— Actual models because of functional variation, Function key guide options will be different.

When the monitor displays nothing (i.e. Power saving mode or Non-signal mode), 2 direct keys for control source and power could be used as below.

JOG Button	Power saving/Non-signal mode
UP	Source Change
Down	
PRESS(ENTER) for 2 seconds	Power Off

When the monitor displays the Main menu the JOG Button could be used as below.

JOG Button	Action
UP/DOWN	Move the option
LEFT	Exit the Main menu. Close Sublist without saving value. Value decreases in the slider.
RIGHT	Move to next depth. Value increases in the slider.
PRESS(ENTER)	Move to next depth. Save the value and close Sublist.

Changing Brightness, Contrast and Eye Saver Mode settings

You can adjust **Brightness**, **Contrast** or **Eye Saver Mode** by moving the JOG button up or down, if no OSD menu is displayed.



— The displayed image may differ depending on the model.

Eye Saver Mode

Brightness

— This menu is not available when **Smart ECO Saving** is enabled.

— This menu is not available when **Eye Saver Mode** is enabled.

Contrast

— This menu is not available when **SAMSUNG MAGiC Bright** is set to **Cinema** mode.

— This menu is not available when **PIP/PBP Mode** is set to **On** and the **Size** is set to  (PBP Mode).

Changing the Volume setting

You can adjust **Volume** by moving the JOG button left or right, if no OSD menu is displayed.



— The displayed image may differ depending on the model.

— If the audio quality of a connected input device is poor, the Auto Mute function on the product may mute the sound or cause choppy audio when applying the headphones or speakers. Set the input volume for the input device to at least 20% and control the volume using the volume control (JOG button LEFT/RIGHT) on the product.

— What is Auto Mute?





The function mutes the audio to improve sound effect when there is sound noise or when the input signal is weak, usually due to a problem with the volume of an input device.



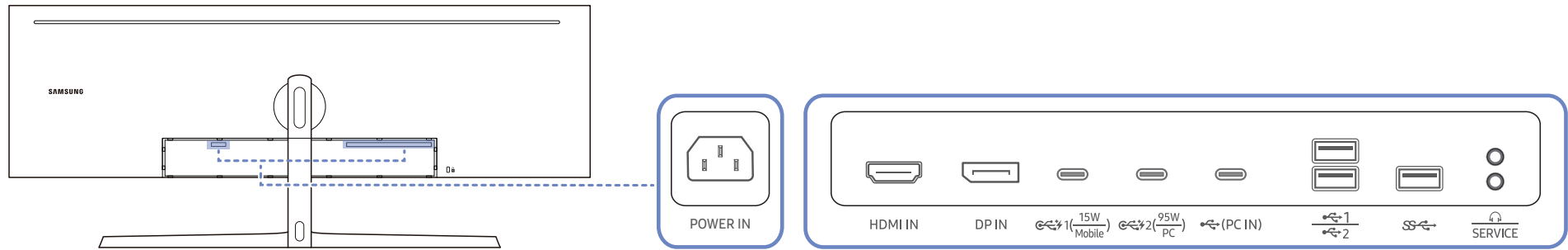









— To activate the **Mute** function, access the **Volume** control screen, then use the JOG button to move the focus down. To deactivate the **Mute** function, access the **Volume** control screen, then increase or decrease the **Volume**.

Types of Ports

— The color and shape of parts may differ from what is shown. Specifications are subject to change without notice to improve quality.



Port	Description
 POWER IN	Connect the power cord for your monitor to the POWER IN port on the back of the product.
 HDMI IN	Connects to a source device using an HDMI cable or HDMI-DVI cable.
 DP IN	Connects to a PC using a DP cable.
 15W Mobile, 95W PC	Connects to a source device using a USB Type-C cable. Compatible with a USB cable version 3.0 or lower.
 (PC IN)	Connects to a PC using a USB cable. — This port can only connect to a PC.

Port	Description
 1, 2	Connect to a USB device. These ports are enabled when a source device is connected to  (15W Mobile) or  (95W PC) using a USB Type-C to A cable or a USB Type-C cable. These ports are enabled when a source device is connected to  (PC IN) using a USB Type-C to A cable.
 SS	Connect to a USB device. This port is enabled when a source device is connected to  (15W Mobile) or  (95W PC) using a USB Type-C to A cable or a USB Type-C cable. This port is enabled when a source device is connected to  (PC IN) using a USB Type-C to A cable. And USB 3.0 is supported only when a source device is connected to  (15W Mobile) or  (95W PC) using a USB Type-C to A (3.0) cable.
 SERVICE	Connect to an audio output device such as headphones.
 SERVICE	Dedicated to service technicians.

Upgrading the Software via USB

- 1 Be sure to insert the USB disk into the USB port marked out with the blue box as shown in the figure below. You can upgrade the software via USB only if either the monitor screen operates normally or the check signal is displayed on the monitor screen.

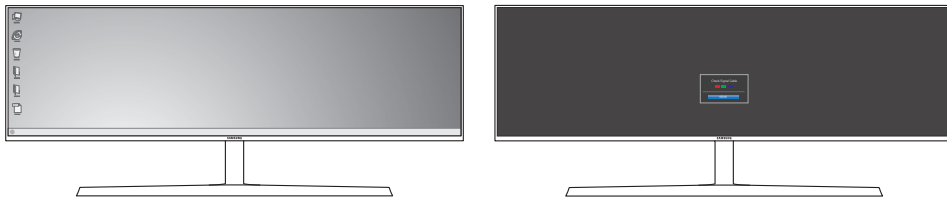
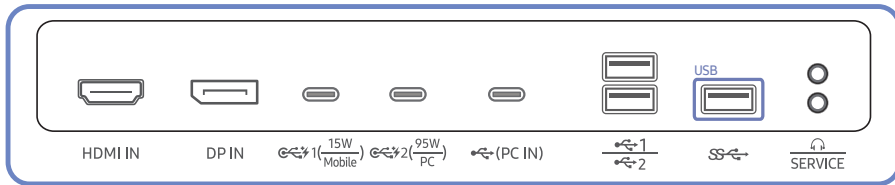

When the screen as shown in the following figure is displayed, press and hold the Down arrow key for 5 seconds.

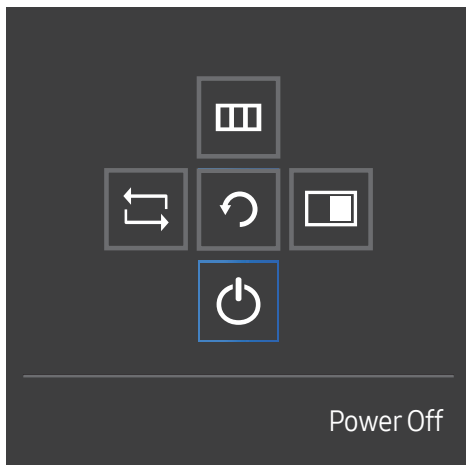

- 2 When the message as shown in the following figure is displayed on the monitor, select **Yes** to upgrade the software.

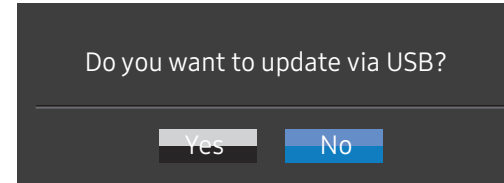

- 3 When the screen as shown in the following figure is displayed, select **Yes**.

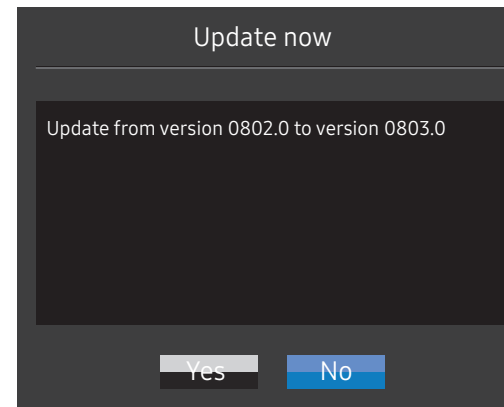

- 4 The software upgrading proceeds.

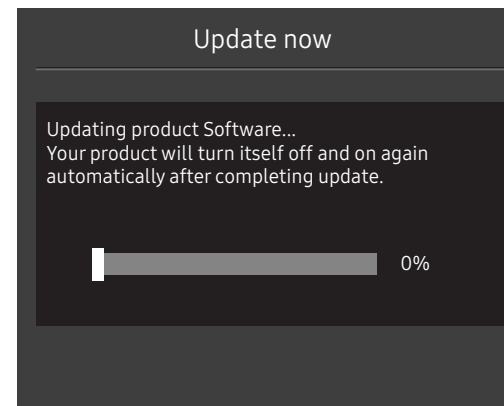

Note

- 1 Before upgrading through USB disk, you need to format the USB disk into the FAT32 format.
- 2 Make sure only the BIN file for upgrade is in the USB disk.
- 3 For the CJ89 model, make sure each upgrade file is in the BIN format and follow the naming rules of CJ89 (m-J89**CGAA-****.*[4-digit number].bin), wherein ** indicates the monitor size in inches, ****.* stands for the version number and the 4-digit number is the checksum. For example, "m-J8949CGAA-1000.0[9A80].bin" follows the naming rules of CJ89 49" model, and must be copied to the root directory.
- 4 If you want to keep the current version or degrade to a lower version, you may change file name to m-J89**CGAA-0000.0[4-digit number] and then perform the same operations.
- 5 If the **No valid update files found. Please check your USB device and try again.** message is displayed, this is probably due to the following reasons.

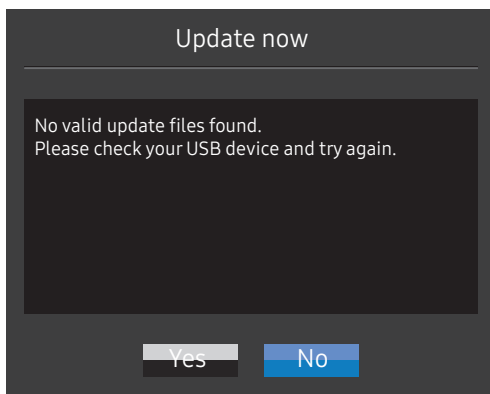

- No USB disk is inserted into the USB port marked out with the blue box.
 - The USB disk format is not supported.
 - The USB disk contains no valid upgrade files. (No upgrade files exist, or the file names are incorrect.)
- 6 Do not turn off the monitor. And prevent the upgrading from any interruption as far as possible. If an interruption happens, the monitor will return to the production version.
- Note that the production version may not be the same as the version before this upgrading if some other upgrading has been done earlier.

Adjusting the Product Tilt and Height

The color and shape of parts may differ from what is shown. Specifications are subject to change without notice to improve quality.

C43J890DK* / C43J892DK*: $-2.0^{\circ} (\pm 2.0^{\circ}) \sim 17.0^{\circ} (\pm 2.0^{\circ})$

C49J890DK* / C49J892DK*: $-2.0^{\circ} (\pm 2.0^{\circ}) \sim 15.0^{\circ} (\pm 2.0^{\circ})$

$-15.0^{\circ} (\pm 2.0^{\circ})$ to Left $\sim 15.0^{\circ} (\pm 2.0^{\circ})$ to Right

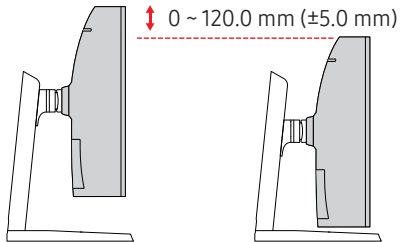
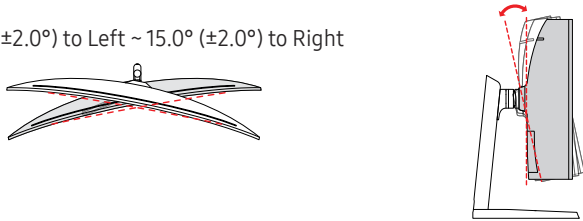

- The monitor tilt and height can be adjusted.
- When adjusting the tilt and height, hold both sides of the product and avoid using excessive force to prevent damage.
- When adjusting the stand height, you may hear a noise. This noise is generated because the ball inside the stand slides when the stand height is adjusted. It is a normal noise and not a product malfunction.

Caution

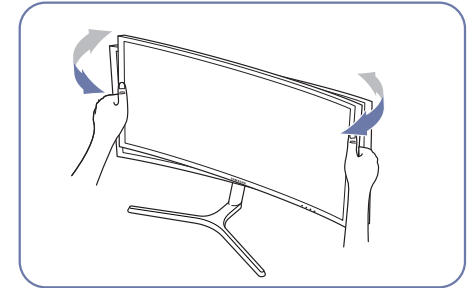
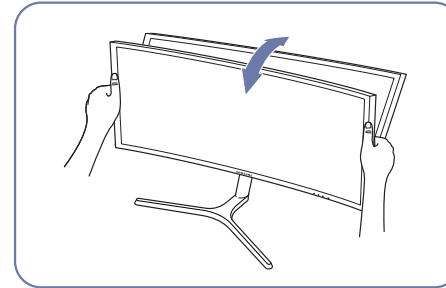

- Grasp the left and right sides of the monitor and adjust the tilt.

After adjusting the product tilt and height, if the screen is not level, take the following actions.

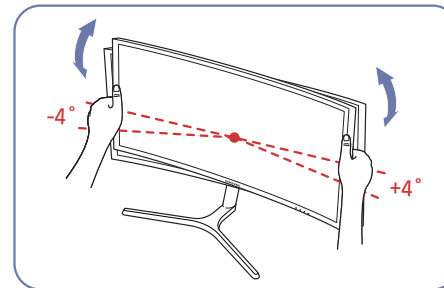

- Hold the bezel at both side edges and adjust the monitor angle until the screen becomes level. (Be careful not to directly hold the LCD display.)
- The monitor angle can be adjusted from -4° to $+4^{\circ}$.

Anti-theft Lock

- An anti-theft lock allows you to use the product securely even in public places.
- The locking device shape and locking method depend on the manufacturer. Refer to the user guide provided with your anti-theft locking device for details.

To lock an anti-theft locking device:

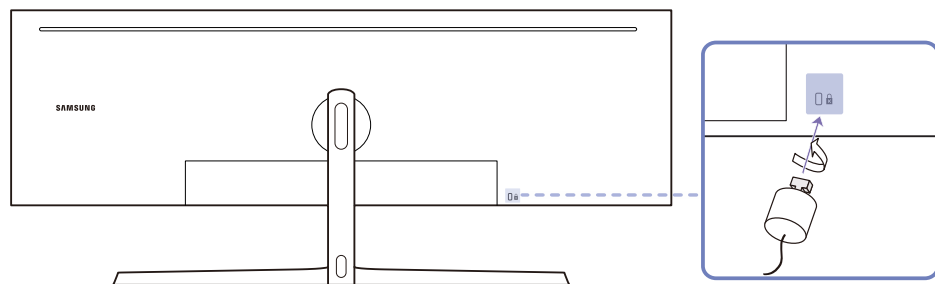

- 1 Fix the cable of your anti-theft locking device to a heavy object such as a desk.
- 2 Put one end of the cable through the loop on the other end.
- 3 Insert the locking device into the anti-theft lock slot at the back of the product.
- 4 Lock the locking device.
 - An anti-theft locking device can be purchased separately.
 - Refer to the user guide provided with your anti-theft locking device for details.
 - Anti-theft locking devices can be purchased at electronics retailers or online.

Installation

Attaching the Stand (Type one) (C43J890DK* / C43J892DK*)

— Before assembling the product, place the product down on a flat and stable surface so that the screen is facing downwards.

⚠ : The product is curved. Placing pressure on the product when on a flat surface may damage the product. When the product is on the ground facing up or down, do not put pressure on it.

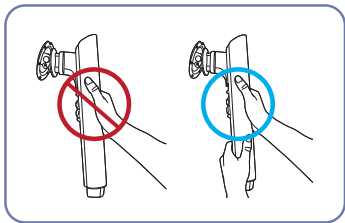

Caution
Hold the stand neck with both hands, not one hand, to prevent it from falling off and causing injury.

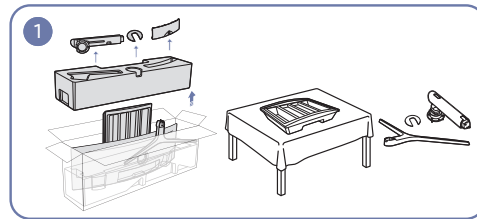

1 Remove the Cushion Top and Cushion Front, and then place the Cushion Front on the desk.

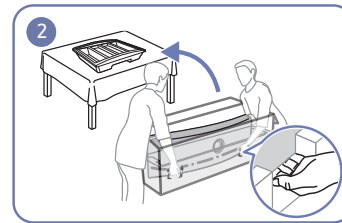

2 Pull the monitor out of the package (two people are required for this work), and then place the monitor on the Cushion Front.

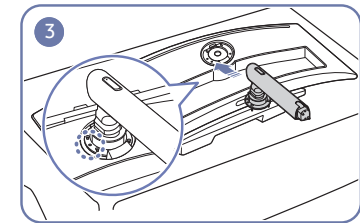

3 Place the stand neck on the monitor as shown in the figure.

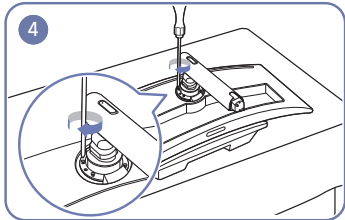

4 Fasten the screws at the top of the stand neck.

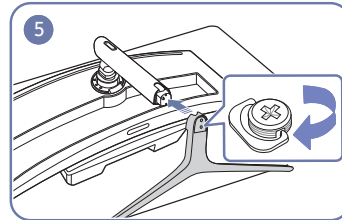

5 Insert the stand base into the stand neck in the direction as shown in the figure.

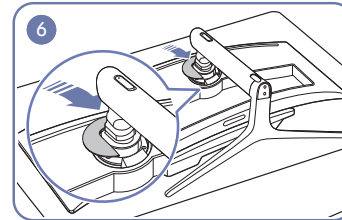

6 Assemble the COVER-CLEAN BACK STAND to the stand neck as shown in the figure.

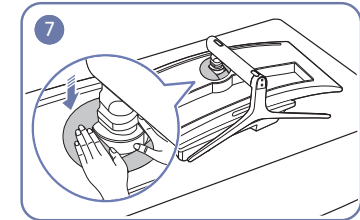

7 Push the COVER-CLEAN BACK STAND in the direction as shown in the figure.

Attaching the Stand (Type one) (C49J890DK* / C49J892DK*)

Before assembling the product, place the product down on a flat and stable surface so that the screen is facing downwards.

⚠ : The product is curved. Placing pressure on the product when on a flat surface may damage the product. When the product is on the ground facing up or down, do not put pressure on it.

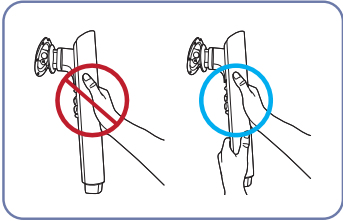

Caution

Hold the stand neck with both hands, not one hand, to prevent it from falling off and causing injury.

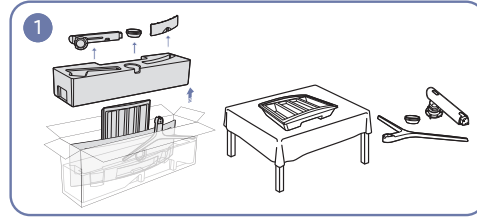

1 Remove the Cushion Top and Cushion Front, and then place the Cushion Front on the desk.

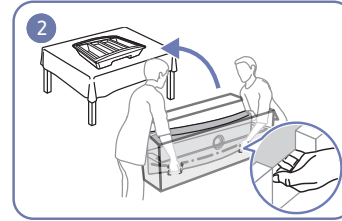

2 Pull the monitor out of the package (two people are required for this work), and then place the monitor on the Cushion Front.

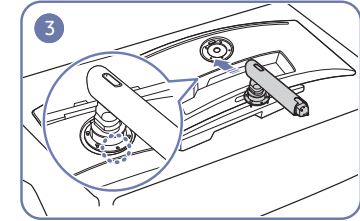

3 Place the stand neck on the monitor as shown in the figure.

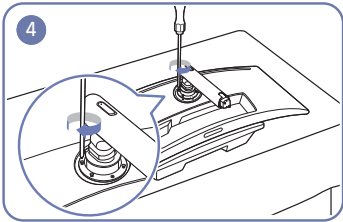

4 Fasten the screws at the top of the stand neck.

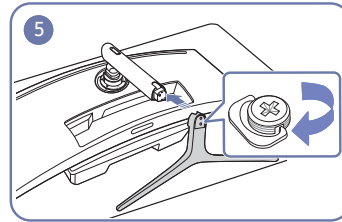

5 Insert the stand base into the stand neck in the direction as shown in the figure.

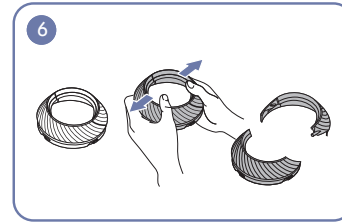

6 Disassemble the COVER-REAR TOP.

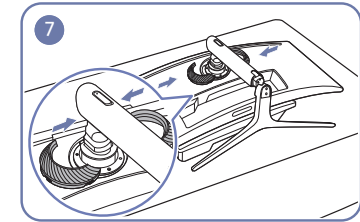

7 Assemble the COVER-REAR TOP to the stand neck as shown in the figure.

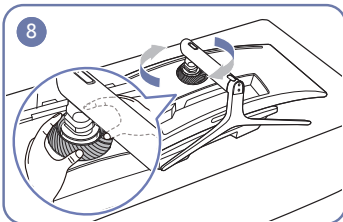

8 Rotate the COVER-REAR TOP clockwise.

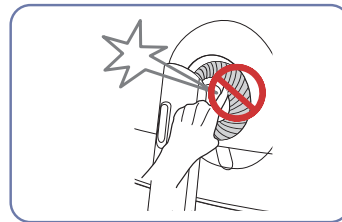

Attaching the Stand (Type two) (C43J890DK* / C43J892DK*)

— Before assembling the product, place the product down on a flat and stable surface so that the screen is facing downwards.

 : The product is curved. Placing pressure on the product when on a flat surface may damage the product. When the product is on the ground facing up or down, do not put pressure on it.

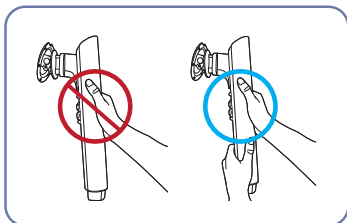

Caution
Hold the stand neck with both hands, not one hand, to prevent it from falling off and causing injury.

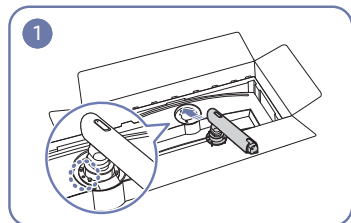

1 Place the stand neck on the monitor as shown in the figure.

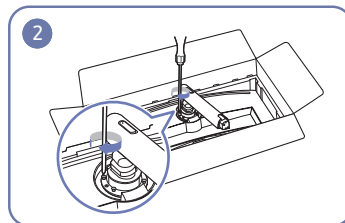

2 Fasten the screws at the top of the stand neck.

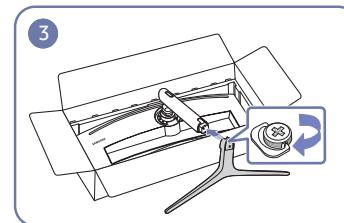

3 Insert the stand base into the stand neck in the direction as shown in the figure.

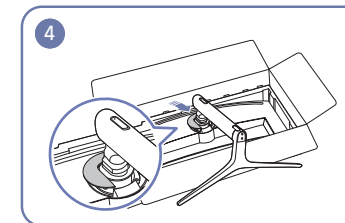

4 Assemble the COVER-CLEAN BACK STAND to the stand neck as shown in the figure.

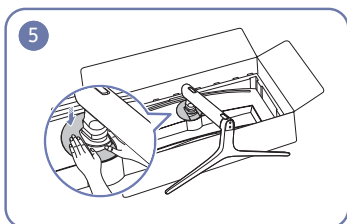

5 Push the COVER-CLEAN BACK STAND in the direction as shown in the figure.

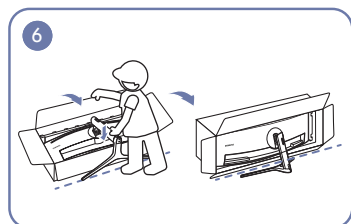

6 Stand up the monitor as shown in the figure.

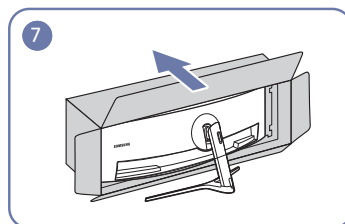

7 Remove the package.

Attaching the Stand (Type two) (C49J890DK* / C49J892DK*)

— Before assembling the product, place the product down on a flat and stable surface so that the screen is facing downwards.

 : The product is curved. Placing pressure on the product when on a flat surface may damage the product. When the product is on the ground facing up or down, do not put pressure on it.

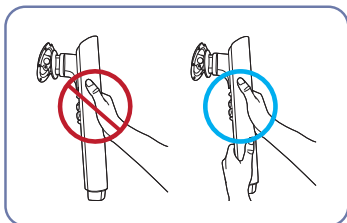

Caution
Hold the stand neck with both hands, not one hand, to prevent it from falling off and causing injury.

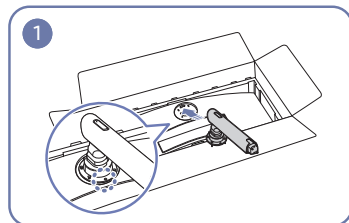

1 Place the stand neck on the monitor as shown in the figure.

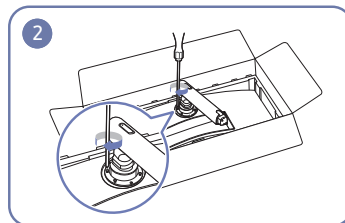

2 Fasten the screws at the top of the stand neck.

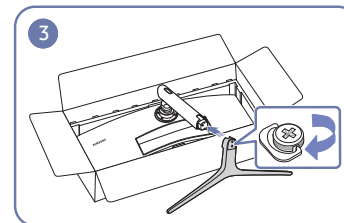

3 Insert the stand base into the stand neck in the direction as shown in the figure.

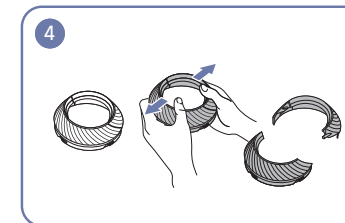

4 Disassemble the COVER-REAR TOP.

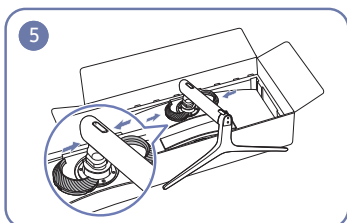

5 Assemble the COVER-REAR TOP to the stand neck as shown in the figure.

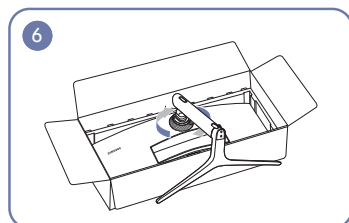

6 Rotate the COVER-REAR TOP clockwise.

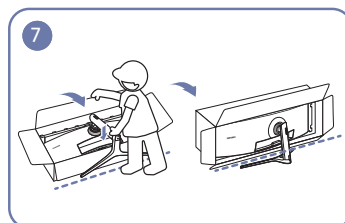

7 Stand up the monitor as shown in the figure.

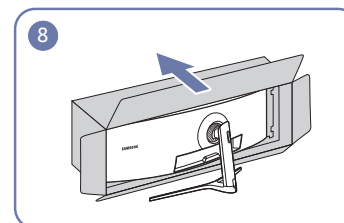

8 Remove the package.

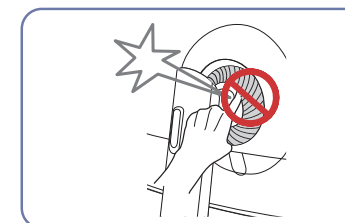

Removing the Stand (For Attaching the BRACKET WALL) (C43J890DK* / C43J892DK*)

— Before removing the stand from the monitor, place the monitor on a flat and stable surface with the screen facing down.

⚠ : The product is curved. Placing pressure on the product when on a flat surface may damage the product. When the product is on the ground facing up or down, do not put pressure on it.

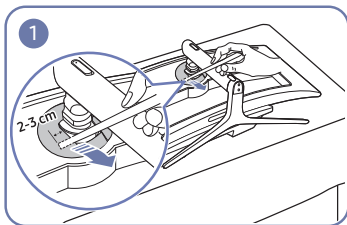

Disassemble the COVER-CLEAN BACK STAND with a thin stick, as shown in the figure.

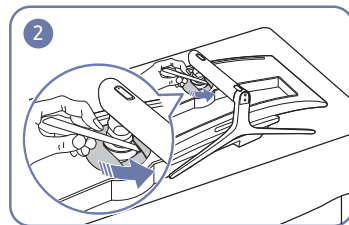

Disassemble the COVER-CLEAN BACK STAND.

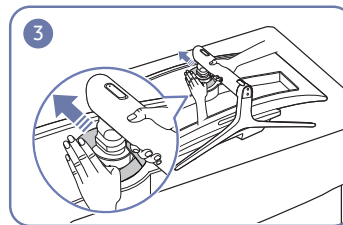

Remove the COVER-CLEAN BACK STAND.

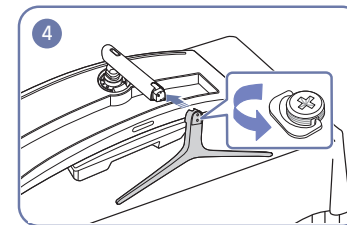

Remove the stand base from the stand neck.

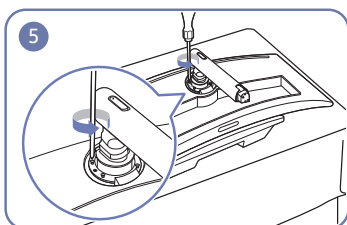

Unfasten the 4 screws at the top of the stand neck.

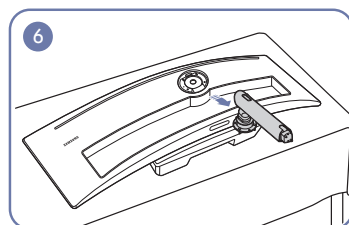

Lift and remove the stand.



Caution

Do not press down on the monitor. There is a risk of damaging the monitor.

Removing the Stand (For Attaching the BRACKET WALL) (C49J890DK* / C49J892DK*)

— Before removing the stand from the monitor, place the monitor on a flat and stable surface with the screen facing down.

⚠ : The product is curved. Placing pressure on the product when on a flat surface may damage the product. When the product is on the ground facing up or down, do not put pressure on it.

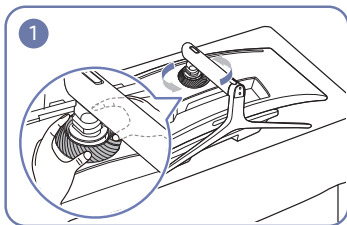

Rotate the COVER-REAR TOP counterclockwise.

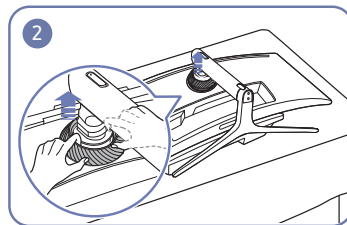

Lift the COVER-REAR TOP.

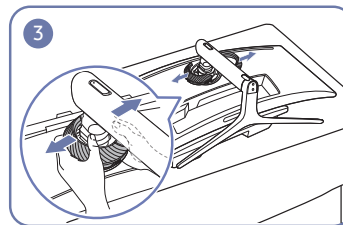

Disassemble the COVER-REAR TOP.

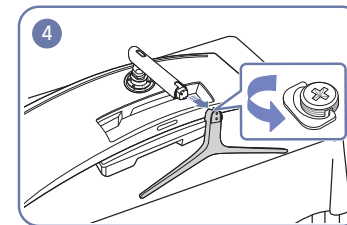

Remove the stand base from the stand neck.

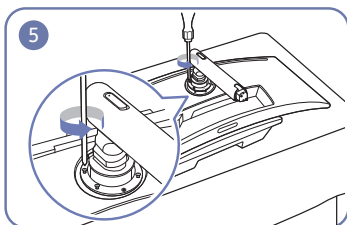

Unfasten the 4 screws at the top of the stand neck. Lift and remove the stand.

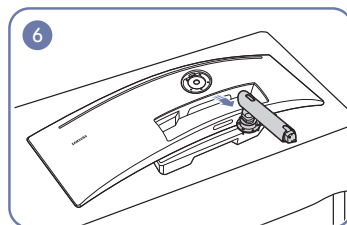

Caution

Do not press down on the monitor. There is a risk of damaging the monitor.

Attaching the BRACKET WALL (C43J890DK* / C43J892DK*)

— Power the product off and remove the power cable from the power socket.

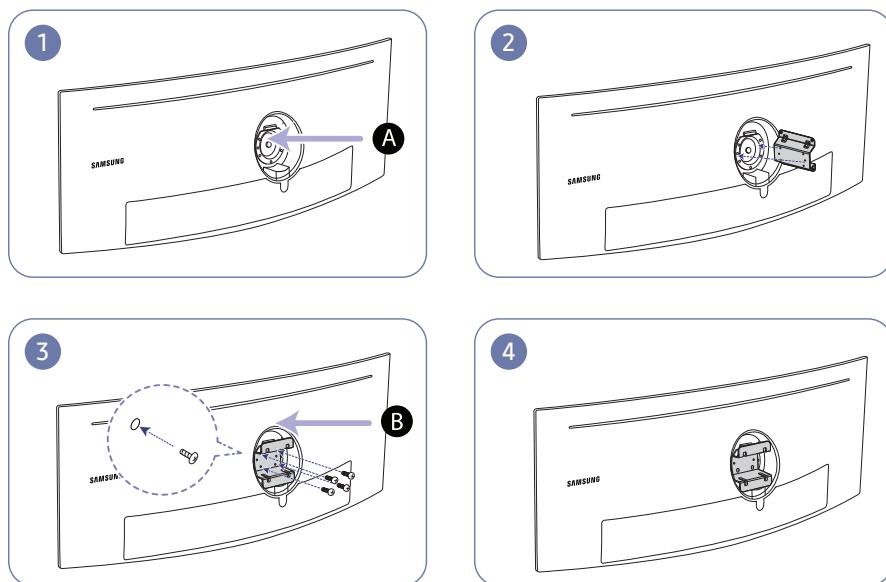

A Attach the BRACKET WALL here

B BRACKET WALL

Align **B** with **A** on the monitor, then tightly fasten with the screws removed from the stand ([P.23](#)).

• Notes

- Using a screw longer than the standard length can damage the internal components of the product.
- The length of screws required for a wall mount that does not comply with the VESA standards may vary depending on the specifications.
- Do not use screws that do not comply with the VESA standards. Do not attach the wall-mount kit or desktop stand using excessive force. The product may get damaged or fall and cause personal injury. Samsung shall not be held liable for any damage or injury caused by using improper screws or attaching the wall-mount kit or desktop stand using excessive force.
- Samsung shall not be held liable for any product damage or personal injury caused by using a wall-mount kit other than the one specified or from an attempt to install the wall-mount kit on your own.
- To mount the product on a wall, ensure you purchase a wall-mount kit that can be installed 10 cm or farther away from the wall.
- Be sure to use a wall-mount kit that complies with the national standards.
- To install the monitor using a wall mount, disconnect the stand base from the monitor.

Unit: mm (inches)

Model name	VESA screw hole specs (A * B) in millimeters	Standard Screw	Quantity
C43J890DK* / C43J892DK*	100.0 x 100.0 (3.9 x 3.9)	4.0 mm Φ , 0.7 pitch * 10.0 mm long	4 EA

— Do not install your Wall Mount Kit while your product is turned on. It may result in personal injury due to electric shock.

Attaching the BRACKET WALL (C49J890DK* / C49J892DK*)

— Power the product off and remove the power cable from the power socket.

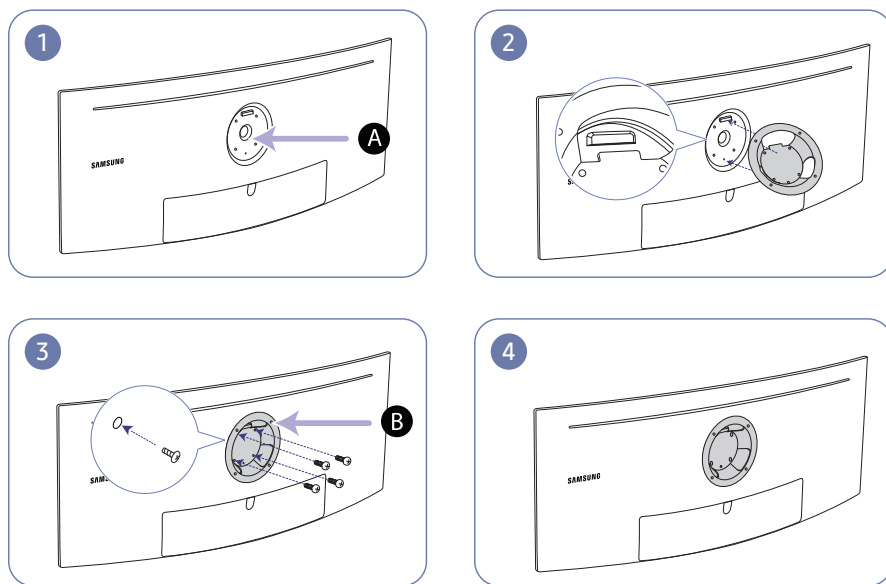

A Attach the BRACKET WALL here

B BRACKET WALL

Align **B** with **A** on the monitor, then tightly fasten with the screws removed from the stand ([P.24](#)).

• Notes

- Using a screw longer than the standard length can damage the internal components of the product.
- The length of screws required for a wall mount that does not comply with the VESA standards may vary depending on the specifications.
- Do not use screws that do not comply with the VESA standards. Do not attach the wall-mount kit or desktop stand using excessive force. The product may get damaged or fall and cause personal injury. Samsung shall not be held liable for any damage or injury caused by using improper screws or attaching the wall-mount kit or desktop stand using excessive force.
- Samsung shall not be held liable for any product damage or personal injury caused by using a wall-mount kit other than the one specified or from an attempt to install the wall-mount kit on your own.
- To mount the product on a wall, ensure you purchase a wall-mount kit that can be installed 10 cm or farther away from the wall.
- Be sure to use a wall-mount kit that complies with the national standards.
- To install the monitor using a wall mount, disconnect the stand base from the monitor.

Unit: mm (inches)

Model name	VESA screw hole specs (A * B) in millimeters	Standard Screw	Quantity
C49J890DK* / C49J892DK*	100.0 x 100.0 (3.9 x 3.9)	4.0 mm Φ , 0.7 pitch * 10.0 mm long	4 EA

— Do not install your Wall Mount Kit while your product is turned on. It may result in personal injury due to electric shock.

Chapter 03

Connecting and Using a Source Device

Read below before installing the monitor.

- 1 Check the shapes of both ends of the cables that came with the monitor, and check the shapes and positions of the matching ports on the monitor and external devices.
- 2 Before connecting signal cables, disconnect the power cables for the monitor and external devices from the power outlet to prevent device damage from a short circuit or overcurrent.
- 3 After connecting all signal cables, connect the power cables for the monitor and external devices to the power outlet.
- 4 Read the user manual to familiarize yourself with the monitor functions, precautions, and proper use, before using the installed monitor.

Connecting and Using a Source Device

Select a connection method suitable for your source device.

- Connecting parts may differ in different products.
- Provided ports may vary depending on the product.

Connection Using the HDMI Cable



Check to make sure that the power cables for the monitor and external devices, such as computers and set-top boxes, are not connected to the power outlet.



- When connecting an HDMI cable, use the cable that came with the components of the monitor. If you use an HDMI cable other than provided by Samsung, the image quality may be degraded. A Samsung branded cable is recommended.

Connection Using the DP Cable

- ⚠ Check to make sure that the power cables for the monitor and external devices, such as computers and set-top boxes, are not connected to the power outlet.

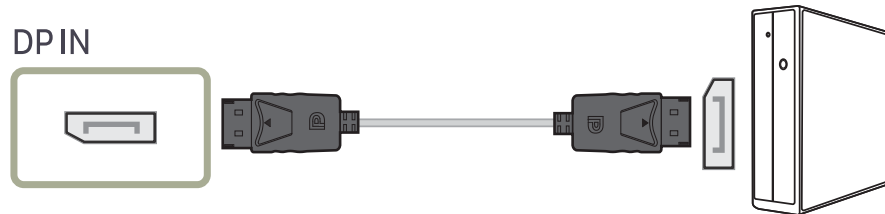

- When connecting a DP cable, use the cable that came with the components of the monitor. If you use a DP cable other than provided by Samsung, the image quality may be degraded. A Samsung branded cable is recommended.

Connection Using the USB Type-C Cable

- ⚠ Check to make sure that the power cables for the monitor and external devices, such as computers and set-top boxes, are not connected to the power outlet.

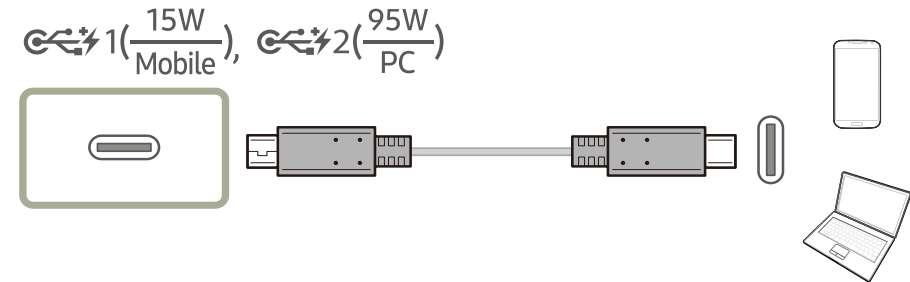

The USB Type-C port can support USB Power Delivery, Data, and DP video signal.

According to the USB Power Delivery 3.0 specification, the monitor can charge your notebook or mobile phone when you connect it to the monitor with a USB Type-C cable.

- For $1 \left(\frac{15W}{\text{Mobile}} \right)$, a maximum charging power of 15 W is supported. For $2 \left(\frac{95W}{\text{PC}} \right)$, a maximum charging power of 95 W is supported. So, $1 \left(\frac{15W}{\text{Mobile}} \right)$ is proper for a mobile phone and $2 \left(\frac{95W}{\text{PC}} \right)$ is proper for a notebook. Charging speed may vary depending on the notebook or mobile phone connected to the monitor.
- Because notebooks and mobile phones with a USB Type-C port released on the market are very various, we cannot guarantee that the monitor can charge all types of notebooks and mobile phones with a USB Type-C port.
- Make sure that the USB Type-C cable complies with the USB PD specification. Otherwise, your devices may be damaged. A Samsung branded cable is recommended.

Connecting to Headphones

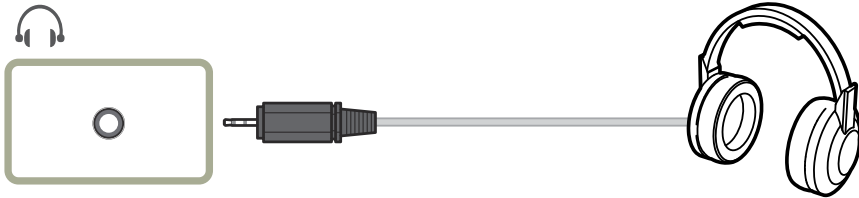





Connecting the Product to a Source Device as a USB Hub

Connecting a Source Device to the Product

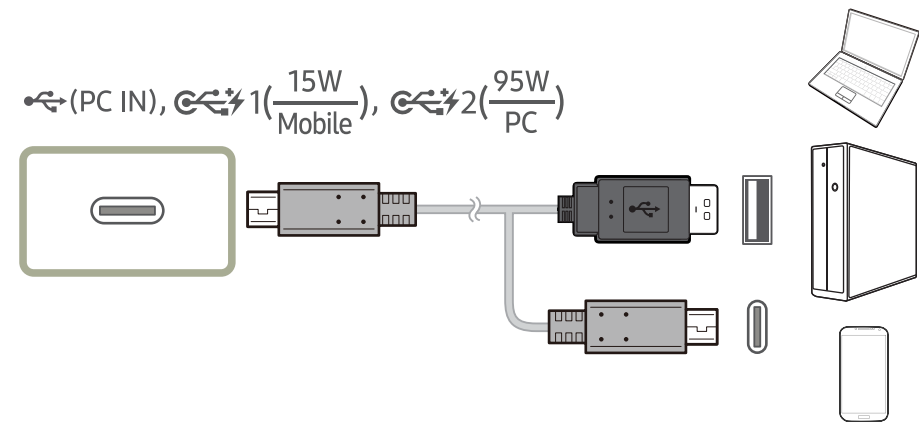
The product can function as a USB hub when it is connected to a source device via a USB Type-C cable or USB Type-C to A cable. Then you can connect USB devices to the product without having to directly connect them to the source device, and then you can control the USB devices from the product.

To use the product as a USB hub, connect a source device to the product using a USB Type-C cable or USB Type-C to A cable.



Connect the USB cable to  on the back of the product and to  or  on the source device.

Utilizing the Product as a USB HUB

Using the product as a hub, connect and use various source devices with the product at the same time.

A source device cannot connect to multiple devices at the same time if it has a limited number of available input/output ports. In this case, the hub feature of the product will improve your work efficiency by allowing you to connect multiple devices to the USB ports on the product at the same time without directly connecting them to a source device.

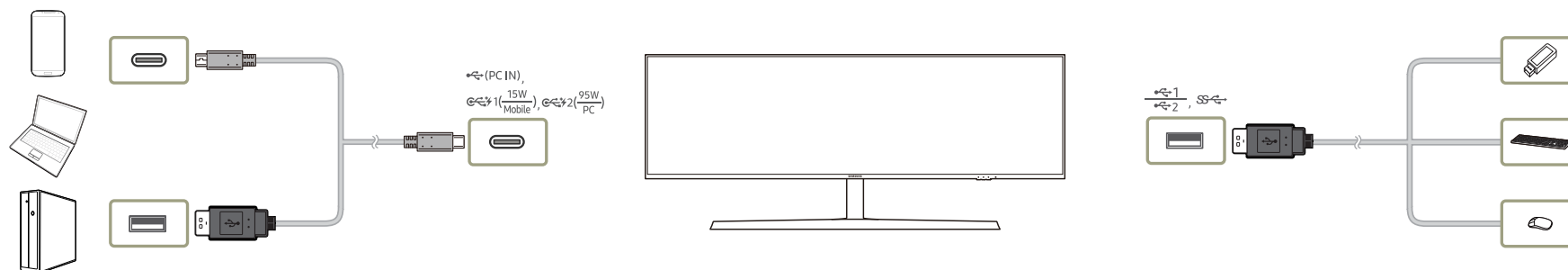

If multiple devices are connected to a source device, the many cables around the source device may look messy. Connecting the devices directly to the product will resolve such inconvenience.

Connect a mobile device such as an MP3 player or smartphone to the product connected to a source device. This allows you to control the device or charge the device battery from your PC.

- To detect and start a USB device faster, connect the device to the USB 3.0 port on the product. The read/write rate is affected by the USB device and your source device.
- The product does not support media play. If you need to play a file on your USB device, connect the product as a USB hub to your source device, and then play the file on your source device.
- For USB-related problems caused by OS, drive programs or software, please contact relevant suppliers.
- With the launch of various USB devices on the market, we cannot guarantee that our products are matched with all USB devices.
- For an external mass-storage HDD requiring external power supply, be sure to connect it to a power source.
- The battery can be charged in the power-saving mode, but it cannot be charged when the product is powered off.
- Charging your USB device is not possible if the power cable is disconnected from the power socket.
- The USB device needs to be purchased separately.

Connecting the Power

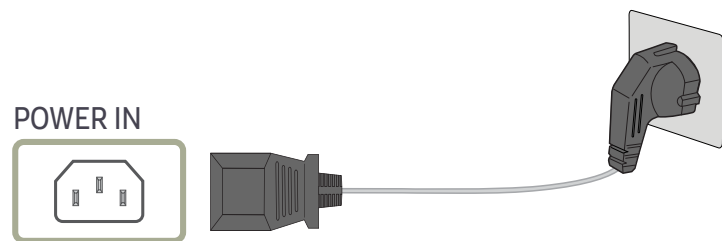

To use the product, connect the power cable to a power outlet and the **POWER IN** port on the product.

— The input voltage is switched automatically.

Tidying Up the Connected Cables

 : Headphones hanger

 : Downward

 : Upward

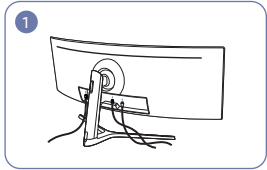

Connect the corresponding cables.

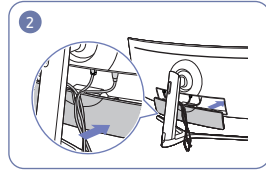

Arrange the cables against the bend tendency of the cables and pull the cables out of the COVER-REAR SUB grooves.

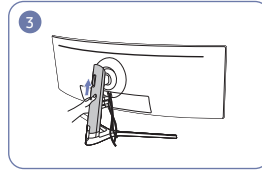

Push the COVER STAND BODY REAR in the direction as shown in the figure.

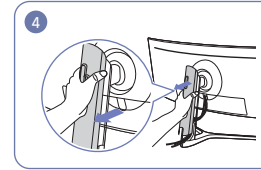

Remove the COVER STAND BODY REAR by pulling it in the direction as shown in the figure.

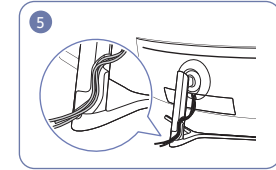

Place the corresponding cables into the stand-neck holder. Do not stretch the cable. Three cables in one holder is recommended.

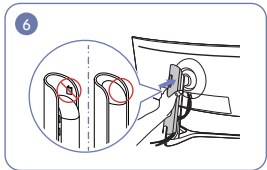

Attach the COVER STAND BODY REAR in the direction as shown in the figure with the buckles not being exposed.

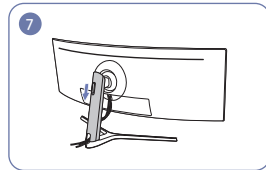

Move down the COVER STAND BODY REAR until it covers the stand neck completely.

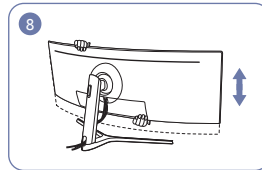

Adjust the set height, if required.

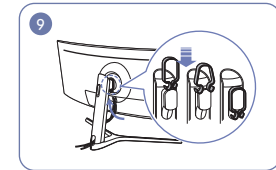
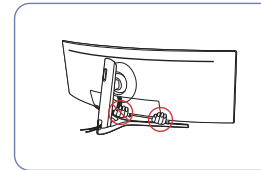

Hang the HOLDER-CABLE in the direction as shown in the figure.

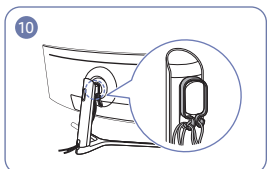

Arrange the cables against their bend tendency, and then pull them through the HOLDER-CABLE hangers. When the set height is changed, you need to arrange the cables and pull them through the HOLDER-CABLE hangers again.

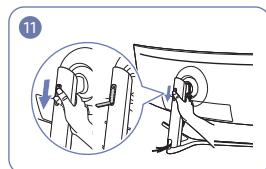

Open the Headset Hanger by pushing it down.

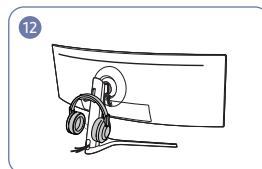

Hang the headset.

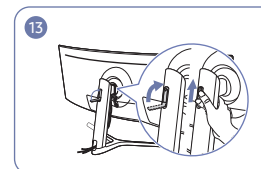

Rotate and then push up the Headset Hanger in the directions as shown in the figure.

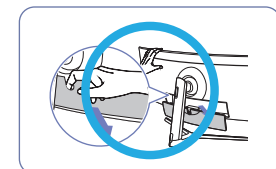

Caution
Open the COVER-REAR SUB in the direction as shown in the figure.

Correct posture to use the product



Use the product in the correct posture as follows:

- Straighten your back.
- Allow a distance of 45 to 50cm between your eye and the screen, and look slightly downward at the screen.
- Keep your eyes directly in front of the screen.
- Adjust the angle so light does not reflect on the screen.
- Keep your forearms perpendicular to your upper arms and level with the back of your hands.
- Keep your elbows at about a right angle.
- Adjust the height of the product so you can keep your knees bent at 90 degrees or more, your heels attached to the floor, and your arms lower than your heart.
- Do the Eye exercises or blink frequently, then eye fatigue will be relieved.

Driver Installation

- You can set the optimum resolution and frequency for this product by installing the corresponding drivers.
- To install the latest version of the product driver, download it from the Samsung Electronics website at <http://www.samsung.com>.

Setting Optimum Resolution

An information message about setting optimum resolution will appear if you power on the product for the first time after purchase.

Select a language on the product and change the resolution on your PC to the optimum setting.

- If the optimum resolution is not selected, the message will appear up to three times for a specified time even when the product is turned off and on again.
- The optimum resolution can also be selected in Control Panel on your PC.

Chapter 04

Picture

A detailed description of each function is provided. Refer to your product for details.

— The functions available may vary depending on the product model. The color and shape of parts may differ from what is shown. Specifications are subject to change without notice to improve quality.

SAMSUNG MAGIC Bright

This menu provides an optimum picture quality suitable for the environment where the product will be used.

- This menu is not available when **Smart ECO Saving** is enabled.
- This menu is not available when **Eye Saver Mode** is enabled.
- Not available when **PIP/PBP Mode** is set to **On**.

You can customize the brightness to suit your preferences.

In PC mode

- **Custom:** Customize the contrast and brightness as required.
- **Standard:** Obtain a picture quality suitable for editing documents or using Internet.
- **Cinema:** Obtain the brightness and sharpness of TVs suitable for enjoying video and DVD content.
- **High-brightness:** Maximize the screen brightness.

In AV mode

When the external input is connected through HDMI/DP/USB Type-C and **PC/AV Mode** is set to **AV**, **SAMSUNG MAGIC Bright** has four automatic picture settings (**Dynamic**, **Standard**, **Movie** and **Custom**) that are preset at the factory. You can activate either **Dynamic**, **Standard**, **Movie** or **Custom**. You can select **Custom** which automatically recalls your personalized picture settings.

- **Dynamic:** Select this mode to view a sharper image than in **Standard** mode.
- **Standard:** Select this mode when the surroundings are bright. This also provides a sharp image.
- **Movie:** Select this mode when the surroundings are dark. This will save power and reduce eye fatigue.
- **Custom:** Select this mode when you want to adjust the image according to your preferences.

Brightness

You can adjust the general brightness of the picture. (Range: 0~100)

A higher value will make the picture appear brighter.

- This menu is not available when **Smart ECO Saving** is enabled.
- This menu is not available when **Eye Saver Mode** is enabled.

Contrast

Adjust the contrast between the objects and background. (Range: 0~100)

A higher value will increase the contrast to make the object appear clearer.

- This menu is not available when **SAMSUNG MAGICBright** is set to **Cinema** mode.
- This menu is not available when **PIP/PBP Mode** is set to **On** and the **Size** is set to  (PBP Mode).

Sharpness

Make the outline of objects more clear or blurry. (Range: 0~100)

A higher value will make the outline of objects clearer.

- This menu is not available when **SAMSUNG MAGICBright** is set to **Cinema** mode.
- This menu is not available when **SAMSUNG MAGICUpscale** is in **Mode1** or **Mode2** mode.
- Not available when **PIP/PBP Mode** is set to **On**.

Color

Adjust the tint of the screen.

- This menu is not available when **SAMSUNG MAGICBright** is set to **Cinema** mode.
- This menu is not available when **Eye Saver Mode** is enabled.
- Not available when **PIP/PBP Mode** is set to **On**.
- **Red**: Adjust the red saturation level. Values closer to 100 mean greater intensity for the color.
- **Green**: Adjust the green saturation level. Values closer to 100 mean greater intensity for the color.
- **Blue**: Adjust the blue saturation level. Values closer to 100 mean greater intensity for the color.
- **Color Tone**: Select a color tone that best suits your viewing needs.
 - **Cool 2**: Set the color temperature to be cooler than **Cool 1**.
 - **Cool 1**: Set the color temperature to be cooler than **Normal** mode.
 - **Normal**: Display the standard color tone.
 - **Warm 1**: Set the color temperature to be warmer than **Normal** mode.
 - **Warm 2**: Set the color temperature to be warmer than **Warm 1**.
 - **Custom**: Customize the color tone.
- When the external input is connected through HDMI/DP/USB Type-C and **PC/AV Mode** is set to **AV**, **Color Tone** has four color temperature settings (**Cool**, **Normal**, **Warm** and **Custom**).
- **Gamma**: Adjust the middle level of luminance.
 - **Mode1** / **Mode2** / **Mode3**

SAMSUNG MAGIC Upscale

SAMSUNG MAGIC Upscale function can enhance the layers of the picture details and the vividness of the picture.

The function has more obvious effects on low-resolution pictures.

- This menu is not available when **SAMSUNG MAGIC Bright** is set to **Cinema** mode.
- Not available when **PIP/PBP Mode** is set to **On**.
- **Off / Mode1 / Mode2**
 - Comparing with **Mode1, Mode2** has a stronger effect.

HDMI Black Level

If a DVD player or set-top box is connected to the product via HDMI, image quality degradation (contrast/color degradation, black level, etc.) may occur, depending on the connected source device. In such case, **HDMI Black Level** can be used to adjust the image quality.

If this is the case, correct the degraded picture quality using **HDMI Black Level**.

- This function is only available in **HDMI** mode.
- Not available when **PIP/PBP Mode** is set to **On**.
- **Normal**: Select this mode when there is no contrast ratio degradation.
- **Low**: Select this mode to reduce the black level and increase the white level when there is a contrast ratio degradation.
- **HDMI Black Level** may not be compatible with some source devices.
- The **HDMI Black Level** feature is only activated at a certain **AV** resolution, such as 720P and 1080P.

Eye Saver Mode

Set to an optimum picture quality suitable for eye relaxation.

TÜV Rheinland “Low Blue Light Content” is a certification for products which meet requirements for lower blue light levels. When **Eye Saver Mode** is 'On', the blue light that wavelength is around 400nm will decrease, and it will provide an optimum picture quality suitable for eye relaxation. At the same time, the blue light level is lower than in the default settings, and it was tested by TÜV Rheinland and certified as it met the requirements of TÜV Rheinland “Low Blue Light Content” standards.

Picture Size

Change the picture size.

— This menu is not available when **PIP/PBP Mode** is set to **On** and the **Size** is set to  (PBP Mode).

In PC mode

- **Auto**: Display the picture according to the aspect ratio of the input source.
- **Wide**: Display the picture in full screen regardless of the aspect ratio of the input source.

In AV mode

- **4:3**: Display the picture with an aspect ratio of 4:3. Suitable for videos and standard broadcasts.
- **16:9**: Display the picture with an aspect ratio of 16:9.
- **Screen Fit**: Display the picture with the original aspect ratio without cutting off.

— The function may not be supported depending on the ports provided with the product.

— Changing the screen size is available when the following conditions are satisfied.

- A digital output device is connected using the HDMI/DP/USB Type-C cable.
- The input signal is 480p, 576p, 720p, or 1080p and monitor can display normally (Not every model can support all of these signals.).
- This can only be set when the external input is connected through HDMI/DP/USB Type-C and **PC/AV Mode** is set to **AV**.

Screen Adjustment

— This menu is only available when **Picture Size** is set to **Screen Fit** in **AV** Mode.

When a 480P or 576P or 720P or 1080P signal is input in **AV** mode and the monitor can display normally, select **Screen Fit** to adjust horizontal position in 0-6 levels.

Configuring H-Position & V-Position

H-Position: Move the screen to the left or right.

V-Position: Move the screen up or down.

Calibration Report

The data from this report are measured at the time of shipment.

- The measurements may vary according to the measuring equipment, measuring location, system environment (e.g. computer, graphic board, etc) and other variables.
- Input signal: **HDMI**
- Each measurement from this report is based on the **Custom** mode at the time of shipment.
- This report is not provided on the menu of some products, but in a separate hardcopy report instead.

Chapter 05

PIP/PBP

A detailed description of each function is provided. Refer to your product for details.

- The functions available may vary depending on the product model. The color and shape of parts may differ from what is shown. Specifications are subject to change without notice to improve quality.

PIP/PBP Mode

Enable or disable the **PIP/PBP Mode** function.

The PIP (Picture in Picture) function separates the screen into two parts. One source device is displayed on the main screen at the same time the another source device is displayed in inset windows.

The PBP (Picture by Picture) function separates the screen in half displaying output from two different source devices simultaneously on the left and right sides of the screen.

- **DisplayPort** and **USB Type-C1** cannot be selected as input sources at the same time.

- **PIP/PBP** mode is compatible with Windows 7, Windows 8, and Windows 10.
- The **PIP/PBP** function may not be available depending on the specifications of the graphics card used. If the screen is blank in **PIP/PBP** mode when the optimum resolution is selected, go to Control Panel → Display → Screen Resolution and click **Detect** on the PC. (Instructions are based on Windows 7.)
- The screen may flicker briefly or appear after a delay when you enable or disable the **PIP/PBP** function or when you change the screen size with the **PIP/PBP** function activated. This can typically arise when a PC and a monitor are connected to two or more input sources. It has nothing to do with the performance of a monitor.

The issue is mainly caused when the video signals are delayed in transmission to the monitor depending on the graphics card performance.

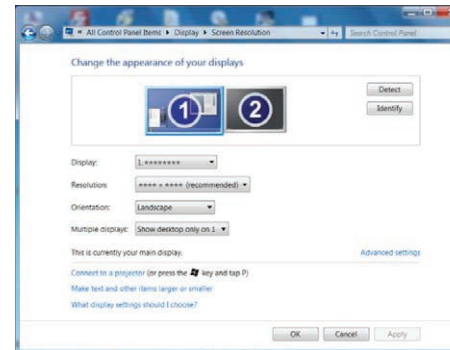



- To maximize the picture quality, it is recommended to use a graphics card that supports DFHD (3840 x 1080, 3840 x 1200) resolution.
- When using **PIP/PBP**, automatic switching to the optimum resolution and frequency is not available, due to conformance with the graphics card and Windows. Set **PIP/PBP Mode** to **Off**. Alternatively, restart the monitor, then set the resolution to the optimum setting using the Windows interface.



Size

Select the size and aspect ratio of the sub-screen.

C43J890DK* / C43J892DK*

- : Select the icon image if you want to use PBP mode where the optimum resolution for the left and right sides of the screen is 1920 x 1200 (width x height).
- : Select the icon image if you want to use PIP mode where the optimum resolution for the sub-screen is 720 x 480 (width x height).
- : Select the icon image if you want to use PIP mode where the optimum resolution of the sub-screen is 1280 x 720 (width x height).

C49J890DK* / C49J892DK*

- : Select the icon image if you want to use PBP mode where the optimum resolution for the left and right sides of the screen is 1920 x 1080 (width x height).
- : Select the icon image if you want to use PIP mode where the optimum resolution for the subscreen is 720 x 480 (width x height).
- : Select the icon image if you want to use PIP mode where the optimum resolution of the subscreen is 1280 x 720 (width x height).

Aspect Ratio

Select the image size for each screen.

C43J890DK* / C43J892DK*

- **16:10(16:10)**: Select this option if you want to use PBP mode where the optimum resolution for the left and right sides of the screen is 1920 x 1200 (width x height).
- **21:10(11:10)**: Select this option if you want to use PBP mode where the optimum resolution for the left side of the screen is 2520 x 1200 (width x height) and the optimum resolution for the right side of the screen is 1320 x 1200 (width x height).
- **11:10(21:10)**: Select this option if you want to use PBP mode where the optimum resolution for the left side of the screen is 1320 x 1200 (width x height) and the optimum resolution for the right side of the screen is 2520 x 1200 (width x height).

C49J890DK* / C49J892DK*

- **16:9(16:9)**: Select this option if you want to use PBP mode where the optimum resolution for the left and right sides of the screen is 1920 x 1080 (width x height).
- **21:9(11:9)**: Select this option if you want to use PBP mode where the optimum resolution for the left side of the screen is 2560 x 1080 (width x height) and the optimum resolution for the right side of the screen is 1280 x 1080 (width x height).
- **11:9(21:9)**: Select this option if you want to use PBP mode where the optimum resolution for the left side of the screen is 1280 x 1080 (width x height) and the optimum resolution for the right side of the screen is 2560 x 1080 (width x height).

Position

Select the position of the sub-screen from the available options.



— Not available when PBP is selected.

— The screen may flicker if the input signal is unstable.

Sound Source

Set which screen you want to hear the sound for.

PIP mode



PBP mode



Source

Select the source for each screen.

PIP Mode (available in PIP mode(Size /))

— The input source for the main screen changes.

— With the exception of the current input source, the other two input sources can be selected.

— The screen may flicker if the input signal is unstable.

— When the Function Key Guide appears, move the JOG button LEFT to select the  icon and then press the JOG button. The main screen will switch in the order **HDMI** → **DisplayPort** → **USB Type-C1** → **USB Type-C2**.

PBP Mode (available in PBP mode(Size))

— The input source for the main screen changes.

— The screen may flicker if the input signal is unstable.

— When the input signal of the left and right screens are the same, the operation cannot be performed.

— When the Function Key Guide appears, move the JOG button LEFT to select the  icon and then press the JOG button. The same PBP source setting menu appears.

Switch USB

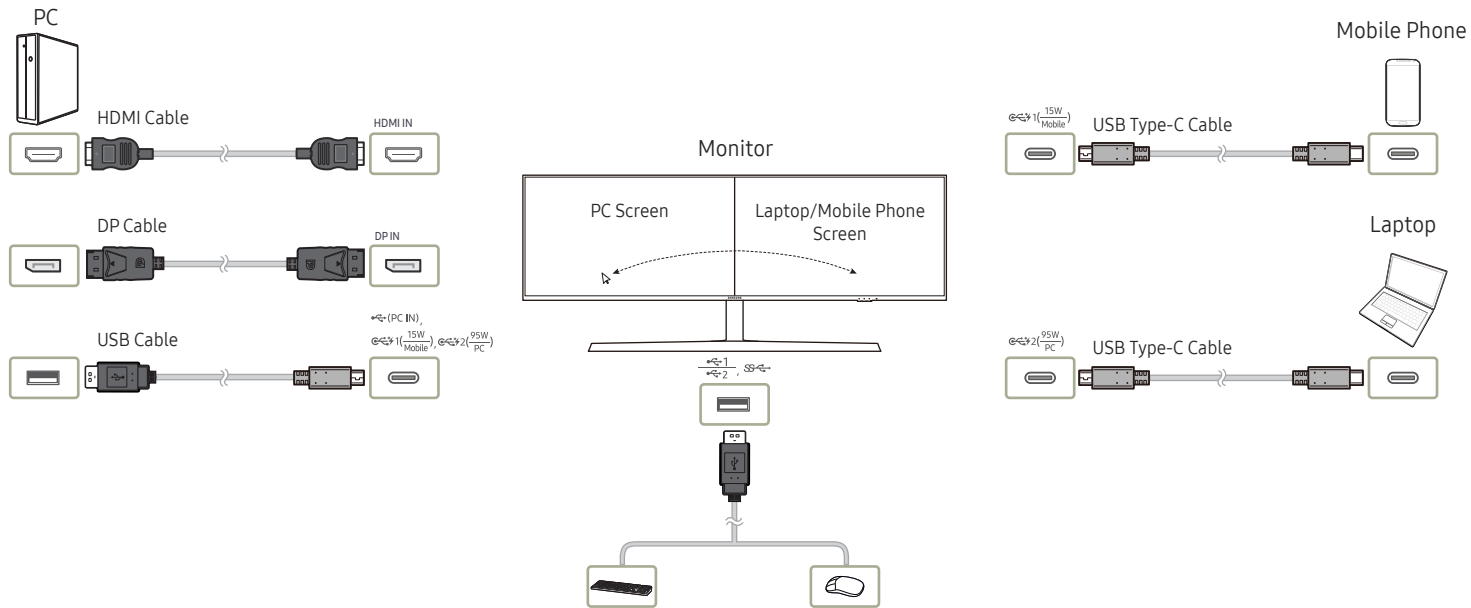

The KVM (keyboard, video, and mouse) switch enables users to use only a keyboard, a video monitor, and a mouse for controlling multiple input sources.

The function of the Samsung USB switch is as follows:

- When **PIP/PBP** of a Samsung monitor is on, USB devices (I/O device, USB storage device, etc.) connected to the monitor can be switched between different input sources using the USB switch.
 - Two different input sources must be connected to the monitor via source ports (HDMI, DP, USB-C#1, USB-C#2), and an upstream USB hub must be correctly connected to the monitor if required.
 - You must connect USB devices to the Samsung monitor, enable **PIP/PBP**, and then correctly set up USB hub assignment in the OSD.
- This function can be operated using the USB Switch Shortcut key or the USB Switch item in OSD.

– Each of USB-C#1 and USB-C#2 can be regarded as an upstream USB hub as well as an input source. Therefore, it is unnecessary to set up USB hub assignment for these two ports.

This option is for switching a USB device to a different input source.

– The option is disabled and appears dimmed if **PIP/PBP** is **Off**.

– When a USB device is switched to a source, information about the source including the USB hub port is displayed on the screen.

– The Keyboard and Mouse (KM) switch enables users to interact with and manage up to three input sources using a single mouse and keyboard.

– To prevent data damage or loss, make sure that, before performing **Switch USB**, no USB storage devices are being used by the input sources connected to the monitor.

Picture Size

PIP Mode (available in PIP mode (Size /))

Select the image size for sub-screen.

In PC mode

- **Auto:** Display the picture according to the aspect ratio of the each screen input source.
- **Wide:** Display the picture in full screen regardless of the aspect ratio of the each screen input source.

In AV mode

- **4:3:** Display the picture of the sub-screen with an aspect ratio of 4:3. Suitable for videos and standard broadcasts.
 - **16:9:** Display the picture with an aspect ratio of 16:9.
 - **Screen Fit:** Display the picture of the sub-screen with the original aspect ratio without cutting anything off.
- The function may not be supported depending on the ports provided with the product.
 - Changing the screen size is available when the following conditions are satisfied.
 - A digital output device is connected using the HDMI/DP/USB Type-C cable.
 - The input signal is 480p, 576p, 720p, or 1080p and monitor can display normally (Not every model can support all of these signals.).
 - This can only be set when the external input is connected through HDMI/DP/USB Type-C and **PC/AV Mode** is set to **AV**.

PBP Mode (available in PBP mode (Size))

Set the **Picture Size** for each of the divided screens.

In PC mode

- **Auto:** Display the picture according to the aspect ratio of the each screen input source.
- **Wide:** Display the picture in full screen regardless of the aspect ratio of the each screen input source.

In AV mode

- **4:3:** Display the picture of the sub-screen with an aspect ratio of 4:3. Suitable for videos and standard broadcasts.
 - **16:9:** Display the picture with an aspect ratio of 16:9.
 - **Screen Fit:** Display the picture of the sub-screen with the original aspect ratio without cutting anything off.
- The function may not be supported depending on the ports provided with the product.
 - Changing the screen size is available when the following conditions are satisfied.
 - A digital output device is connected using the HDMI/DP/USB Type-C cable.
 - The input signal is 480p, 576p, 720p, or 1080p and monitor can display normally (Not every model can support all of these signals.).
 - This can only be set when the external input is connected through HDMI/DP/USB Type-C and **PC/AV Mode** is set to **AV**.

Contrast

PIP Mode (available in PIP mode(Size  / ))

Adjust the contrast level for sub-screen.

PBP Mode (available in PBP mode(Size ))

Adjust the contrast level for each screen.

Chapter 06

OnScreen Display

A detailed description of each function is provided. Refer to your product for details.

— The functions available may vary depending on the product model. The color and shape of parts may differ from what is shown. Specifications are subject to change without notice to improve quality.

Transparency

Set the transparency for the menu windows.

Position

Adjust the menu position.

Language

Set the menu language.

- A change to the language setting will only be applied to the onscreen menu display.
- It will not be applied to other functions on your PC.

Display Time

Set the on-screen display (OSD) menu to automatically disappear if the menu is not used for a specified period of time.

Display Time can be used to specify the time after which you want the OSD menu to disappear.

Chapter 07

System

A detailed description of each function is provided. Refer to your product for details.

- The functions available may vary depending on the product model. The color and shape of parts may differ from what is shown. Specifications are subject to change without notice to improve quality.

USB Source Setup

This option is for assigning correct USB ports for HDMI and DP ports.

- You must assign a correct USB port for each input source to ensure that the USB Switch function works properly.
- USB-C#1 and USB-C#2 can be regarded as input sources and USB ports. Therefore, it is not necessary to set up them. The last USB port can only work as a USB port but not as an input source.
- USB-C#1 and DP cannot be displayed at the same time in **PIP/PBP Mode**.
- Factory reset does not change these USB port assignments.
- When you assign a USB port, it is not necessary to press the JOG button for confirmation. If you select an item, it is applied immediately.

DisplayPort Ver.

Select your DisplayPort version.

- Incorrect settings may cause the screen to go blank. If this occurs, check the device specifications.
- If the monitor is in **HDMI/DisplayPort/USB Type-C1/USB Type-C 2** mode and the screen says **Check Signal Cable** or power saving mode activates, press the JOG button to display the function-button screen and then select the  icon. You can select **1.1** or **1.2↑**.

HDMI Mode

Select the HDMI mode to use.

- The supportable device and resolution may differ depending on its version.
- When the version is changed, the screen may blink.
- If you set the **HDMI Mode** to **1.4**, some high resolutions may not be supported because of bandwidth limitation of the HDMI 1.4 protocol.
- When the setting is not appropriate, a blank screen may appear. In this case, check the specifications of the device.
- Set the **HDMI Mode** to **1.4** when there is no sound output from the DVD connected to our product.
- Not available when **PIP/PBP Mode** is set to **On**.

Smart ECO Saving

The **Smart ECO Saving** function reduces power consumption by controlling the electric current used by the monitor panel.

— This menu is not available when **Eye Saver Mode** is enabled.

- **Off:** Deactivate the **Smart ECO Saving** function.
- **On:** The power consumption will automatically be reduced by about 10 % over the current setting. (The reduction of power consumption depends on the customer screen brightness condition.)

Off Timer Plus

Configuring Off Timer

Off Timer: Turn on **Off Timer** mode.

Turn Off After: The off timer can be set within a range of 0 to 23 hours. The product will automatically power off after the specified number of hours.

— This option is only available when **Off Timer** is set to **On**.

— For products for the market in some regions, the **Off Timer** is set to automatically activate 4 hours after the product powers on. This is done in accordance with power supply regulations. If you do not want the timer to activate, go to **III** → **System** → **Off Timer Plus** and set **Off Timer** to **Off**.

Configuring Eco Timer

Eco Timer: Turn on **Eco Timer** mode.

Eco Off After: The **Eco Timer** can be set between 10 and 180 minutes. The product will automatically power off after the specified time has elapsed.

— This option is only available when **Eco Timer** is set to **On**.

PC/AV Mode

Set **PC/AV Mode** to **AV**. The picture size will be enlarged.

This option is useful when you view a movie.

- Set to **PC** when connected to a PC.
- Set to **AV** when connected to an AV device.

— This feature is only available on the widescreen models that include 16:9, 16:10 and 21:9.

— If the monitor is in **HDMI/DisplayPort/USB Type-C1/USB Type-C 2** mode and the screen says **Check Signal Cable** or power saving mode activates, press the JOG button to display the function-button screen and then select the **III** icon. You can select **PC** or **AV**.

Source Detection

Select either **Auto** or **Manual** as the method to recognize input signal.

Key Repeat Time

Control the response rate of a button when the button is pressed.

Acceleration, **1 sec**, or **2 sec** can be selected. If **No Repeat** is selected, a command responds only once when a button is pressed.

Power LED On

Configure the settings to enable or disable the power LED located at the lower part of the product.

- **Working**: The power LED is on when the product is turned on.
- **Stand-by**: The power LED is on when the product is turned off.

Reset All

Return all the settings for the product to the default factory settings.

Information

View the current input source, frequency, software version, and resolution.

Chapter 08

Installing the Software

Easy Setting Box



Easy Setting Box enables users to use the monitor by partitioning multiple sections.

To install the latest version of **Easy Setting Box**, download it from the Samsung Electronics website at <http://www.samsung.com>.

- The software may not work properly if you do not restart the computer after the installation.
- The Easy Setting Box icon may not appear depending on the computer system and the product specifications.
- If the shortcut icon does not appear, press the F5 key.

Restrictions and Problems with the Installation

The **Easy Setting Box** installation may be affected by the Graphics Card, Motherboard and the Networking Environment.

System Requirements

OS	Hardware
<ul style="list-style-type: none">• Windows 7 32Bit/64Bit• Windows 8 32Bit/64Bit• Windows 8.1 32Bit/64Bit• Windows 10 32Bit/64Bit	<ul style="list-style-type: none">• At least 32MB of memory• At least 60MB of free space on the hard disk drive

Chapter 09

Troubleshooting Guide

Requirements Before Contacting Samsung Customer Service Center

— Before calling Samsung Customer Service Center, test your product as follows. If the problem persists, contact Samsung Customer Service Center.

Testing the Product

Check if your product is operating normally by using the product test function.

If the screen is turned off and the power indicator blinks even though the product is properly connected to a PC, perform a self-diagnosis test.

- 1 Power off both the PC and product.
- 2 Disconnect the cables from the product.
- 3 Power on the product.
- 4 If the message **Check Signal Cable** appears, the product is working normally.

— If the screen remains blank, check the PC system, video controller and cable.

Checking the Resolution and Frequency

For a mode that exceeds the supported resolution (refer to [Standard Signal Mode Table](#)), the message **Not Optimum Mode** will appear for a short time.

— The displayed resolution may vary, depending on the computer system settings and cables.

Check the following.

Installation issue (PC mode)

The screen keeps switching on and off.

Check the cable connection between the product and PC, and ensure the connectors are locked.

Blank spaces are found on all four sides of the screen when an HDMI or HDMI-DVI cable is connected to the product and PC.

The blank spaces found on the screen have nothing to do with the product.

Blank spaces on the screen are caused by the PC or graphics card. To resolve the problem, adjust the screen size in the HDMI or DVI settings for the graphics card.

If the graphics card settings menu does not have an option to adjust the screen size, update the graphics card driver to the latest version.

(Please contact the graphics card or computer manufacturer for further details about how to adjust the screen settings.)

Screen issue

The power LED is off. The screen will not switch on.

Check that the power cable is connected properly.

The message **Check Signal Cable appears.**

Check that the cable is properly connected to the product.

Check that the device connected to the product is powered on.

Not Optimum Mode is displayed.

This message appears when the signal from the graphics card exceeds the maximum resolution or frequency for the product.

Change the maximum resolution and frequency to suit the product performance, referring to Standard Signal Mode Table (P.54).

The images on the screen look distorted.

Check the cable connection to the product.

The screen is not clear. The screen is blurry.

Remove any accessories (video extension cable, etc.) and try again.

Set the resolution and frequency to the recommended level.

The screen appears unstable and shaky. There are shadows or ghost images left on the screen.

Check that the resolution and frequency for the PC are within the range of resolution and frequency compatible with the product. Next, if required, change the settings, referring to Standard Signal Mode Table (P.54) in this manual and the **Information** menu on the product.

The screen is too bright. The screen is too dark.

Adjust **Brightness** and **Contrast**.

Screen color is inconsistent.

Change the **Color** settings.

The colors on the screen have a shadow and are distorted.

Change the **Color** settings.

White does not really look white.

Change the **Color** settings.

There is no image on the screen and the power LED blinks every 0.5 to 1 second.

The product is operating in power-saving mode.

Press any key on the keyboard or move the mouse to return to normal operating mode.

Text is blurry.

If using a Windows OS (e.g. Windows 7, Windows 8, Windows 8.1 or Windows 10): Go to **Control Panel** → **Fonts** → **Adjust ClearType text** and change **Turn on ClearType**.

Video playback is choppy.

Playback of high-definition large video files can be choppy. This may be because the video player is not optimized for the computer resource.

Try playing the file on another video player.

Sound issue

There is no sound.

Check the connection of the audio cable or adjust the volume.

Check the volume.

The volume is too low.

Adjust the volume.

If the volume is still low after turning it up to the maximum level, adjust the volume on your PC sound card or software program.

Video is available but there is no sound.

Sound cannot be heard if a HDMI-DVI cable is used to connect the input device.

Connect the device using an HDMI cable, DP cable or USB Type-C cable.

Source device issue

A beeping sound is heard when my PC is booting.

If a beeping sound is heard when your PC is booting, have your PC serviced.

— The LED lights on the frame of the product may be seen depending on the user's viewing angle. The light is harmless to people and has no bearing on product features and performance. The product is safe to use.

Universal Serial Bus (USB) issue

USB interface is not working (USB devices are not working).

Check that your monitor is turned on.

Reconnect the USB cable to your computer.

Reconnect the USB devices (USB connectors).

Turn off and then turn on the monitor again.

Reboot the computer.

Some USB devices like external portable HDDs require a higher electric current. Then connect the devices directly to the computer.

The USB Type-C port does not supply power (USB devices are not charged).

Check that the connected device is compliant with the USB-C specification.

Check that you use the USB Type-C cable shipped with your monitor.

The High Speed USB 3.0 interface is slow (The High Speed USB 3.0 devices work slowly or do not work at all).



Check that your computer is USB 3.0-compatible.

Some computers have USB 3.0, USB 2.0, and USB 1.1 ports. Ensure that the correct USB port is being used.

Reconnect the USB cable to your computer.

Reconnect the USB devices (USB connectors).

Reboot the computer.

USB 3.0 is supported only when a source device is connected to 1(^{15W}_{Mobile}) or 2(^{95W}_{PC}) using a USB Type-C to A (3.0) cable.

The wireless mouse is lagging or not working (responds slowly or does not respond).

Increase the distance between the USB device and the wireless USB receiver.

Position the wireless USB receiver as close as possible to the wireless mouse.

Use a USB-extender cable to position the wireless USB receiver as far away as possible from the USB port.

Q & A

— Refer to the user manual for your PC or graphics card for further instructions on adjustment.

How can I change the frequency?

Set the frequency on your graphics card.

- Windows 7: Go to **Control Panel** → **Appearance and Personalization** → **Display** → **Screen Resolution** → **Advanced settings** → **Monitor**, and adjust **Refresh rate** under **Monitor settings**.
 - Windows 8(Windows 8.1): Go to **Settings** → **Control Panel** → **Appearance and Personalization** → **Display** → **Screen Resolution** → **Advanced settings** → **Monitor**, and adjust **Refresh rate** under **Monitor settings**.
 - Windows 10: Go to **Settings** → **System** → **Display** → **Advanced display settings** → **Display adapter properties** → **Monitor**, and adjust **Screen refresh rate** under **Monitor settings**.
-

How can I change the resolution?

- Windows 7: Go to **Control Panel** → **Appearance and Personalization** → **Display** → **Adjust Resolution**, and adjust the resolution.
 - Windows 8(Windows 8.1): Go to **Settings** → **Control Panel** → **Appearance and Personalization** → **Display** → **Adjust Resolution**, and adjust the resolution.
 - Windows 10: Go to **Settings** → **System** → **Display** → **Advanced display settings**, and adjust the resolution.
-

How do I set power-saving mode?

- Windows 7: Set power-saving mode in **Control Panel** → **Appearance and Personalization** → **Personalize** → **Screen Saver Settings** → **Power options** or **BIOS SETUP** on the PC.
 - Windows 8(Windows 8.1): Set power-saving mode in **Settings** → **Control Panel** → **Appearance and Personalization** → **Personalize** → **Screen Saver Settings** → **Power options** or **BIOS SETUP** on the PC.
 - Windows 10: Set power-saving mode in **Settings** → **Personalization** → **Lock screen** → **Screen timeout settings** → **Power & sleep** or **BIOS SETUP** on the PC.
-

Chapter 10

Specifications

General

Model Name	C43J890DK* / C43J892DK*	C49J890DK* / C49J892DK*
Size	43 Class (43.4 Inches / 110.2 cm)	49 Class (48.9 Inches / 124.2 cm)
Display area	1052.3 mm (H) x 328.8 mm (V) 41.4 Inches (H) x 12.9 Inches (V)	1195.8 mm (H) x 336.3 mm (V) 47.1 Inches (H) x 13.2 Inches (V)
Pixel Pitch	0.274 mm (H) x 0.274 mm (V) 0.010787 Inches (H) x 0.010787 Inches (V)	0.3114 mm (H) x 0.3114 mm (V) 0.01226 Inches (H) x 0.01226 Inches (V)
Maximum Pixel Clock	600 MHz	660 MHz
Power Supply	AC100-240V~ 50/60Hz Refer to the label at the back of the product as the standard voltage can vary in different countries.	
Signal connectors	HDMI, DP, USB Type-C	
Environmental conditions	Operating	
	Temperature: 50 °F – 104 °F (10 °C – 40 °C) Humidity: 10 % – 80 %, non-condensing	
	Storage	
	Temperature: -4 °F – 113 °F (-20 °C – 45 °C) Humidity: 5 % – 95 %, non-condensing	

- Plug-and-Play
This monitor can be installed and used with any Plug-and-Play compatible systems. Two-way data exchange between the monitor and PC system optimizes the monitor settings. Monitor installation takes place automatically. However, you can customize the installation settings if desired.
- Panel Dots (Pixels)
Due to the nature of the manufacturing of this product, approximately 1 pixel per million (1ppm) may be brighter or darker on the LCD panel. This does not affect product performance.
- The above specifications are subject to change without notice to improve quality.
- This device is a Class B digital apparatus.
- For detailed device specifications, visit the Samsung Electronics website.

(USA only)

Dispose unwanted electronics through an approved recycler.
To find the nearest recycling location, go to our website:
www.samsung.com/recyclingdirect or call, (877) 278 - 0799

Standard Signal Mode Table

Model Name		C43J890DK* / C43J892DK*	C49J890DK* / C49J892DK*
Synchronization	Horizontal Frequency	30 – 160 kHz	30 – 170 kHz
	Vertical Frequency	50 – 120 Hz	50 – 144 Hz
Resolution	Optimum Resolution	3840 x 1200 @ 60 Hz	3840 x 1080 @ 60 Hz
	Maximum Resolution	3840 x 1200 @ 100 Hz (HDMI)	3840 x 1080 @ 120 Hz (HDMI)
		3840 x 1200 @ 120 Hz (DisplayPort)	3840 x 1080 @ 144 Hz (DisplayPort)
		3840 x 1200 @ 120 Hz (USB Type-C)	3840 x 1080 @ 144 Hz (USB Type-C)

If a signal that belongs to the following standard signal modes is transmitted from your PC, the screen will automatically be adjusted. If the signal transmitted from the PC does not belong to the standard signal modes, the screen may be blank even though the power LED turns on. In such a case, change the settings according to the following table by referring to the graphics card user manual.

C43J890DK* / C43J892DK*

Resolution	Horizontal Frequency (kHz)	Vertical Frequency (Hz)	Pixel Clock (MHz)	Sync Polarity (H/V)
CEA, 2560 x 1080	66.000	60.000	198.000	+/+
IBM, 720 x 400	31.469	70.087	28.322	-/+
MAC, 640 x 480	35.000	66.667	30.240	-/-
MAC, 832 x 624	49.726	74.551	57.284	-/-
MAC, 1152 x 870	68.681	75.062	100.000	-/-
VESA, 640 x 480	31.469	59.940	25.175	-/-
VESA, 640 x 480	37.861	72.809	31.500	-/-
VESA, 640 x 480	37.500	75.000	31.500	-/-
VESA, 800 x 600	35.156	56.250	36.000	+/+
VESA, 800 x 600	37.879	60.317	40.000	+/+
VESA, 800 x 600	48.077	72.188	50.000	+/+
VESA, 800 x 600	46.875	75.000	49.500	+/+
VESA, 1024 x 768	48.363	60.004	65.000	-/-
VESA, 1024 x 768	56.476	70.069	75.000	-/-
VESA, 1024 x 768	60.023	75.029	78.750	+/+

Resolution	Horizontal Frequency (kHz)	Vertical Frequency (Hz)	Pixel Clock (MHz)	Sync Polarity (H/V)
VESA, 1152 x 864	67.500	75.000	108.000	+/+
VESA, 1280 x 720	45.000	60.000	74.250	+/+
VESA, 1280 x 800	49.702	59.810	83.500	-/+
VESA, 1280 x 1024	63.981	60.020	108.000	+/+
VESA, 1280 x 1024	79.976	75.025	135.000	+/+
VESA, 1440 x 900	55.935	59.887	106.500	-/+
VESA, 1600 x 900	60.000	60.000	108.000	+/+
VESA, 1680 x 1050	65.290	59.954	146.250	-/+
VESA, 1920 x 1080	67.500	60.000	148.500	+/+
VESA, 3840 x 1200	74.063	59.970	296.250	+/-
VESA, 3840 x 1200	125.750	99.960	503.000	+/-
VESA, 3840 x 1200	152.520	120.000	597.880	+/-

C49J890DK* / C49J892DK*

Resolution	Horizontal Frequency (kHz)	Vertical Frequency (Hz)	Pixel Clock (MHz)	Sync Polarity (H/V)
CEA, 2560 x 1080	66.000	60.000	198.000	+/+
IBM, 720 x 400	31.469	70.087	28.322	-/+
MAC, 640 x 480	35.000	66.667	30.240	-/-
MAC, 832 x 624	49.726	74.551	57.284	-/-
MAC, 1152 x 870	68.681	75.062	100.000	-/-
VESA, 640 x 480	31.469	59.940	25.175	-/-
VESA, 640 x 480	37.861	72.809	31.500	-/-
VESA, 640 x 480	37.500	75.000	31.500	-/-
VESA, 800 x 600	35.156	56.250	36.000	+/+
VESA, 800 x 600	37.879	60.317	40.000	+/+
VESA, 800 x 600	48.077	72.188	50.000	+/+
VESA, 800 x 600	46.875	75.000	49.500	+/+
VESA, 1024 x 768	48.363	60.004	65.000	-/-
VESA, 1024 x 768	56.476	70.069	75.000	-/-
VESA, 1024 x 768	60.023	75.029	78.750	+/+
VESA, 1152 x 864	67.500	75.000	108.000	+/+

VESA, 1280 x 720	45.000	60.000	74.250	+/+
VESA, 1280 x 800	49.702	59.810	83.500	-/+
VESA, 1280 x 1024	63.981	60.020	108.000	+/+
VESA, 1280 x 1024	79.976	75.025	135.000	+/+
VESA, 1440 x 900	55.935	59.887	106.500	-/+
VESA, 1600 x 900	60.000	60.000	108.000	+/+
VESA, 1680 x 1050	65.290	59.954	146.250	-/+
VESA, 1920 x 1080	67.500	60.000	148.500	+/+
VESA, 3840 x 1080	66.625	59.968	266.500	+/-
VESA, 3840 x 1080	113.250	99.956	453.000	+/-
VESA, 3840 x 1080	137.250	119.974	549.000	+/-
VESA, 3840 x 1080	166.608	144.000	653.103	+/-

— Horizontal Frequency

The time required to scan a single line from the left to the right side of the screen is called a horizontal cycle. The reciprocal number of a horizontal cycle is called horizontal frequency. Horizontal frequency is measured in kHz.

— Vertical Frequency

Repeating the same picture dozens of times per second allows you to view natural pictures. The repeat frequency is called "vertical frequency" or "refresh rate" and is indicated in Hz.

— This product can be set to only one resolution for each screen size to obtain the optimum picture quality due to the nature of the panel. Using a resolution other than the specified resolution may degrade the picture quality. To avoid this, it is recommended that you select the optimum resolution specified for your product.

— Some resolutions listed in the table above may not be available depending on graphics card specifications.

Chapter 11

Appendix

Responsibility for the Pay Service (Cost to Customers)

— When the service is requested, in spite of in warranty, we may charge you for a visit from a service technician in the following cases.

Not a product defect

Cleaning of the product, Adjustment, Explanation, Re-installation and etc.

- If a service technician gives instructions on how to use product or simply adjusts options without disassembling product.
- If a defect is caused by external environmental factors (Internet, Antenna, Wired Signal, etc.)
- If a product is reinstalled or devices are connected additionally after installing the purchased product for the first time.
- If a product is reinstalled to move to a different spot or to move to a different house.
- If customer requests instructions on how to use because of another company's product.
- If customer requests instructions on how to use the network or another company's Program.
- If customer requests software installation and setup for the product.
- If a service technician removes/cleans dusts or foreign materials inside of the product.
- If customer requests an installation additionally after purchasing a product through home-shopping or online.

A Product damage caused by customer's fault

Product damage caused by customer's mishandling or wrong repair

If a product damage is caused by;

- External impact or drop.
- Use of supplies or separately sold product unspecified by Samsung.
- Repair from a person besides an engineer of outsourcing service company or partner of Samsung Electronics Co., Ltd.
- Remodeling or repairing the product by customer.
- Using it with incorrect voltage or non-authorized electrical connections.
- Not following the "cautions" in User Manual.

Others

- If product fails by natural disaster. (lightning, fire, earthquake, flood damage, etc)
- If consumable components are all used up. (Battery, Toner, Fluorescent lights, Head, Vibrator, Lamp, Filter, Ribbon, etc.)

— If customer requests a service in case the product has no defect, service fee may be charged. So please read User Manual first.

Extended warranty

You can buy an extended warranty within 90 days of purchasing the product.

The extended warranty will cover an additional period of 3 years, beyond the standard 3 year warranty.

Samsung guarantee that replacement parts will be available for 5 years after the end of production.

After 5 years, in the event that the Samsung's service center has run out of replacement parts and cannot repair the product, Samsung will replace your product at no additional charge. If the model you purchased is no longer available, Samsung replace it with the current equivalent model.