

ASUS[®]

**BE209 / BE229 / BE239 /
BE249 / BE24A / BE24C /
BE27A Series LCD
Monitor**

User Guide

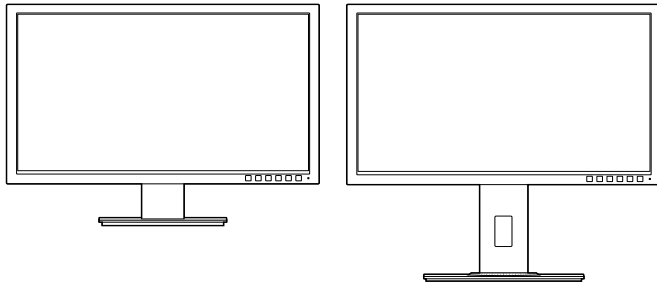

HDMI[™]
HIGH DEFINITION MULTIMEDIA INTERFACE

First Edition

June 2015

Copyright © 2015 ASUSTeK COMPUTER INC. All Rights Reserved.

No part of this manual, including the products and software described in it, may be reproduced, transmitted, transcribed, stored in a retrieval system, or translated into any language in any form or by any means, except documentation kept by the purchaser for backup purposes, without the express written permission of ASUSTeK COMPUTER INC. ("ASUS").

Product warranty or service will not be extended if: (1) the product is repaired, modified or altered, unless such repair, modification or alteration is authorized in writing by ASUS; or (2) the serial number of the product is defaced or missing.

ASUS PROVIDES THIS MANUAL "AS IS" WITHOUT WARRANTY OF ANY KIND, EITHER EXPRESS OR IMPLIED, INCLUDING BUT NOT LIMITED TO THE IMPLIED WARRANTIES OR CONDITIONS OF MERCHANTABILITY OR FITNESS FOR A PARTICULAR PURPOSE. IN NO EVENT SHALL ASUS, ITS DIRECTORS, OFFICERS, EMPLOYEES OR AGENTS BE LIABLE FOR ANY INDIRECT, SPECIAL, INCIDENTAL, OR CONSEQUENTIAL DAMAGES (INCLUDING DAMAGES FOR LOSS OF PROFITS, LOSS OF BUSINESS, LOSS OF USE OR DATA, INTERRUPTION OF BUSINESS AND THE LIKE), EVEN IF ASUS HAS BEEN ADVISED OF THE POSSIBILITY OF SUCH DAMAGES ARISING FROM ANY DEFECT OR ERROR IN THIS MANUAL OR PRODUCT.

SPECIFICATIONS AND INFORMATION CONTAINED IN THIS MANUAL ARE FURNISHED FOR INFORMATIONAL USE ONLY, AND ARE SUBJECT TO CHANGE AT ANY TIME WITHOUT NOTICE, AND SHOULD NOT BE CONSTRUED AS A COMMITMENT BY ASUS. ASUS ASSUMES NO RESPONSIBILITY OR LIABILITY FOR ANY ERRORS OR INACCURACIES THAT MAY APPEAR IN THIS MANUAL, INCLUDING THE PRODUCTS AND SOFTWARE DESCRIBED IN IT.

Products and corporate names appearing in this manual may or may not be registered trademarks or copyrights of their respective companies, and are used only for identification or explanation and to the owners' benefit, without intent to infringe.

Contents

Contents	iii
Notices	iv
Safety information	vi
Care & Cleaning	vii
Takeback Services	viii
Chapter 1: Product introduction	
1.1 Welcome!	1-1
1.2 Package contents	1-1
1.3 Monitor introduction	1-2
1.3.1 Front view	1-2
1.3.2 Back view	1-4
1.3.3 QuickFit Function	1-5
Chapter 2: Setup	
2.1 Assembling the monitor arm/base	2-1
2.2 Detaching the arm/base (for VESA wall mount)	2-1
2.3 Attaching/Removing the MiniPC Kit (BE209/BE229/BE239/BE249/ BE24A/BE24C/BE27A height adjustment base)	2-3
2.4 Adjusting the monitor	2-4
2.5 Connecting the cables	2-5
2.6 Turning on the monitor	2-6
Chapter 3: General instructions	
3.1 OSD (On-Screen Display) menu	3-1
3.1.1 How to reconfigure	3-1
3.1.2 OSD function introduction	3-2
3.2 Specifications summary	3-10
3.3 Troubleshooting (FAQ)	3-19
3.4 Supported operating modes	3-20

Notices

Federal Communications Commission Statement

This device complies with Part 15 of the FCC Rules. Operation is subject to the following two conditions:

- This device may not cause harmful interference, and
- This device must accept any interference received including interference that may cause undesired operation.

This equipment has been tested and found to comply with the limits for a Class B digital device, pursuant to Part 15 of the FCC Rules. These limits are designed to provide reasonable protection against harmful interference in a residential installation. This equipment generates, uses and can radiate radio frequency energy and, if not installed and used in accordance with manufacturer's instructions, may cause harmful interference to radio communications. However, there is no guarantee that interference will not occur in a particular installation. If this equipment does cause harmful interference to radio or television reception, which can be determined by turning the equipment off and on, the user is encouraged to try to correct the interference by one or more of the following measures:

- Reorient or relocate the receiving antenna.
- Increase the separation between the equipment and receiver.
- Connect the equipment to an outlet on a circuit different from that to which the receiver is connected.
- Consult the dealer or an experienced radio/TV technician for help.



The use of shielded cables for connection of the monitor to the graphics card is required to assure compliance with FCC regulations. Changes or modifications to this unit not expressly approved by the party responsible for compliance could void the user's authority to operate this equipment.



As an Energy Star® Partner, our company has determined that this product meets the Energy Star® guidelines for energy efficiency.

Canadian Department of Communications Statement

This digital apparatus does not exceed the Class B limits for radio noise emissions from digital apparatus set out in the Radio Interference Regulations of the Canadian Department of Communications.

This class B digital apparatus complies with Canadian ICES-003.

This Class B digital apparatus meets all requirements of the Canadian Interference - Causing Equipment Regulations.

Cet appareil numérique de la classe B respecte toutes les exigences du Règlement sur le matériel brouilleur du Canada.



Congratulations!

This product is TCO Certified – for Sustainable IT



TCO Certified is an international third party sustainability certification for IT products. TCO Certified ensures that the manufacture, use and recycling of IT products reflect environmental, social and economic responsibility. Every TCO Certified product model is verified by an accredited independent test laboratory.

This product has been verified to meet all the criteria in TCO Certified, including:

Corporate Social Responsibility

Socially responsible production - working conditions and labor law in manufacturing country

Energy Efficiency

Energy efficiency of product and power supply. Energy Star compliant, where applicable

Environmental Management System

Manufacturer must be certified according to either ISO 14001 or EMAS

Minimization of Hazardous Substances

Limits on cadmium, mercury, lead & hexavalent chromium including requirements for mercury-free products, halogenated substances and hazardous flame retardants

Design for Recycling

Coding of plastics for easy recycling. Limit on the number of different plastics used.

Product Lifetime, Product Take Back

Minimum one-year product warranty. Minimum three-year availability of spare parts. Product takeback

Packaging

Limits on hazardous substances in product packaging. Packaging prepared for recycling

Ergonomic, User-centered design

Visual ergonomics in products with a display. Adjustability for user comfort (displays, headsets)

Acoustic performance – protection against sound spikes (headsets) and fan noise (projectors, computers)

Ergonomically designed keyboard (notebooks)

Electrical Safety, minimal electro-magnetic Emissions

Third Party Testing

All certified product models have been tested in an independent, accredited laboratory.

A detailed criteria set is available for download at www.tcodevelopment.com, where you can also find a searchable database of all TCO Certified IT products.

TCO Development, the organization behind TCO Certified, has been an international driver in the field of Sustainable IT for 20 years. Criteria in TCO Certified are developed in collaboration with scientists, experts, users and manufacturers. Organizations around the world rely on TCO Certified as a tool to help them reach their sustainable IT goals. We are owned by TCO, a non-profit organization representing office workers. TCO Development is headquartered in Stockholm, Sweden, with regional presence in North America and Asia.

For more information, please visit
www.tcodevelopment.com

Safety information

- Before setting up the monitor, carefully read all the documentation that came with the package.
- To prevent fire or shock hazard, never expose the monitor to rain or moisture.
- Never try to open the monitor cabinet. The dangerous high voltages inside the monitor may result in serious physical injury.
- If the power supply is broken, do not try to fix it by yourself. Contact a qualified service technician or your retailer.
- Before using the product, make sure all cables are correctly connected and the power cables are not damaged. If you detect any damage, contact your dealer immediately.
- Slots and openings on the back or top of the cabinet are provided for ventilation. Do not block these slots. Never place this product near or over a radiator or heat source unless proper ventilation is provided.
- The monitor should be operated only from the type of power source indicated on the label. If you are not sure of the type of power supply to your home, consult your dealer or local power company.
- Use the appropriate power plug which complies with your local power standard.
- Do not overload power strips and extension cords. Overloading can result in fire or electric shock.
- Avoid dust, humidity, and temperature extremes. Do not place the monitor in any area where it may become wet. Place the monitor on a stable surface.
- Unplug the unit during a lightning storm or if it will not be used for a long period of time. This will protect the monitor from damage due to power surges.
- Never push objects or spill liquid of any kind into the slots on the monitor cabinet.
- To ensure satisfactory operation, use the monitor only with UL listed computers which have appropriate configured receptacles marked between 100-240V AC.
- If you encounter technical problems with the monitor, contact a qualified service technician or your retailer.
- Adjustment of the volume control as well as the equalizer to other settings than the center position may increase the ear-/headphones output voltage and therefore the sound pressure level.



This symbol of the crossed out wheeled bin indicates that the product (electrical, electronic equipment, and mercury-containing button cell battery) should not be placed in municipal waste. Please check local regulations for disposal of electronic products.

AEEE yönetmeliğine uygundur

Care & Cleaning

- Before you lift or reposition your monitor, it is better to disconnect the cables and power cord. Follow the correct lifting techniques when positioning the monitor. When lifting or carrying the monitor, grasp the edges of the monitor. Do not lift the display by the stand or the cord.
- Cleaning. Turn your monitor off and unplug the power cord. Clean the monitor surface with a lint-free, non-abrasive cloth. Stubborn stains may be removed with a cloth dampened with mild cleaner.
- Avoid using a cleaner containing alcohol or acetone. Use a cleaner intended for use with the monitor. Never spray cleaner directly on the screen, as it may drip inside the monitor and cause an electric shock.

The following symptoms are normal with the monitor:

- You may find slightly uneven brightness on the screen depending on the desktop pattern you use.
- When the same image is displayed for hours, an afterimage of the previous screen may remain after switching the image. The screen will recover slowly or you can turn off the Power Switch for hours.
- When the screen becomes black or flashes, or cannot work anymore, contact your dealer or service center to fix it. Do not repair the screen by yourself!

Conventions used in this guide



WARNING: Information to prevent injury to yourself when trying to complete a task.



CAUTION: Information to prevent damage to the components when trying to complete a task.



IMPORTANT: Information that you **MUST** follow to complete a task.



NOTE: Tips and additional information to aid in completing a task.

Where to find more information

Refer to the following sources for additional information and for product and software updates.

1. **ASUS websites**

The ASUS websites worldwide provide updated information on ASUS hardware and software products. Refer to <http://www.asus.com>

2. **Optional documentation**

Your product package may include optional documentation that may have been added by your dealer. These documents are not part of the standard package.

Takeback Services

ASUS recycling and takeback programs come from our commitment to the highest standards for protecting our environment. We believe in providing solutions for our customers to be able to responsibly recycle our products, batteries and other components as well as the packaging materials.

Please go to <http://csr.asus.com/english/Takeback.htm> for detail recycling information in different region.

1.1 Welcome!

Thank you for purchasing the ASUS® LCD monitor!

The latest widescreen LCD monitor from ASUS provides a broader, brighter and crystal-clear display, plus a host of features that enhance your viewing experience.

With these features, you can enjoy the convenience and delightful visual experience that the monitor brings to you!

1.2 Package contents

Check your package for the following items:

- ✓ LCD monitor
- ✓ Monitor base
- ✓ Quick start guide
- ✓ Warranty card
- ✓ Power cord
- ✓ DVI cable (for selected models)
- ✓ HDMI cable (for selected models)
- ✓ DisplayPort cable (for selected models)
- ✓ DisplayPort cable (Mini-DP to DP) (for selected models)
- ✓ VGA cable (for selected models)
- ✓ USB cable (for selected models)
- ✓ Audio cable
- ✓ MiniPC Kit (for selected models)



If any of the above items is damaged or missing, contact your retailer immediately.

1.3 Monitor introduction

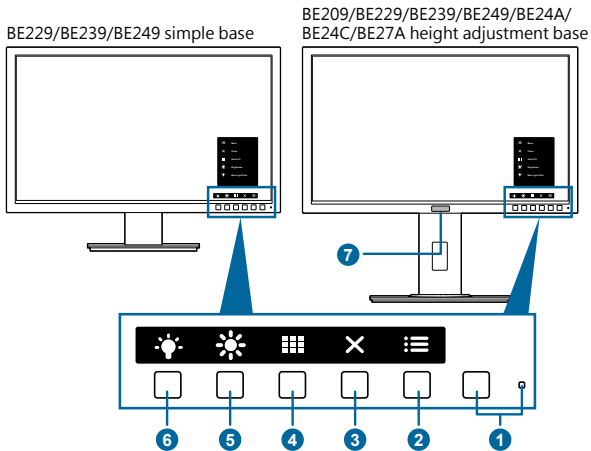

1.3.1 Front view



1. Power button/power indicator
 - Turns the monitor on/off.
 - The color definition of the power indicator is as the below table.

Status	Description
White	On
Amber	Standby mode
Off	Off

2. Menu button:
 - Press this button to display the OSD menu when the OSD is off.
 - Enters the OSD menu.
 - Toggles the Key Lock function between on and off with a long press for 5 seconds.
3. Close button:
 - Press this button to display the OSD menu when the OSD is off.
 - Exits the OSD menu.
4. QuickFit button:
 - Press this button to display the OSD menu when the OSD is off.
 - This is a hotkey to activate the QuickFit function designed for alignment.

- The QuickFit function contains pages of common grid patterns, paper sizes, and photo sizes. (Please refer to 1.3.3 QuickFit Function).
5.  **Shortcut 1**
 - Press this button to display the OSD menu when the OSD is off.
 - Default: Brightness hotkey
 - To change the hotkey function, go to the Shortcut > Shortcut 1 menu.
 6.  **Shortcut 2**
 - Press this button to display the OSD menu when the OSD is off.
 - Default: Blue light filter hotkey
 - To change the hotkey function, go to the Shortcut > Shortcut 2 menu.
 7. Human Sensor (only for BE239QLBR):
 - Detects user's presence in front of the monitor screen. The monitor automatically enters standby mode when no moving object in front of the monitor is detected for longer than 60 seconds. When the user comes back, the power resumes automatically when it detects the user's presence. The default setting of Human sensor is "Off". User can activate this function through OSD settings.

1.3.2 Back view

BE229Q/BE239Q/BE249Q

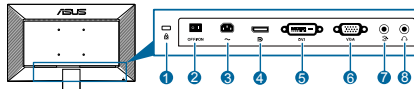

BE229QB/BE239QB/
BE249QB

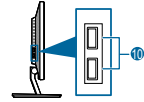
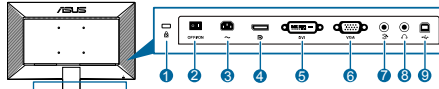

BE209QL/BE229QL/
BE239QL/BE249QL

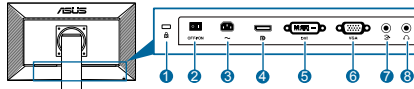

BE209TL

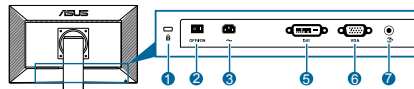

BE209QLB/BE229QLB/
BE239QLB/BE239QLBR/
BE249QLB/BE24AQLB

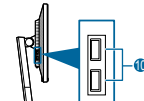
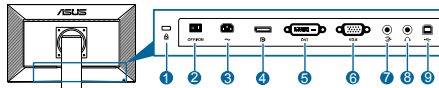

BE209TLB

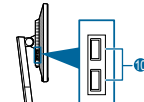
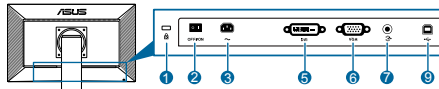

BE24C

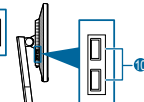
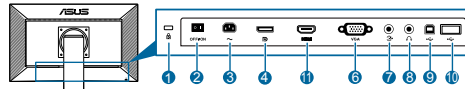

BE27AQLB

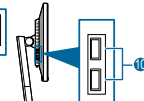
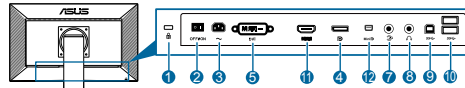

BE229QLBH/BE239QLBH/
BE249QLBH/BE24AQLBH

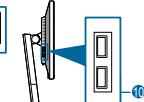
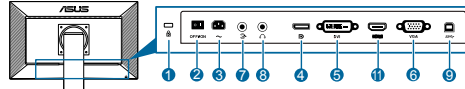

1. **Kensington lock slot.**
2. **Power switch.** Press the switch to turn on/off power.
3. **AC-IN port.** This port connects the power cord.

4. **DisplayPort in.** This port is for connection with a DisplayPort compatible device.
5. **DVI port.** This 24-pin port is for PC (Personal Computer) DVI-D digital signal connection.
6. **VGA port.** This 15-pin port is for PC VGA connection.
7. **Audio-in port.** This port connects PC audio source by the bundled audio cable.
8. **Earphone jack.** This port is only available when an HDMI/DisplayPort cable is connected.
9. **USB upstream port.** This port is for connection with a USB upstream cable. The connection enables the USB ports on the monitor.
10. **USB downstream ports.** These ports are for connection with USB devices, such as USB keyboard/mouse, USB flash drive, etc.
11. **HDMI port.** This port is for connection with an HDMI compatible device.
12. **Mini DisplayPort in.** This port is for connection with a Mini DisplayPort compatible device.

1.3.3 QuickFit Function

The QuickFit function contains three kinds of patterns: (1) Grid patterns (2) Paper size (3) Photo size. To activate the patterns, press the QuickFit button. Press the buttons as indicated on the screen to select a desired pattern.



Some of the following patterns may not be available. Please refer to the actual patterns shown on your monitor.

1. Grid patterns

The grid patterns facilitate users to efficiently organize and compare various contents, such as spreadsheet viewing and photo editing.

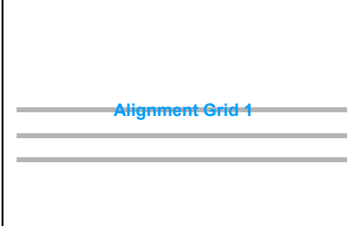
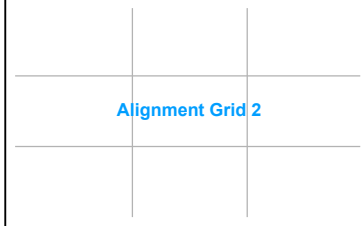
Alignment Grid 1	Alignment Grid 2
	

2. Paper size

QuickFit provides several commonly used standard paper sizes for users to view their documents in real size on the screen.

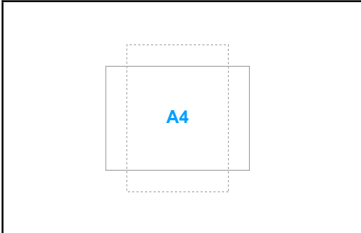
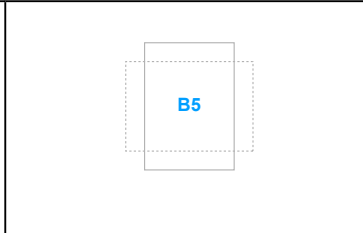
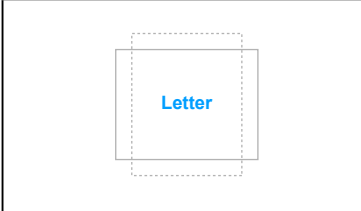
A4	B5
	
Letter	
	

3. Photo size

The various real photo sizes displayed in the QuickFit function provides photographers and other users to accurately view and edit their photos in real size on the screen.

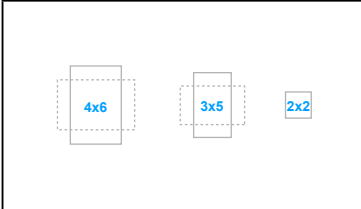
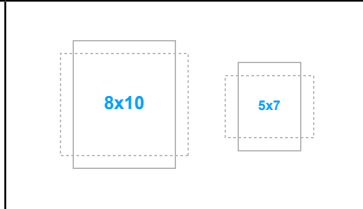
Photo 4x6, 3x5, 2x2	Photo 8x10, 5x7
	

2.1 Assembling the monitor arm/base

To assemble the monitor base:

1. Have the front of the monitor face down on a table.
2. Attach the base into the arm, making sure the tab on the arm fits into the groove on the base.
3. Fix the base to the arm by fastening the bundled screw.



We recommend that you cover the table surface with soft cloth to prevent damage to the monitor.

BE229/BE239/BE249 simple base

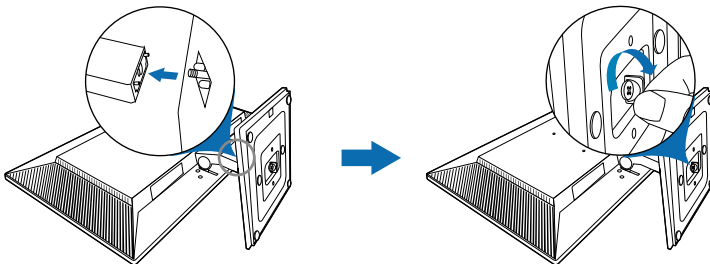

BE209/BE229/BE239/BE249/BE24A/BE24C/BE27A height adjustment base

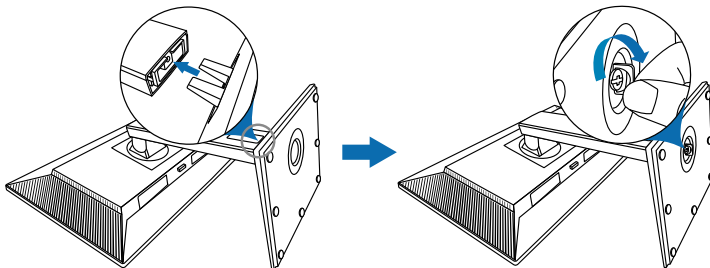

2.2 Detaching the arm/base (for VESA wall mount)

The detachable arm/base of this monitor is specially designed for VESA wall mount.

To detach the arm/base:

BE229/BE239/BE249 simple base

1. Have the front of the monitor face down on a table.
2. Remove the rubbers in the four screw holes. (Figure 1)
3. Remove the base (Figure 2).
4. Use a screwdriver to remove the screw on the hinge (Figure 3), then remove the hinge.

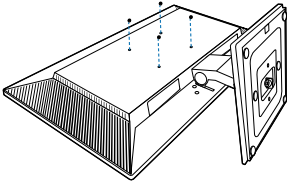

(Figure 1)

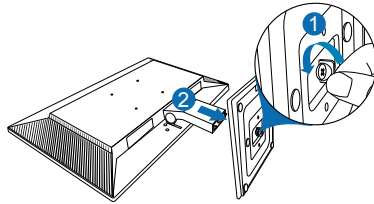

(Figure 2)

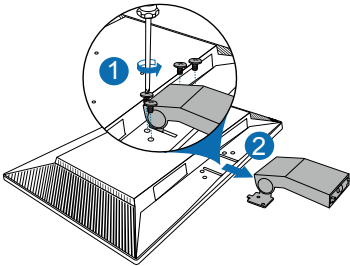

(Figure 3)

BE209/BE229/BE239/BE249/BE24A/BE24C/BE27A height adjustment base

1. Have the front of the monitor face down on a table.
2. Press the release button, and then detach the arm/base from the monitor (Figure 2).

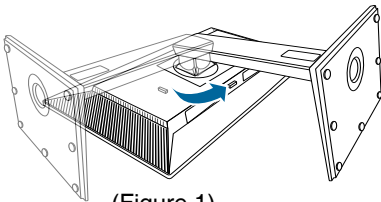

(Figure 1)

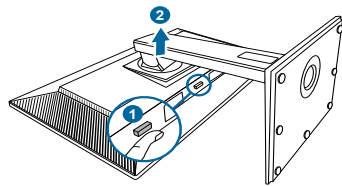

(Figure 2)



We recommend that you cover the table surface with soft cloth to prevent damage to the monitor.



- The VESA wall mount kit (100 x 100 mm) is purchased separately.
- Use only the UL Listed Wall Mount Bracket with minimum weight/load 22.7kg (Screw size: M4 x 10 mm)

2.3 Attaching/Removing the MiniPC Kit (BE209/BE229/BE239/BE249/BE24A/BE24C/BE27A height adjustment base)

Attaching the MiniPC Kit

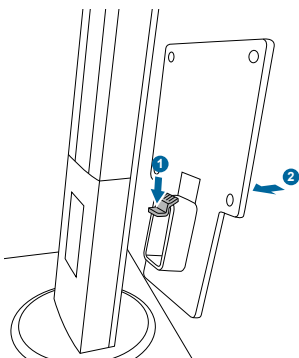

Removing the MiniPC Kit

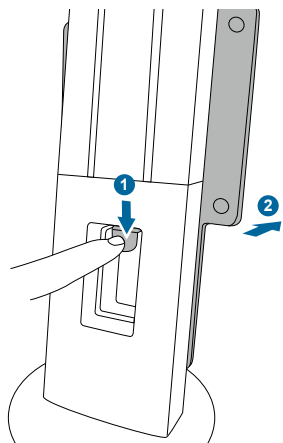

2.4 Adjusting the monitor

- For optimal viewing, we recommend that you look at the full face of the monitor, then adjust the monitor to the angle that is most comfortable for you.
- Hold the stand to prevent the monitor from falling when you change its angle.
- BE229/BE239/BE249 simple base: The recommended adjusting angle is +20 to -5°.
- BE209/BE229/BE239/BE249/BE24A/BE24C height adjustment base: You can adjust the monitor's angle from +35° to -5° and it allows 90° swivel adjustment from either left or right. You can also adjust the monitor's height within +/- 130 mm.
- BE27A height adjustment base: You can adjust the monitor's angle from +35° to -5° and it allows 90° swivel adjustment from either left or right. You can also adjust the monitor's height within +/- 150 mm.

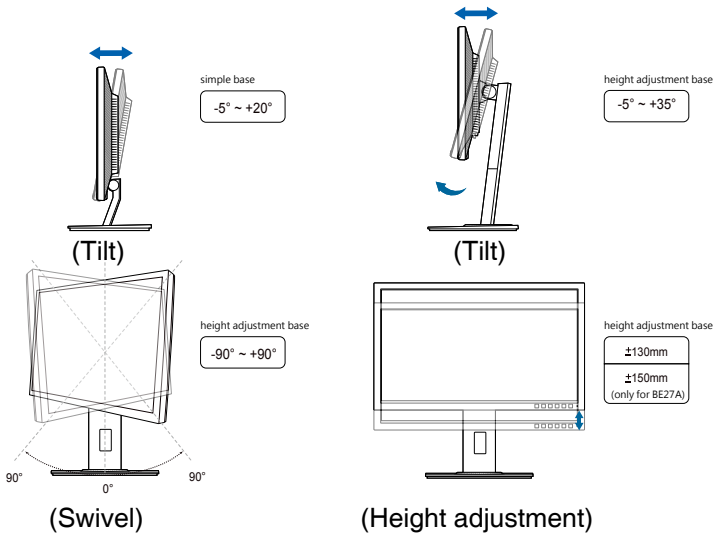

Pivoting the monitor (BE209/BE229/BE239/BE249/BE24A/BE24C/BE27A height adjustment base)

1. Lift the monitor to the highest position.
2. Tilt the monitor to its maximum angle.
3. Pivot the monitor clockwise/counterclockwise to the angle you need.

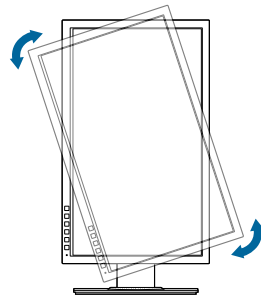
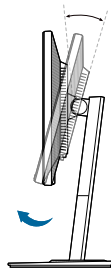
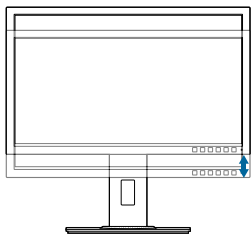

It is normal that the monitor slightly shakes while you adjust the viewing angle.

2.5 Connecting the cables

Connect the cables as the following instructions:

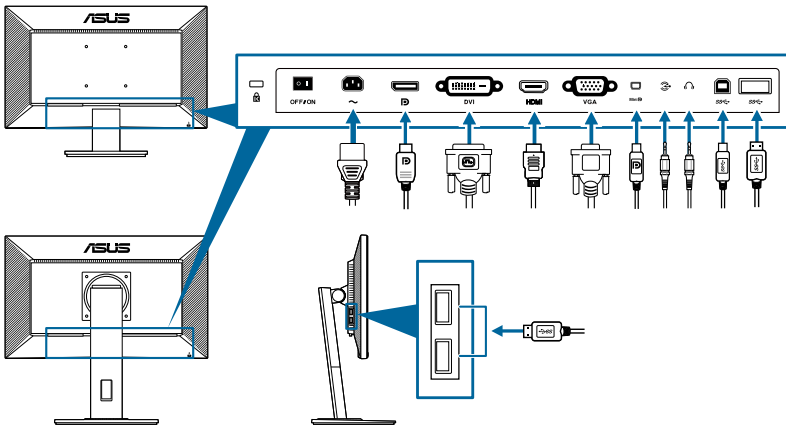



- **To connect the power cord:** Connect one end of the power cord securely to the monitor's AC input port, the other end to a power outlet.
- **To connect the VGA/DVI/DisplayPort/HDMI/Mini DisplayPort cable:**
 - a. Plug one end of the VGA/DVI/DisplayPort/HDMI/Mini DisplayPort cable to the monitor's VGA/DVI/DisplayPort/HDMI/Mini DisplayPort jack.
 - b. Connect the other end of the VGA/DVI/DisplayPort/HDMI/Mini DisplayPort cable to your computer's VGA/DVI/DisplayPort/HDMI/Mini DisplayPort jack.
 - c. Tighten the two screws to secure the VGA/DVI connector.

- **To connect the audio cable:** connect one end of the audio cable to the monitor's Audio-in port, the other end to the computer's audio-out port.
- **To use the earphone:** connect the end with plug type to the monitor's earphone jack when an HDMI or DisplayPort signal is fed.
- **To use the USB 2.0 ports:** Take the supplied USB 2.0 cable, and plug the smaller end (type B) of the USB upstream cable to the monitor's USB upstream port, and the larger end (type A) to your computer's USB 2.0 port. Make sure your computer is installed with the latest Windows 7/Windows 8 operating system. That will enable the USB ports on the monitor to work.
- **To use the USB 3.0 ports:** Take the supplied USB 3.0 cable, and plug the smaller end (type B) of the USB upstream cable to the monitor's USB upstream port, and the larger end (type A) to your computer's USB 3.0 port. Make sure your computer is installed with the latest Windows 7/Windows 8.1/Windows 10 operating system. That will enable the USB ports on the monitor to work.



When these cables are connected, you can choose the desired signal from the Input Select item in the OSD menu.

2.6 Turning on the monitor

Press the power button . See page 1-2 for the location of the power button. The power indicator  lights up in white to show that the monitor is ON.

3.1 OSD (On-Screen Display) menu

3.1.1 How to reconfigure

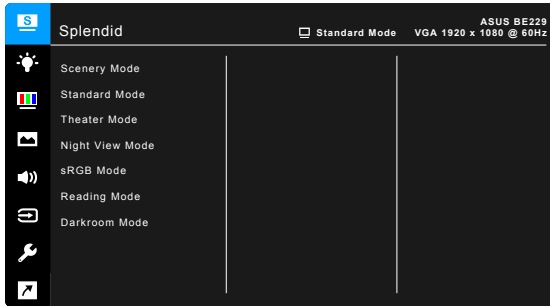

1. Press any button (except the Power button) to display the OSD menu.
2. Press the Menu button to activate the OSD menu.
3. Press the buttons as indicated on the screen to navigate through the functions. Highlight the desired function and press to activate it. If the function selected has a sub-menu, press and again to navigate through the sub-menu functions. Highlight the desired sub-menu function and press to activate it.
4. Press and to change the settings of the selected function.
5. To exit and save the OSD menu, press or repeatedly until the OSD menu disappears. To adjust other functions, repeat steps 1-4.

3.1.2 OSD function introduction

1. Splendid

This function contains 7~8 sub-functions you can select for your preference. Each mode has the Reset selection, allowing you to maintain your setting or return to the preset mode.

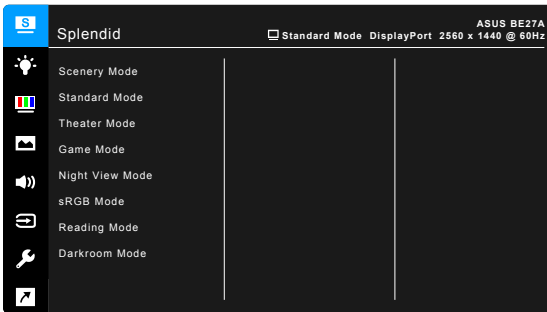
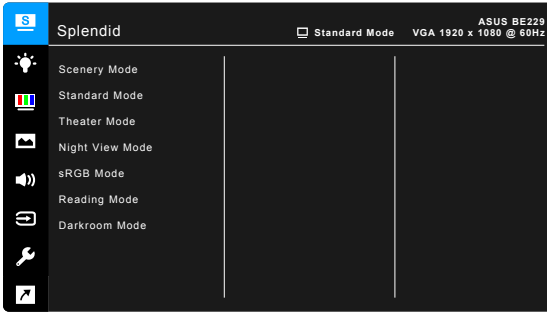

- **Scenery Mode:** Best choice for scenery photo display with SplendidPlus Video Enhancement.
- **Standard Mode:** Best choice for document editing with SplendidPlus Video Enhancement.
- **Theater Mode:** Best choice for movies with SplendidPlus Video Enhancement.
- **Game Mode (only for BE27A):** Best choice for games playing with SplendidPlus Video Enhancement.
- **Night View Mode:** Best choice for dark-scene games or movies with SplendidPlus Video Enhancement.
- **sRGB Mode:** best choice for viewing photos and graphics from PCs.

- **Reading Mode:** This is the best choice for book reading.
- **Darkroom Mode:** This is the best choice for a weak ambient light environment.



-
- In the Standard mode, the following function(s) are not user-configurable: Saturation, Skin Tone, Sharpness, ASCR.
 - In the sRGB mode, the following function(s) are not user-configurable: Brightness, Contrast, Saturation, Color Temp., Skin Tone, Sharpness, ASCR.
 - In the Reading mode, the following function(s) are not user-configurable: Contrast, Saturation, Color Temp., Skin Tone, Sharpness, ASCR.
-

2. Blue Light Filter

In this function, you can adjust the blue light filter level.

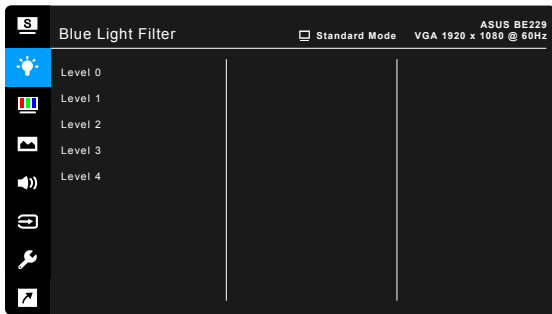

- **Level 0:** No change.
- **Level 1~4:** The higher the level, the less blue light is scattered. When Blue Light Filter is activated, the default settings of Standard Mode will be automatically imported. Between Level 1 to Level 3, the Brightness function is user-configurable. Level 4 is optimized setting. It is compliance with TUV Low Blue Light Certification. The Brightness function is not user-configurable.



Please refer to the following to alleviate eye strains:

- Users should take some time away from the display if working for long hours. It is advised to take short breaks (at least 5 mins) after around 1 hour of continuous working at the computer. Taking short and frequent breaks is more effective than a single longer break.
- To minimize eye strain and dryness in your eyes, users should rest the eye periodically by focusing on objects that are far away.

- Eye exercises can help to reduce eye strain. Repeat these exercises often. If eye strain continues, please consult a physician. Eye exercises: (1) Repeating look up and down (2) Slowly roll your eyes (3) Move your eyes diagonal.
- High energy blue light may lead to eye strain and AMD (Age-Related Macular Degeneration). Blue light Filter to reduce 70% (max.) harmful blue light to avoid CVS (Computer Vision Syndrome).

3. Color

Set a desired color setting from this menu.



- **Brightness:** The adjusting range is from 0 to 100.
- **Contrast:** The adjusting range is from 0 to 100.
- **Saturation:** The adjusting range is from 0 to 100.
- **Color Temp.:** Contains 4 modes including Cool, Normal, Warm and User Mode.
- **Skin Tone:** contains three color modes including Reddish, Natural, and Yellowish.

4. Image

Set the image related setting from this menu.

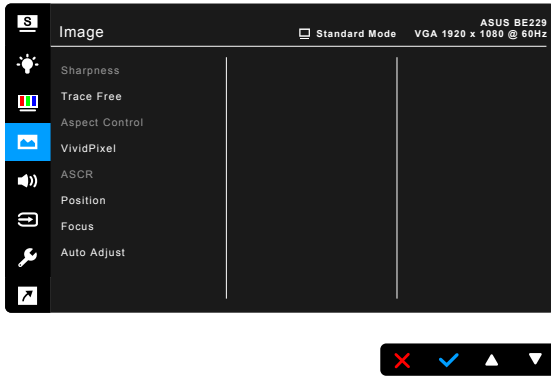

- **Sharpness:** The adjusting range is from 0 to 100.
- **Trace Free:** Adjusts the response time of the monitor.
- **Aspect Control:** Adjusts the aspect ratio to full, 4:3, 1:1 (optional) or OverScan (optional).



4:3 is only available when input source is in 4:3 format. OverScan is only available for the HDMI input source.

- **VividPixel:** Enhances the outline of the displayed picture and generates high-quality images on screen.
- **ASCR:** Turns on/off the ASCR (ASUS Smart Contrast Ratio) function.
- **Position (Only available for VGA input):** adjusts the horizontal position (H-Position) and the vertical position (V-Position) of the image. The adjusting range is from 0 to 100.
- **Focus (Only available for VGA input):** reduces Horizontal-line noise and Vertical-line noise of the image by adjusting (Phase) and (Clock) separately. The adjusting range is from 0 to 100.



- Phase adjusts the phase of the pixel clock signal. With a wrong phase adjustment, the screen shows horizontal disturbances.
 - Clock (pixel frequency) controls the number of pixels scanned by one horizontal sweep. If the frequency is not correct, the screen shows vertical stripes and the image is not proportional.
-
- **Auto Adjust.:** Automatically adjusts the image to its optimized position, clock, and phase (for VGA mode only).

5. Sound

You can adjust Volume, Mute and Source from this menu.



- **Volume:** the adjusting range is from 0 to 100.
- **Mute:** toggles the monitor sound between on and off.
- **Source:** decides the monitor sound comes from which source.

6. Input Select

In this function, you can select your desired input source.

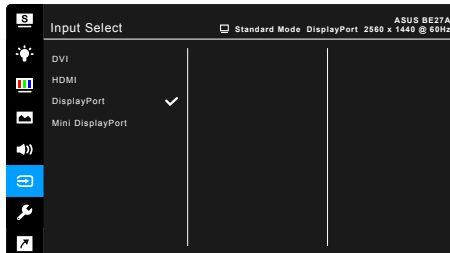
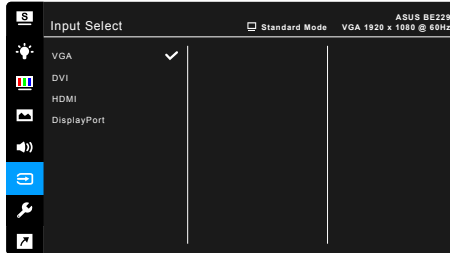

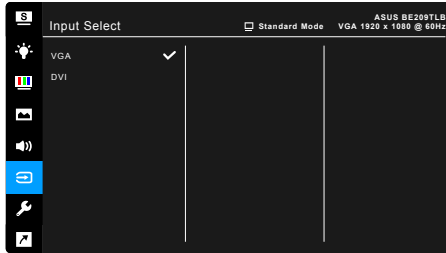

7. System Setup

Allows you to adjust the system.

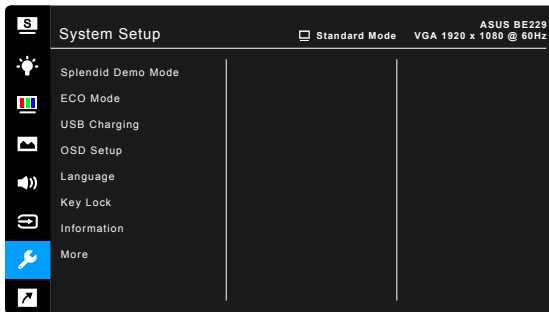

- **Splendid Demo Mode:** Splits the screen into two for Splendid modes comparison. (Scenery mode only)
- **ECO Mode:** reduces power consumption.
- **USB Charging (only for BE229QB/BE239QB/BE249QB/BE209QLB/BE209TLB/BE229QLB/BE239QLB/BE239QLBR/BE249QB/BE24AQLB/BE24CQLB/BE27AQLB/BE229QLBH/BE239QLBH/BE249QLBH/BE24AQLBH):**
 - * “On” allows the USB downstream ports to generate a 5V/500mA output when the monitor is turned on or in standby mode.
 - * “Off” allows the USB downstream ports to generate a 5V/500mA output only when the monitor is turned on.
- **OSD Setup:**
 - * Adjusts the OSD timeout from 10 to 120 seconds.
 - * Enables or disables the DDC/CI function.
 - * Adjusts the OSD background from opaque to transparent.

- **Language:** There are 21 languages for your selection, including English, French, German, Italian, Spanish, Dutch, Portuguese, Russian, Czech, Croatian, Polish, Romanian, Hungarian, Turkish, Simplified Chinese, Traditional Chinese, Japanese, Korean, Thai, Indonesia, Persian.
- **Keylock:** To disable all function keys. Press the second button from the right over five seconds to cancel the key lock function.
- **Auto Source Detection:** Enables or disables the auto source detecting function.
- **Information:** Shows the monitor information.
- **Power Indicator:** Turns the power LED indicator on/off.
- **Human Sensor (only for BE239QLBR):** turns on/ off the Human Sensor function and adjusts its sensitivity. The effective range is from 50 to 70 cm. The default setting is Off.
 - * Low: Sensor distance is around 50 cm.
 - * Medium: Sensor distance is around 60 cm.
 - * High: Sensor distance is around 70 cm.



- The detective range may be slightly different if user wears dark or bright colored clothing. Set the sensitivity to High when wearing black or other dark clothes.
- Please do not put any object too close to the Human Sensor to avoid any interference.

- **Power Key Lock:** Enables or disables the power key.
- **All Reset:** “Yes” allows you to restore the default settings.

8. Shortcut

Defines the functions for Shortcut 1 and 2 buttons.

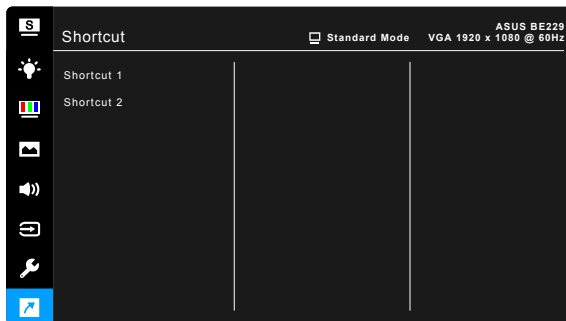

- **Shortcut 1/Shortcut 2:** selects a function for Shortcut 1 and 2 buttons.



When a certain function is selected or activated, your shortcut key may not support. Available function choices for shortcut: Blue Light Filter, Splendid, Brightness, Auto Adjust, Contrast, Color Temp., Volume.

3.2 Specifications summary

BE229/BE239/BE249 simple base

Panel Type	TFT LCD
Panel size	BE229QB/BE229Q: 21.5" (16:9, 54.6 cm) wide screen BE239QB/BE239Q: 23" (16:9, 58.4 cm) wide screen BE249QB/BE249Q: 23.8" (16:9, 60.5 cm) wide screen
Max. Resolution	BE229QB/BE229Q: 1920 x 1080 BE239QB/BE239Q: 1920 x 1080 BE249QB/BE249Q: 1920 x 1080
Pixel pitch	BE229QB/BE229Q: 0.248 mm x 0.248 mm BE239QB/BE239Q: 0.2652 mm x 0.2652 mm BE249QB/BE249Q: 0.2745 mm x 0.2745 mm
Brightness (Typ.)	250 cd/m ²
Contrast Ratio (Typ.)	1000:1
Contrast Ratio (Max.)	100,000,000:1 (with ASCR on)
Viewing angle (H/V) CR>10	178°/178°
Display colors	16.7 M
Response time	≤ 5 ms
SplendidPlus Video Enhancement	Yes
SplendidPlus selection	7 video preset modes
Auto adjustment	Yes
Color temperature selection	4 color temperatures
Analog input	D-sub
Digital input	DVI-D with HDCP, DisplayPort v1.2
Earphone jack	Yes
Audio input	Yes
Speaker (Built-in)	2 W x 2 Stereo, RMS
USB 2.0 port	Upstream x 1, Downstream x 2 (only for BE229QB/ BE239QB/BE249QB)
Colors	Black
Power LED	White (On)/Amber (Standby)
Tilt	+20° ~ -5°
Pivot	No
Swivel	No
Height Adjustment	No
Kensington lock	Yes
AC input voltage	AC: 100~240V
Power consumption	BE229QB/BE229Q: Power On: < 21.09 W** (Typ.), Standby: < 0.5 W (Typ.), Power Off: 0 W (Switch off) BE239QB/BE239Q: Power On: < 22 W** (Typ.), Standby: < 0.5 W (Typ.), Power Off: 0 W (Switch off) BE249QB/BE249Q: Power On: < 22.97 W** (Typ.), Standby: < 0.5 W (Typ.), Power Off: 0 W (Switch off)
Temperature (Operating)	0°C~40°C
Temperature (Non-operating)	-20°C~+60°C

Dimension (W x H x D) with stand	BE229QB/BE229Q: 514 x 383 x 195 mm (machine), 576 x 442 x 120 mm (package) BE239QB/BE239Q: 548 x 403 x 195 mm (machine), 617 x 119 x 462 mm (package) BE249QB/BE249Q: 562 x 406 x 195 mm (machine), 632 x 127 x 465 mm (package)
Weight (Esti.)	BE229QB/BE229Q: 3.8 kg (Net); 5.3 kg (Gross) BE239QB/BE239Q: 4.3 kg (Net); 5.7 kg (Gross) BE249QB/BE249Q: 4.3 kg (Net); 5.9 kg (Gross)
Multi-languages	21 languages (English, French, German, Italian, Spanish, Dutch, Portuguese, Russian, Czech, Croatian, Polish, Romanian, Hungarian, Turkish, Simplified Chinese, Traditional Chinese, Japanese, Korean, Thai, Indonesia, Persian)
Accessories	Power cord, DVI cable (optional), DisplayPort cable, VGA cable, Audio cable, USB cable (only for BE229QB/BE239QB/BE249QB), Quick start guide, Warranty card
Compliance and Standards	UL/cUL, CB, CE, ErP, FCC, ISO9241-307, RCM, VCCI, RoHS, Windows 7 & 8 WHQL, Energy Star®, EPEAT Gold, TCO 7.0, Flicker Free, Low blue Light, TUV-GS, TUV-Ergo, CU, PSE, WEEE, EMC DoC, UkrSEPRO, MEPS

*Specifications are subject to change without notice.

**measuring a screen brightness of 200 nits without audio/USB/Card reader connection.

BE209/BE229/BE239/BE249/BE24A/BE24C height adjustment base

Panel Type	TFT LCD
Panel size	BE209QLB/BE209QL: 19.45" (16:10, 49.4 cm) wide screen BE229QLB/BE229QL/BE229QLBH: 21.5" (16:9, 54.6 cm) wide screen BE239QLB/BE239QL/BE239QLBR/BE239QLBH: 23" (16:9, 58.4 cm) wide screen BE249QLB/BE249QL/BE24CQLB/BE249QLBH: 23.8" (16:9, 60.5 cm) wide screen BE24AQLB/BE24AQLBH: 24" (16:10, 61.13 cm) wide screen
Max. Resolution	BE209QLB/BE209QL: 1440 x 900 BE229QLB/BE229QL/BE229QLBH: 1920 x 1080 BE239QLB/BE239QL/BE239QLBR/BE239QLBH: 1920 x 1080 BE249QLB/BE249QL/BE249QLBH: 1920 x 1080 BE24AQLB/BE24AQLBH: 1920 x 1200 BE24CQLB: 2560 x 1440
Pixel pitch	BE209QLB/BE209QL: 0.2907 mm x 0.2915 mm BE229QLB/BE229QL/BE229QLBH: 0.248 mm x 0.248 mm BE239QLB/BE239QL/BE239QLBR/BE239QLBH: 0.2652 mm x 0.2652 mm BE249QLB/BE249QL/BE249QLBH: 0.2745 mm x 0.2745 mm BE24AQLB/BE24AQLBH: 0.270 mm x 0.270 mm BE24CQLB: 0.2058 mm x 0.2058 mm
Brightness (Typ.)	BE209QLB/BE209QL/BE229QLB/BE229QL/ BE229QLBH/BE239QLB/BE239QL/BE239QLBR/ BE239QLBH/BE249QLB/BE249QL/BE249QLBH/ BE24AQLB: 250 cd/m ² BE24CQLB/BE24AQLBH: 300 cd/m ²
Contrast Ratio (Typ.)	1000:1
Contrast Ratio (Max.)	100,000,000:1 (with ASCR on)
Viewing angle (H/V) CR>10	178°/178°
Display colors	16.7 M
Response time	≤ 5 ms
SplendidPlus Video Enhancement	Yes
SplendidPlus selection	7 video preset modes
Auto adjustment	Yes
Color temperature selection	4 color temperatures
Analog input	D-sub
Digital input	DVI-D with HDCP, DisplayPort v1.2, HDMI (only for BE229QLBH/BE239QLBH/BE249QLBH/BE24AQLBH/BE24C)
Earphone jack	Yes

Audio input	Yes
Speaker (Built-in)	2 W x 2 Stereo, RMS
USB 2.0 port	Upstream x 1, Downstream x 2 (only for BE209QLB/BE229QLB/BE239QLB/BE239QLBR/BE249QLB/BE24AQLB), Downstream x 3 (only for BE24CQLB)
USB 3.0 port	BE229QLBH/BE239QLBH/BE249QLBH/BE24AQLBH: Upstream x 1, Downstream x 2
Colors	Black/Gray
Power LED	White (On)/Amber (Standby)
Tilt	+35° ~ -5°
Pivot	+90° ~ -90°
Swivel	+90° ~ -90°
Height Adjustment	130 mm
Kensington lock	Yes
AC input voltage	AC: 100~240V
Power consumption	BE209QLB/BE209QL: Power On: < 15.74 W** (Typ.), Standby: < 0.5 W (Typ.), Power Off: 0 W (Switch off) BE229QLB/BE229QL/BE229QLBH: Power On: < 21.09 W** (Typ.), Standby: < 0.5 W (Typ.), Power Off: 0 W (Switch off) BE239QLB/BE239QL/BE239QLBR/BE239QLBH: Power On: < 22 W** (Typ.), Standby: < 0.5 W (Typ.), Power Off: 0 W (Switch off) BE249QLB/BE249QL/BE249QLBH: Power On: < 22.97 W** (Typ.), Standby: < 0.5 W (Typ.), Power Off: 0 W (Switch off) BE24AQLB/BE24AQLBH: Power On: < 25.4 W** (Typ.), Standby: < 0.5 W (Typ.), Power Off: 0 W (Switch off) BE24CQLB: Power On: < 32.64 W** (Typ.), Standby: < 0.5 W (Typ.), Power Off: 0 W (Switch off)
Temperature (Operating)	0°C~40°C
Temperature (Non-operating)	-20°C~+60°C

Dimension (W x H x D) with stand	BE209QLB/BE209QL: 459 x 477 x 211 mm (highest), 459 x 347 x 211 mm (lowest), 621 x 173 x 382 mm (package) BE229QLB/BE229QL/BE229QLBH: 514 x 477 x 211 mm (highest), 514 x 347 x 211 mm (lowest), 643 x 378 x 190 mm (package) BE239QLB/BE239QL/BE239QLBR/BE239QLBH: 548 x 490 x 211 mm (highest), 548 x 360 x 211 mm (lowest), 652 x 173 x 403 mm (package) BE249QLB/BE249QL/BE249QLBH/BE24CQLB: 562 x 492 x 211 mm (highest), 562 x 362 x 211 mm (lowest), 660 x 180 x 420 mm (package) BE24AQLB/BE24AQLBH: 561 x 511 x 211 mm (highest), 561 x 381 x 211 mm (lowest), 662 x 179 x 454 mm (package)
Weight (Esti.)	BE209QLB/BE209QL: 4.8 kg (Net); 6.4 kg (Gross) BE229QLB/BE229QL/BE229QLBH: 5.7 kg (Net); 7.2 kg (Gross) BE239QLB/BE239QL/BE239QLBR/BE239QLBH: 5.7 kg (Net); 7.3 kg (Gross) BE249QLB/BE249QL/BE249QLBH: 5.8 kg (Net); 7.9 kg (Gross) BE24AQLB/BE24AQLBH: 6.2 kg (Net); 8.2 kg (Gross) BE24CQLB: 5.9 kg (Net); 7.9 kg (Gross)
Multi-languages	21 languages (English, French, German, Italian, Spanish, Dutch, Portuguese, Russian, Czech, Croatian, Polish, Romanian, Hungarian, Turkish, Simplified Chinese, Traditional Chinese, Japanese, Korean, Thai, Indonesia, Persian)
Accessories	Power cord, DVI cable (optional), HDMI cable (only for BE24C), DisplayPort cable, VGA cable, Audio cable, USB cable (only for BE209QLB/BE229QLB/BE239QLB/BE239QLBR/BE249QLB/BE24AQLB/BE24CQLB), Quick start guide, Warranty card
Compliance and Standards	UL/cUL, CB, CE, ErP, FCC, ISO9241-307, RCM, VCCI, RoHS, Windows 7 & 8 & 10 WHQL, Energy Star®, EPEAT Gold, TCO 7.0, Flicker Free, Low blue Light, TUV-GS, TUV-Ergo, CU, PSE, WEEE, EMC DoC, UkrSEPRO, MEPS, BSMI

*Specifications are subject to change without notice.

**measuring a screen brightness of 200 nits without audio/USB/Card reader connection.

BE27A

Panel Type	TFT LCD
Panel size	27" (16:9, 68.47 cm) wide screen
Max. Resolution	2560 x 1440
Pixel pitch	0.2331 mm x 0.2331 mm
Brightness (Typ.)	350 cd/m ²

Contrast Ratio (Typ.)	1000:1
Contrast Ratio (Max.)	100,000,000:1 (with ASCR on)
Viewing angle (H/V) CR>10	178°/178°
Display colors	16.7 M
Response time	≤ 5 ms
SplendidPlus Video Enhancement	Yes
SplendidPlus selection	8 video preset modes
Auto adjustment	Yes
Color temperature selection	4 color temperatures
Analog input	No
Digital input	DVI-D with HDCP, DisplayPort v1.2, HDMI, mini DisplayPort
Earphone jack	Yes
Audio input	Yes
Speaker (Built-in)	2 W x 2 Stereo, RMS
USB 3.0 port	Upstream x 1, Downstream x 4
Colors	Black
Power LED	White (On)/Amber (Standby)
Tilt	+35° ~ -5°
Pivot	+90° ~ -90°
Swivel	+90° ~ -90°
Height Adjustment	150 mm
Kensington lock	Yes
AC input voltage	AC: 100~240V
Power consumption	Power On: < 75 W** (Typ.), Standby: < 0.5 W (Typ.), Power Off: 0 W (Switch off)
Temperature (Operating)	0°C~40°C
Temperature (Non-operating)	-20°C~+60°C
Dimension (W x H x D) without stand	615 x 372 x 51 mm
Dimension (W x H x D) with stand	615 x 532 x 226 mm (highest), 615 x 382 x 226 mm (lowest), 735 x 216 x 464 mm (package)
Weight (Esti.)	7.7 kg (Net); 5 kg (Without stand); 10.8 kg (Gross)
Multi-languages	21 languages (English, French, German, Italian, Spanish, Dutch, Portuguese, Russian, Czech, Croatian, Polish, Romanian, Hungarian, Turkish, Simplified Chinese, Traditional Chinese, Japanese, Korean, Thai, Indonesia, Persian)
Accessories	Power cord, DVI cable (optional), HDMI cable, DisplayPort cable (optional), DisplayPort cable (Mini-DP to DP), Audio cable, USB cable, Quick start guide, Warranty card

Compliance and Standards

UL/cUL, FCC, ICES-3, EPEAT(GOLD), CB, CE, ErP, WEEE, TUV-GS, TUV-Ergo, ISO 9241-307, UkrSEPRO, CU, CCC, CEL, BSMI, RCM, MEPS, VCCI, PSE, PC Recycle, J-MOSS, KC, KCC, e-Standby, Energy Star®, TCO7.0, RoHs, Windows 7/8.1/10 WHQL, Flicker Free, Low Blue Light

*Specifications are subject to change without notice.

**measuring a screen brightness of 200 nits without audio/USB/Card reader connection.

BE209TL/BE209TLB

Panel Type	TFT LCD
Panel size	19.45" (16:10, 49.4 cm) wide
Max. Resolution	1440 x 900
Pixel pitch	0.2907 mm x 0.2915 mm
Brightness (Typ.)	250 cd/m ²
Contrast Ratio (Typ.)	1000:1
Contrast Ratio (Max.)	100,000,000:1 (with ASCR on)
Viewing angle (H/V) CR>10	178°/178°
Display colors	16.7 M
Response time	≤ 5 ms
SplendidPlus Video Enhancement	Yes
SplendidPlus selection	7 video preset modes
Auto adjustment	Yes
Color temperature selection	4 color temperatures
Analog input	D-sub
Digital input	DVI-D with HDCP
Earphone jack	No
Audio input	Yes
Speaker (Built-in)	2 W x 2 Stereo, RMS
USB 2.0 port	Upstream x 1, Downstream x 2 (only for BE209TLB)
Colors	Black
Power LED	White (On)/Amber (Standby)
Tilt	+33° ~ -5°
Pivot	+90° ~ -90°
Swivel	+90° ~ -90°
Height Adjustment	130 mm
Kensington lock	Yes
AC input voltage	AC: 100~240V
Power consumption	Power On: < 15.74 W** (Typ.), Standby: < 0.5 W (Typ.), Power Off: 0 W (Switch off)
Temperature (Operating)	0°C~40°C
Temperature (Non-operating)	-20°C~+60°C
Dimension (W x H x D) with stand	459 x 477 x 211 mm (highest), 459 x 347 x 211 mm (lowest), 621 x 173 x 382 mm (package)
Weight (Esti.)	4.8 kg (Net); 6.4 kg (Gross)
Multi-languages	21 languages (English, French, German, Italian, Spanish, Dutch, Portuguese, Russian, Czech, Croatian, Polish, Romanian, Hungarian, Turkish, Simplified Chinese, Traditional Chinese, Japanese, Korean, Thai, Indonesia, Persian)
Accessories	Power cord, DVI cable, VGA cable, Audio cable, USB cable (only for BE209TLB), Quick start guide, Warranty card

Compliance and Standards

UL/cUL, CB, CE, ErP, FCC, ISO9241-307, RCM, VCCI, RoHS, Windows 7 & 8 WHQL, Energy Star®, EPEAT Gold, TCO 7.0, Flicker Free, Low blue Light, TUV-GS, TUV-Ergo, CU, PSE, WEEE, EMC DoC, UkrSEPRO, MEPS

*Specifications are subject to change without notice.

**measuring a screen brightness of 200 nits without audio/USB/Card reader connection.

3.3 Troubleshooting (FAQ)

Problem	Possible Solution
Power LED is not ON	<ul style="list-style-type: none"> • Press the ⏻ button to check if the monitor is in the ON mode. • Check if the power cord is properly connected to the monitor and the power outlet. • Check if the power switch is ON.
The power LED lights amber and there is no screen image	<ul style="list-style-type: none"> • Check if the monitor and the computer are in the ON mode. • Make sure the signal cable is properly connected the monitor and the computer. • Inspect the signal cable and make sure none of the pins are bent. • Connect the computer with another available monitor to check if the computer is properly working.
Screen image is too light or dark	<ul style="list-style-type: none"> • Adjust the Contrast and Brightness settings via OSD.
Screen image is not centered or sized properly	<ul style="list-style-type: none"> • Adjust the H-Position or V-Position settings via OSD.
Screen image bounces or a wave pattern is present in the image	<ul style="list-style-type: none"> • Make sure the signal cable is properly connected to the monitor and the computer. • Move electrical devices that may cause electrical interference.
Screen image has color defects (white does not look white)	<ul style="list-style-type: none"> • Inspect the signal cable and make sure that none of the pins are bent. • Perform All Reset via OSD. • Adjust the R/G/B color settings or select the Color Temperature via OSD.
Screen image is blurry or fuzzy	<ul style="list-style-type: none"> • Adjust the Phase and Clock settings via OSD.
No sound or sound is low	<ul style="list-style-type: none"> • Ensure that the HDMI/DisplayPort cable is properly connected to the monitor and the computer. • Adjust the volume settings of both your monitor and HDMI/DisplayPort device. • Ensure that the computer sound card driver is properly installed and activated.

3.4 Supported operating modes

BE209

Resolution Frequency	Horizontal Frequency (KHz)	Vertical Frequency (Hz)	Pixel (MHz)
640x480	31.47(N)	59.94(N)	25.18
640x480	35.00(N)	66.66(N)	30.24
640x480	37.87(N)	72.82(N)	31.5
640x480	37.5(N)	75.00(N)	31.5
720x400	31.47(N)	70.08(P)	28.32
800x600	35.16(P)	56.25(P)	36.00
800x600	37.88(P)	60.32(P)	40.00
800x600	48.08(P)	72.12(P)	50.00
800x600	46.86(P)	75.00(P)	49.50
832X624	49.72(P/N)	74.55(P/N)	57.28
1024x768	48.36(N)	60.00(N)	65.00
1024x768	56.476(N)	70.069(N)	75.00
1024x768	60.02(N)	75.00(N)	78.75
1152x864	67.5(P/N)	75.00(P/N)	108
1280x720	45.00(P)	60.00(N)	75.25
1280x768	47.78(P)	60.00(N)	79.5
1280x800	49.7(P)	60.00(N)	83.5
1360x768	47.712(P)	59.79(P)	85.5
1366x768	47.712(P)	59.79(P)	85.5
1440x900	55.94(N)	59.89(P)	106.5

* "P", "N" stands for "Positive", "Negative" polarity of incoming H-sync/V-sync (input timing).

Timing mode :

When the monitor is operating in the video mode (ie, not displaying data) using the HDMI connector, the following high definition modes shall be supported in addition to standard definition video.

Preset	Timing Name	Pixel Format	Horizontal Frequency (kHz)	Vertical Frequency (Hz)	Pixel Rate (MHz)	OSD Display
1	480p	720 x 480	31.469	60	27	480p-60Hz
2	720p60	1280 x 720	45	60	74.25	720p-60Hz
3	576p	720 x 576	31.25	50	27	576p-50Hz
4	720p50	1280 x 720	37.5	50	74.25	720p-50Hz

BE229/BE239/BE249

Resolution Frequency	Horizontal Frequency (KHz)	Vertical Frequency (Hz)	Pixel (MHz)
640x480	31.47(N)	59.94(N)	25.18
640x480	35.00(N)	66.66(N)	30.24
640x480	37.87(N)	72.82(N)	31.5
640x480	37.5(N)	75.00(N)	31.5
720x400	31.47(N)	70.08(P)	28.32
800x600	35.16(P)	56.25(P)	36.00
800x600	37.88(P)	60.32(P)	40.00
800x600	48.08(P)	72.12(P)	50.00
800x600	46.86(P)	75.00(P)	49.50
832x624	49.72(P/N)	74.55(P/N)	57.28
1024x768	48.36(N)	60.00(N)	65.00
1024x768	56.476(N)	70.069(N)	75.00
1024x768	60.02(N)	75.00(N)	78.75
1152x864	67.5(P/N)	75.00(P/N)	108
1280x720	45.00(P)	60.00(N)	75.25
1280x768	47.78(P)	60.00(N)	79.5
1280x800	49.7(P)	60.00(N)	83.5
1280x960	60.00(P)	60.00(N)	108
1280x1024	63.98(P)	60.02(N)	108
1280x1024	79.98(P)	75.02(N)	135
1360x768	47.712(P)	59.79(P)	85.5
1366x768	47.712(P)	59.79(P)	85.5
1440x900	55.94(N)	59.89(P)	106.5
1600x1200	75.00(P)	60.00(P)	162
1680x1050	65.29(P)	60.00(P)	146.25
1920x1080	67.5(P)	60.00(P)	148.5

* "P", "N" stands for "Positive", "Negative" polarity of incoming H-sync/V-sync (input timing).
Timing mode :

When the monitor is operating in the video mode (ie, not displaying data) using the HDMI connector, the following high definition modes shall be supported in addition to standard definition video.

Preset	Timing Name	Pixel Format	Horizontal Frequency (kHz)	Vertical Frequency (Hz)	Pixel Rate (MHz)	OSD Display
1	480p	720 x 480	31.469	60	27	480p-60Hz
2	720p60	1280 x 720	45	60	74.25	720p-60Hz
3	576p	720 x 576	31.25	50	27	576p-50Hz
4	720p50	1280 x 720	37.5	50	74.25	720p-50Hz
5	1080p60	1920 x 1080	67.5	60	148.5	1080p-60Hz
6	1080p50	1920 x 1080	56.25	50	148.5	1080p-50Hz

BE24AQLB

Resolution Frequency	Horizontal Frequency (KHz)	Vertical Frequency (Hz)	Pixel (MHz)
640x480	31.47(N)	59.94(N)	25.18
800x600	35.16(P)	56.25(P)	36
800x600	37.88(P)	60.32(P)	40
1024x768	48.36(N)	60.00(N)	65
1280x960	60.00(P)	60.00(N)	108
1280x1024	63.98(P)	60.02(P)	108
1366x768	47.712(P)	59.79(P)	85.5
1440x900	55.94(N)	59.89(P)	106.5
1600x1200	75.00(P)	60.00(P)	162
1680x1050	65.29(N)	60.00(P)	146.25
1920x1080	67.5(P)	60.00(P)	148.5
1920x1200 (Reduced Blanking)	74.038(P)	59.95(N)	154

* "P" / "N" stands for "Positive" / "Negative" polarity of incoming H-sync/V-sync (input timing).

* Modes not listed in the table may not be supported. For optimal resolution, we recommend that you choose a mode listed in the table above.

* This monitor supports full HD (480p, 576p, 720p, 1080i/p) video content from game consoles, DVD players and other consumer video devices via HDMI.

When the monitor is operating in the video mode (ie, not displaying data), the following high definition modes shall be supported in addition to standard definition video.

Preset	Timing Name	Pixel Format	Horizontal Frequency (kHz)	Vertical Frequency (Hz)	Pixel Rate (MHz)	OSD Display
1	480p	720 x 480	31.469	60	27	480p-60Hz
2	720p60	1280 x 720	45	60	74.25	720p-60Hz
3	576p	720 x 576	31.25	50	27	576p-50Hz
4	720p50	1280 x 720	37.5	50	74.25	720p-50Hz
5	1080p60	1920 x 1080	67.5	60	148.5	1080p-60Hz
6	1080p50	1920 x 1080	56.25	50	148.5	1080p-50Hz

BE24C/BE27A

Resolution	Frequency	Horizontal Frequency (KHz)	Vertical Frequency (Hz)	Pixel (MHz)
640x480		31.47(N)	59.94(N)	25.18
640x480		35.00(N)	66.66(N)	30.24
640x480		37.87(N)	72.82(N)	31.5
640x480		37.5(N)	75.00(N)	31.5
720x400		31.47(N)	70.08(P)	28.32
800x600		35.16(P)	56.25(P)	36.00
800x600		37.88(P)	60.32(P)	40.00
800x600		46.86(P)	75.00(P)	49.50
1024x768		48.36(N)	60.00(N)	65.00
1024x768		56.476(N)	70.069(N)	75.00
1024x768		60.02(N)	75.00(N)	78.75
1152x864		67.5(P/N)	75.00(P/N)	108
1280x720		45.00(P)	60.00(N)	75.25
1280x768		47.78(P)	60.00(N)	79.5
1280x800		49.7(P)	60.00(N)	83.5
1280x960		60.00(P)	60.00(N)	108
1280x1024		63.98(P)	60.02(N)	108
1280x1024		79.98(P)	75.02(N)	135
1366x768		47.712(P)	59.79(P)	85.5
1440x900		55.94(N)	59.89(P)	106.5
1600x1200		75.00(P)	60.00(P)	162
1680x1050		65.29(P)	60.00(P)	146.25
1920x1080		67.5(P)	60.00(P)	148.5
1920x1200 (Reduced Blanking)		74.038(P)	59.95(N)	154
1920x1200		74.556(N)	59.885(P)	193.25
2048x1152 (Reduced Blanking)		70.99(P)	59.9(N)	156.75
2560x1080		66.636(P)	59.978(N)	181.25
2560x1440		88.787(P)	59.951(N)	241.5
2560x1440* (Reduced Blanking)		111.857(P)	74.971(N)	304.25

* Only for BE24C.

** "P" / "N" stands for "Positive" / "Negative" polarity of incoming H-sync/V-sync (input timing).

When the monitor is operating in the video mode (ie, not displaying data), the following high definition modes shall be supported in addition to standard definition video.

Preset	Timing Name	Pixel Format	Horizontal Frequency (kHz)	Vertical Frequency (Hz)	Pixel Rate (MHz)	OSD Display
1	480p	720 x 480	31.469	60	27	480p-60Hz
2	720p60	1280 x 720	45	60	74.25	720p-60Hz
3	576p	720 x 576	31.25	50	27	576p-50Hz
4	720p50	1280 x 720	37.5	50	74.25	720p-50Hz
5	1080p60	1920 x 1080	67.5	60	148.5	1080p-60Hz
6	1080p50	1920 x 1080	56.25	50	148.5	1080p-50Hz