



Operation Manual

Smart-UPS[™] Uninterruptible Power Supply

750/1000/1500/2200/3000 VA
100/120/230 Vac

500 VA
100 Vac

Tower

Important Safety Messages

SAVE THESE INSTRUCTIONS - This manual contains important instructions that should be followed during installation and maintenance of the Power Management Unit, Service Bypass Unit and batteries.

Read the instructions carefully and look at the equipment to become familiar with the device before trying to install, operate, service or maintain it. The following special messages may appear throughout this document or on the equipment to warn of potential hazards or to call attention to information that clarifies or simplifies a procedure.



The addition of this symbol to a Danger or Warning product safety label indicates that an electrical hazard exists that will result in personal injury if the instructions are not followed.



This is the safety alert symbol. It is used to alert you to potential personal injury hazards. Obey all safety messages that follow this symbol to avoid possible injury or death.

DANGER

DANGER indicates a hazardous situation which, if not avoided, will result in death or serious injury.

WARNING

WARNING indicates a hazardous situation which, if not avoided, could result in death or serious injury.

CAUTION

CAUTION indicates a hazardous situation which, if not avoided, could result in minor or moderate injury.

NOTICE

NOTICE is used to address practices not related to physical injury.

Product Handling Guidelines

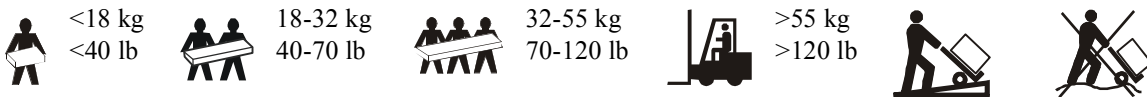

Safety and General Information

Inspect the package contents upon receipt.

Notify the carrier and dealer if there is any damage.

- Adhere to all national and local electrical codes.
- All wiring must be performed by a qualified electrician.
- Changes and modifications to this unit not expressly approved by Schneider Electric could void the warranty.
- This UPS is intended for indoor use only.

- Do not operate this unit in direct sunlight, in contact with fluids, or where there is excessive dust or humidity.
- Be sure the air vents on the UPS are not blocked. Allow adequate space for proper ventilation.
- The equipment is heavy. Always practice safe lifting techniques adequate for the weight of the equipment.

Battery safety

- It is not necessary to ground the battery system. The user has the option of referencing the battery system to chassis ground at either a positive or negative battery terminal.
- When replacing batteries, replace with the same number and type.
- Batteries typically last for two to five years. Environmental factors impact battery life. Elevated ambient temperatures, poor quality utility power, and frequent short duration discharges will shorten battery life. Batteries should be replaced before end of life.
- Replace batteries immediately when the unit indicates battery replacement is necessary.
- Schneider Electric uses Maintenance-Free sealed Lead Acid batteries. Under normal use and handling, there is no contact with the internal components of the battery. Over charging, over heating or other misuse of batteries can result in a discharge of battery electrolyte. Released electrolyte is toxic and may be harmful to the skin and eyes.
- CAUTION: Before installing or replacing the batteries, remove jewelry such as wristwatches and rings.
High short circuit current through conductive materials could cause severe burns.
- CAUTION: Do not dispose of batteries in a fire. The batteries may explode.
- CAUTION: Do not open or mutilate batteries. Released material is harmful to the skin and eyes and may be toxic.

Deenergizing safety

The UPS contains internal batteries and may present a shock hazard even when disconnected from the branch circuit (mains). Before installing or servicing the equipment check that the:

- Input circuit breaker is in the **OFF** position.
- Internal UPS batteries are removed.

FCC Warning

This equipment has been tested and found to comply with the limits for a Class A digital device, pursuant to part 15 of the FCC Rules. These limits are designed to provide reasonable protection against harmful interference when the equipment is operated in a commercial environment. This equipment generates, uses, and can radiate radio frequency energy and, if not installed and used in accordance with the instruction manual, may cause harmful interference to radio communications. Operation of this equipment in a residential area is likely to cause harmful interference in which case the user will be required to correct the interference at his own expense.

Product Description

The APC™ by Schneider Electric Smart-UPS™ is a high performance uninterruptible power supply (UPS). The UPS provides protection for electronic equipment from utility power blackouts, brownouts, sags, and surges, small utility power fluctuations and large disturbances. The UPS also provides battery backup power for connected equipment until utility power returns to acceptable levels or the batteries are fully discharged.

This user manual is available on the enclosed CD and on the APC by Schneider Electric web site, www.apc.com.

Specifications

For additional specifications, refer to the APC by Schneider Electric web site at www.apc.com.

Environmental

Temperature	Operating	0° to 40° C (32° to 104° F)
	Storage	-15° to 45° C (5° to 113° F) charge UPS battery every six months
Maximum Elevation	Operating	3,000 m (10,000 ft)
	Storage	15,000 m (50,000 ft)
Humidity	0% to 95% relative humidity, non-condensing	

Product Overview

Front panel features

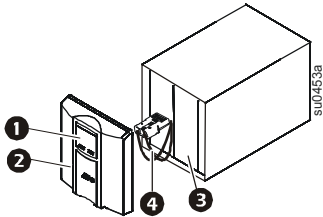
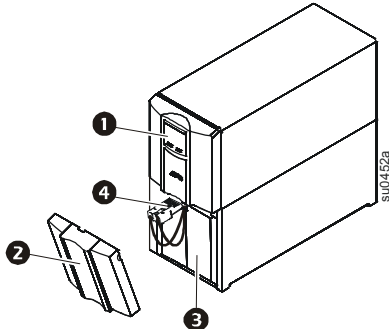
		500/750/1000/1500 VA	2200/3000 VA
❶	Display interface		
❷	Bezel		
❸	Battery		
❹	Internal battery connector		

Rear panel features 500 VA to 1500 VA models

- ❶ USB port
- ❷ Serial port
- ❸ Chassis ground screw
- ❹ SmartSlot
- ❺ Circuit breaker
- ❻ UPS input
- ❼ Outlets
- ❽ Internal or external battery connector

500/750 VA 100 Vac
750 VA 120 Vac

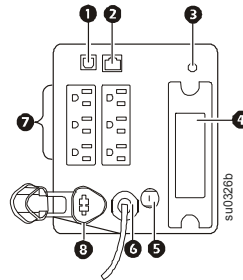

750 VA 230 Vac

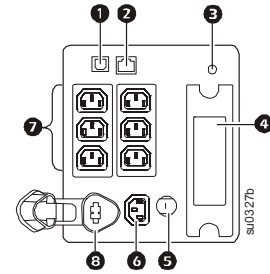

1000/1500 VA 100 Vac
1000/1500 VA 120 Vac

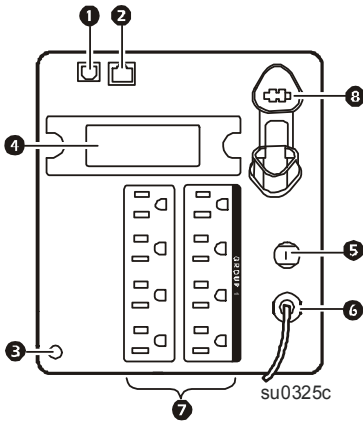

1000/1500 VA 230 Vac

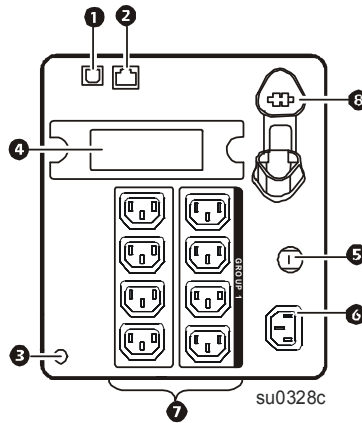

Rear panel features 2200 VA and 3000 VA models

- ❶ USB Port
- ❷ Serial port
- ❸ Chassis ground screw
- ❹ SmartSlot
- ❺ Circuit breaker
- ❻ UPS input
- ❼ Outlets
- ❽ EPO connector

2200 VA 120 Vac

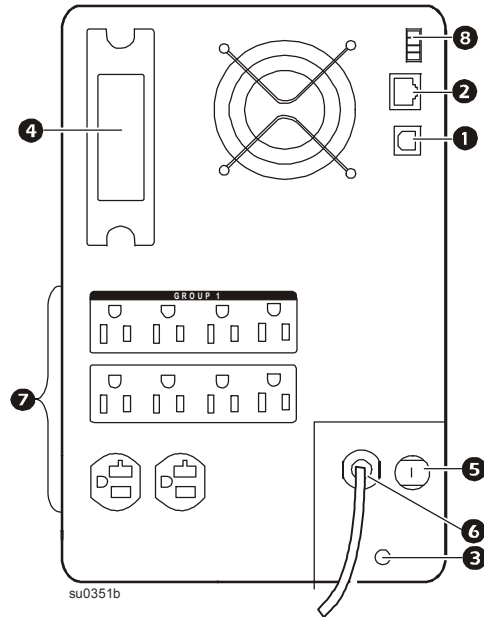

2200/3000 VA 100 Vac
3000 VA 120 Vac

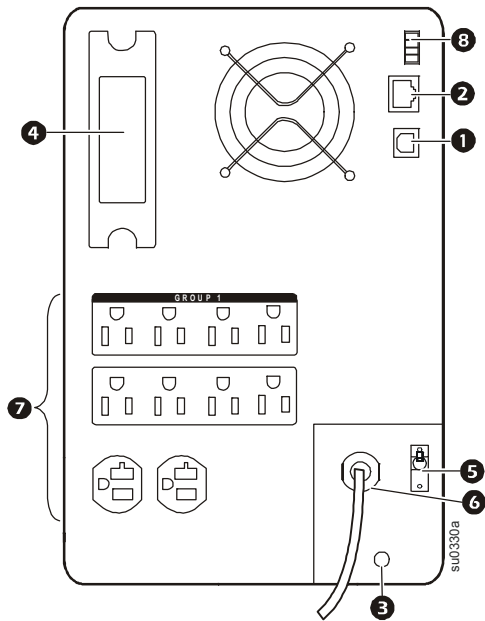

2200/3000 VA 230 Vac

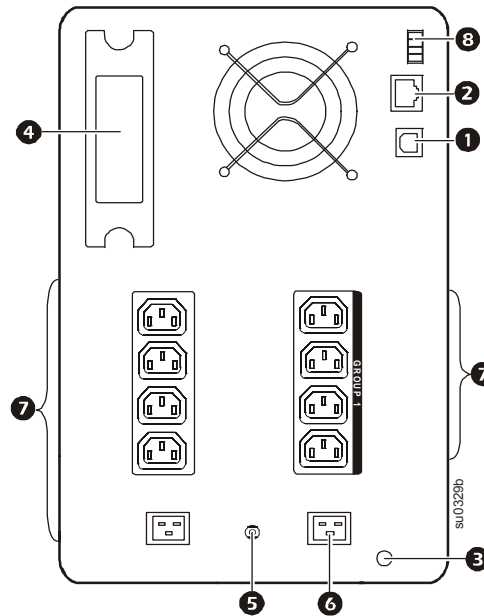

Installation

For UPS installation information, refer to the Smart-UPS Installation Guide 750/1000/1500/2200/3000 VA 100/120/230 Vac, 500 VA 100 Vac Tower, that is included with the UPS. The Installation guide is also available on the Documentation CD included with the UPS and on the APC by Schneider Electric web site, www.apc.com.

Operation

Connect Equipment

⚠ CAUTION

RISK OF ELECTRIC SHOCK

- Adhere to all local and national electrical codes.
- Wiring must be performed by qualified electrician.
- Always connect the UPS to a grounded outlet.

Failure to follow these instructions could result in minor or moderate injury.

Note: The 2200/3000 VA 100 Vac model UPS will charge to 90% capacity in the first four and a half hours of normal operation.

All other models will charge to 90% capacity in the first three hours of normal operation

Do not expect full battery runtime capability during this initial charge period.

1. Connect equipment to the outlets on the rear panel of the UPS.
2. Connect the UPS to the building utility power.
Always connect the UPS to a two pole, three wire, grounded source.
3. To use the UPS as a master ON/OFF switch, turn on all the equipment that is connected to the UPS.
4. Press the ON/OFF button on the front panel of the UPS to turn on the UPS and all connected equipment.
See “Main Outlet Group and Controlled Outlet Group” on page 11 for information on how to configure the outlet groups.

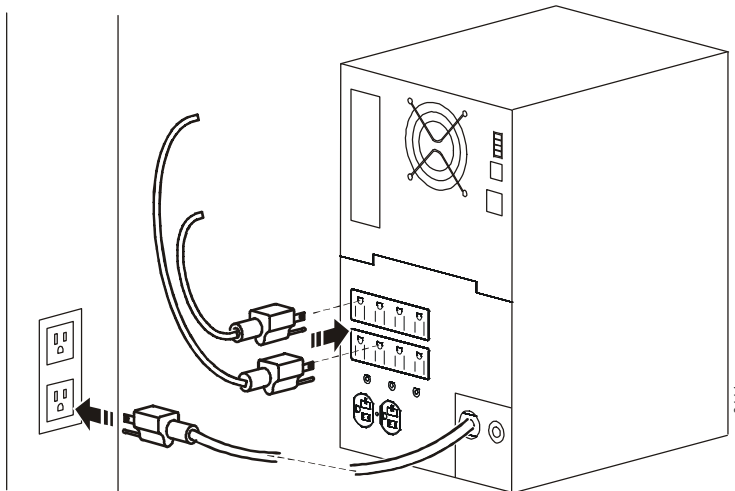

Rear Panel Features



Serial port: Connect to a computer to use power management software.



USB port: Connect to a computer to use power management software.

Note: Serial and USB communication can not be used simultaneously.



Ground Screw: The UPS features a ground screw for connecting the ground leads on transient voltage devices. Prior to connecting a ground lead, disconnect the UPS from utility power.

Display Panel

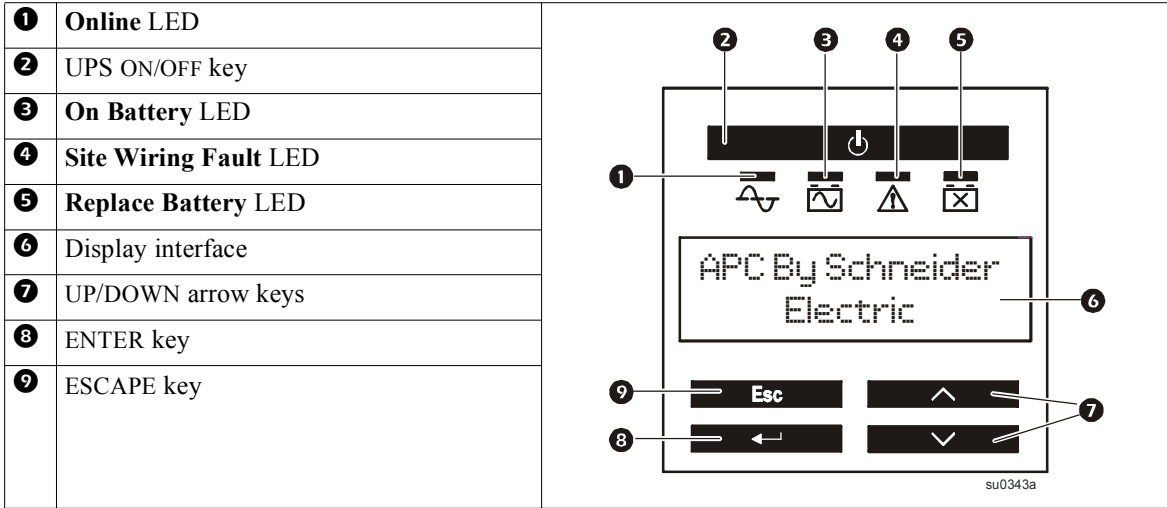

Using the display interface

Use the UP/DOWN arrow buttons to scroll through the main menu options. Press ENTER to view the submenus under each main menu option. Press ESCAPE to exit a submenu and return to a main menu.

Standard menus

The Standard menus are the most commonly used menus.

Menu	General Functions	
Status	View UPS information:	
	<ul style="list-style-type: none"> • Operating Mode • Efficiency • Load Power • Load VA • Battery Charge state • Estimated Runtime 	<ul style="list-style-type: none"> • Battery Temp • Input • Output • Last Transfer • Last UPS Self Test
Configuration	Configure UPS settings:	
	<ul style="list-style-type: none"> • Language • Local Power Quality: Good, Fair, Poor • Menu Type: Standard or Advanced • Audible Alarm 	<ul style="list-style-type: none"> • Display (Auto Dim, Auto Off, Always On) • Battery Install Date • Reset to Factory Default
Test & Diags	Perform UPS tests and diagnostic functions:	
	<ul style="list-style-type: none"> • UPS Self Test • UPS Alarms Test • Calibration Test 	
About	View UPS information:	
	<ul style="list-style-type: none"> • UPS Model • UPS Part No. • UPS Serial No. • UPS Manufacture Date 	<ul style="list-style-type: none"> • Battery Part No. • Battery Install Date • Replace Battery by • UPS Firmware 1

Advanced menus

The Advanced menus provide additional options for the UPS and are available only if the display interface is configured to use the Advanced menus.

Menu	General Functions	
Status	View detailed UPS information:	
	<ul style="list-style-type: none"> • Operating Mode • Efficiency • Load Power • Load VA • Load Amps • Load Energy • Battery Charge state • Estimated Runtime • Battery Voltage 	<ul style="list-style-type: none"> • Battery Temp • Input • Output • Last Transfer • Last UPS Self Test • Outlet Group 1 (if Controlled Outlet is available) • NMC IP Address (if NMC is available)
Configuration	Configure advanced UPS settings:	
	<ul style="list-style-type: none"> • Language • Local Power Quality • Menu Type • Audible Alarm • Display (Auto Dim, Auto Off, Always On) • Sensitivity • Low Transfer • High Transfer • Low Battery Alert • Auto Self Test 	<ul style="list-style-type: none"> • Battery Install Date • Reset Energy Meter • Enter Setup Wizard • Firmware Update (standby mode) • Reset to Factory Default • Config Main Group Outlets • Config Group 1 Outlets (if Controlled Outlet is available) • Config NMC (if NMC is available)
Control	Control the Main and Switched Outlet Group to turn on, turn off, shutdown, or reboot.	
Test & Diags	Perform UPS test and diagnostic functions:	
	<ul style="list-style-type: none"> • UPS Self Test • UPS Alarms Test • Calibration Test 	
Log	View the event and logs for information about UPS events that have occurred.	
About	View UPS information:	
	<ul style="list-style-type: none"> • UPS Model • UPS Part No. • UPS Serial No. • UPS Manufacture Date • Battery Part No. • Battery Install Date • Replace Battery by • UPS Firmware 1 • UPS Firmware 2 • UPS Firmware 3 • UPS Firmware 4 	<ul style="list-style-type: none"> • NMC Model No.* • NMC Serial No.* • NMC Hardware Version* • NMC Manufacture Date* • NMC MAC Address* • SmartSlot FW 1* • SmartSlot FW 2* • SmartSlot FW 3* <p>*If NMC is available</p>

Configuration

UPS Settings

Start up Settings

Configure these settings at initial start up, using the display interface. As an alternative, configuration can be performed using PowerChute™ software.

Note: During start up, use the display interface to configure these settings. If nothing is selected, the unit will use the default settings.

Function	Factory Default	Options	Description
Language	English	<ul style="list-style-type: none"> • English • French* • German* • Spanish* • Italian* • Portuguese* • Japanese* 	<p>The language for the display interface.</p> <p>*Language options will vary by model.</p>
Local Power Quality	Good	<ul style="list-style-type: none"> • Good • Fair • Poor 	<p>Select the quality of input utility power.</p> <ul style="list-style-type: none"> • If Good is selected, the unit will go on battery power more often to provide the cleanest power supply to the connected equipment. • If Poor is selected, the UPS will tolerate more fluctuations in power and will go on battery power less often. <p>If unsure of the local power quality, select Good.</p>
Menu Type	Standard	Standard or Advanced	The Standard menus display a limited set of menus and options. The advanced menus include all parameters.

General Settings

Configure these settings at any time. Use the display interface or PowerChute software.

Function	Factory Default	Options	Description
High Transfer Point	100 Vac: 108 Vac	108 Vac - 114 Vac	<p>To avoid unnecessary battery usage, set the transfer point higher if the utility voltage is chronically high and the connected equipment is known to work under this condition. The Power Quality setting will automatically change this setting.</p> <p>Note: Use the Advanced Menus to configure this setting.</p>
	120 Vac: 127 Vac	127 Vac - 136 Vac	
	230 Vac: 253 Vac	253 Vac - 265 Vac	
Low Transfer Point	100 Vac: 92 Vac	86 Vac - 92 Vac	<p>Set the transfer point lower if the utility voltage is chronically low and the connected equipment can tolerate this condition. This setting may also be adjusted using the power quality setting.</p> <p>Note: Use the Advanced Menus to configure this setting.</p>
	120 Vac: 106 Vac	97 Vac - 106 Vac	
	230 Vac: 208 Vac	196 Vac - 208 Vac	

Function	Factory Default	Options	Description
Nominal Output Voltage	100 Vac	N/A	230 Vac models only: Set the nominal output voltage of the UPS to standby mode.
	120 Vac	N/A	
	230 Vac	<ul style="list-style-type: none"> • 220 Vac • 230 Vac • 240 Vac 	
Transfer Sensitivity	Normal	Normal, Reduced, Low	<p>Select the level of sensitivity to power events that the UPS will tolerate.</p> <ul style="list-style-type: none"> • Normal: The UPS will go on battery power more often to provide the cleanest power supply to the connected equipment. • Low: The UPS will tolerate more fluctuations in power and will go on battery power less often. <p>If the connected load is sensitive to power disturbances, set the sensitivity to Normal.</p>
Low Battery Alert	120 sec	Set the value in seconds	The UPS will emit an audible alarm when the remaining runtime has reached this level.
Date of Last Battery Replacement	Date set at factory	Reset this date when the battery module is replaced.	
Audible Alarm	On	On/Off	The UPS will mute all audible alarms if this is set to Off or when the display keys are pressed.
Battery Self-Test Interval Setting	On start up and every 14 days since the last test	<ul style="list-style-type: none"> • Never • Start up only • Frequency of test (every 7 to 14 days) 	The interval at which the UPS will execute a self-test.
Reset to Factory Default	No	Yes/No	Restore the UPS factory default settings.

Main Outlet Group and Controlled Outlet Group

Overview

The Main Outlet Group and the Controlled Outlet Group can be configured to independently turn off, turn on, shut down, and reboot connected equipment. (These features are not available on the 500 VA or 750 VA units.)

The Main and Controlled Outlet Groups can be configured to do the following:

- Turn off: Disconnect from power immediately and restart only with a manual command.
- Turn on: Connect to power immediately.
- Shutdown: Disconnect power in sequence, and automatically reapply power in sequence when utility power becomes available.
- Reboot: Shut down and restart.

In addition, the Main Outlet Group and the Controlled Outlet Group can be configured to do the following:

- Turn on or off in a specified sequence
- Automatically turn off or shut down when various conditions occur

Note: If the Main and Controlled Outlet Groups are not configured, all of the outlets on the unit will still provide battery backup power.

Using the Main and Controlled Outlet Groups

The Main Outlet Group functions as a master switch. It will turn on first when power is applied, and shut down last when there is a power outage and battery runtime has been exhausted.

The Main Outlet Group must be turned on for the Controlled Outlet Group to turn on.

1. Connect critical equipment to the Main Outlet Group.
2. Connect peripheral equipment to the Controlled Outlet Group.
 - Nonessential equipment that should shut down quickly in the event of a power outage can be added to a short power off delay, to conserve battery runtime.
 - Equipment that has dependent peripherals that must restart or shut down in a specific order should be connected to a separate outlet group.
 - Equipment that needs to reboot independently from other equipment should be added to a separate outlet group.
3. Use the **Configuration** menus to set reaction of the Controlled Outlet Group in the event of a power outage.

Customize the Main and Controlled Outlet Groups

Use the **Configuration** menus to change the Main Outlet Group and the Controlled Outlet Group settings.

Function	Factory Default	Options	Description
Name String Outlet Group	Outlet Group 1	Edit these names using an external interface, such as the Network Management Card web interface.	
UPS Name String	UPS Outlets		
Turn On Delay	0 sec	Set the value in seconds	The amount of time the UPS or a Controlled Outlet Group will wait between receiving the command to turn on and the actual startup.
Turn Off Delay	<ul style="list-style-type: none"> • 0 sec UPS Outlets • 90 sec Controlled Outlet Groups 	Set the value in seconds	The amount of time the UPS or a Controlled Outlet Group will wait between receiving the command to turn off and the actual shut down.
Reboot Duration	8 sec	Set the value in seconds	The amount of time the UPS or a Controlled Outlet Group must remain off before it will restart.
Minimum Return Time	0 sec	Set the value in seconds	The amount of battery runtime that must be available before the UPS or a Controlled Outlet Group will turn on after a shutdown.
Load Shed On Battery	Disabled	<ul style="list-style-type: none"> • Enable • Disable 	<p>When the unit switches to battery power, the UPS will disconnect power to the Controlled Outlet Group to save battery runtime.</p> <p>Configure this delay time, use the LOAD SHED TIME WHEN ON BATTERY setting.</p>
Load Shed Time when On Battery	1800 sec	Set the value in seconds	The amount of time the outlets will function on battery power before they will turn off.
Load Shed On Runtime	Disabled	<ul style="list-style-type: none"> • Enable • Disable 	<p>When the battery runtime falls below the specified value, the Controlled Outlet Group will turn off.</p> <p>Configure this time using the LOAD SHED RUNTIME REMAINING setting.</p>
Load Shed On Runtime Remaining	120 sec	Set the value in seconds	When the remaining runtime reaches this level, the Controlled Outlet Group will turn off.
Load Shed on Overload	Disabled	<ul style="list-style-type: none"> • Disabled • Enabled 	In the event of an overload (greater than 107% output), the Controlled Outlet Group will immediately turn off to conserve power for critical loads. The Controlled Outlet Group will only turn on again with a manual command.

Network Management Card Settings

These settings are available only on units that have a Network Management Card (NMC) and are set at the factory. These settings can only be modified using an external interface, such as the NMC web interface.

- NMC IP Address Mode
- NMC IP Address
- NMC Subnet Mask
- NMC Default Gateway

Emergency Power Off

Overview

The Emergency Power Off (EPO) option, is a feature that will immediately disconnect all connected equipment from utility power. The UPS will immediately shut down and will not switch to battery power.

Connect each UPS to the EPO switch. In configurations where multiple units are connected in parallel, each UPS must be connected to the EPO switch.

The UPS should be restarted for power to return to connected equipment. Press the ON/OFF key on the front panel of the UPS.

CAUTION

RISK OF ELECTRIC SHOCK

- Adhere to all local and national electrical codes.
- Wiring must be performed by qualified electrician.
- Always connect the UPS to a grounded outlet.

Failure to follow these instructions could result in minor or moderate injury.

Normally open contacts

1. If the EPO switch or relay contacts are normally open, insert the wires from the switch or contacts at pins 1 and 2 of the EPO terminal block. Use 16-28 AWG wire.
2. Secure the wires by tightening the screws.

If the contacts are closed, the UPS will turn OFF and power will be removed from the load.

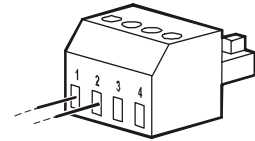

Normally closed contacts

1. If the EPO switch or relay contacts are normally closed, insert the wires from the switch or contacts at pins 2 and 3 of the EPO terminal block. Use 16-28 AWG wire.
2. Insert a wire jumper between pins 1 and 2. Secure the wires by tightening the three screws at positions 1, 2, and 3.

If the contacts are opened, the UPS will turn OFF and power will be removed from the load.

Note: Pin 1 is the power source for the EPO circuit, it provides a few milliamperes of 24 V power.

If the normally closed (NC) EPO configuration is used, the EPO switch or relay should be rated for “dry” circuit applications, the rating should be for low voltage and low current applications. This normally implies the contacts are gold-plated.

The EPO interface is a Safety Extra Low Voltage (SELV) circuit. Connect the EPO interface only to other SELV circuits. The EPO interface monitors circuits that have no determined voltage potential. SELV circuits are controlled by a switch or relay properly isolated from utility power. To avoid damage to the UPS, do not connect the EPO interface to any circuit other than a SELV circuit.

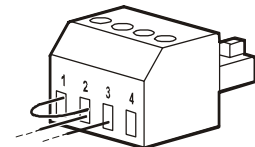

Use one of the following cable types to connect the UPS to the EPO switch.

- CL2: Class 2 cable for general use.
- CL2P: Plenum cable for use in ducts, plenums, and other spaces used for environmental air.
- CL2R: Riser cable for use in a vertical run in a floor-to-floor shaft.
- CLEX: Limited use cable for use in dwellings and for use in raceways.
- Installation in Canada: Use only CSA certified, type ELC, (extra-low voltage control cable).
- Installation in countries other than Canada and the USA: Use standard low voltage cable in accordance with national and local regulations.

Note: The EPO function is available only for 2200/3000VA models.

Troubleshooting

Problem and Possible Cause	Solution
The UPS will not turn on or there is no output	
The unit has not been turned on.	Press the ON key once to turn on the UPS.
The UPS is not connected to utility power.	Be sure the power cable is securely connected to the unit and to the utility power supply.
The input circuit breaker has tripped.	Reduce the load on the UPS. Disconnect nonessential equipment and reset the circuit breaker.
The unit shows very low or no input utility voltage.	Check the utility power supply to the UPS by plugging in a table lamp. If the light is very dim, check the utility voltage.
The battery connector plug is not securely connected.	Be sure that all battery connections are secure.
The UPS has detected an internal fault.	Do not attempt to use the UPS. Unplug the UPS and have it serviced immediately.
The UPS is operating on battery, while connected to utility power	
The input circuit breaker has tripped.	Reduce the load on the UPS. Disconnect nonessential equipment and reset the circuit breaker.
There is very high, very low, or distorted input line voltage.	Move the UPS to a different outlet on a different circuit. Test the input voltage with the utility voltage display. If acceptable to the connected equipment, reduce the UPS sensitivity.
UPS is emits intermittent beeps	
The UPS is operating normally.	None. The UPS is protecting the connected equipment.
UPS does not provide expected backup time	
The UPS battery is weak due to a recent power outage or is near the end of its service life.	Charge the battery. Batteries require recharging after extended outages and wear out faster when put into service often or when operated at elevated temperatures. If the battery is near the end of its service life, consider replacing the battery even if the replace battery indicator has not illuminated.
The UPS is experiencing an overload condition.	Check the UPS load display. Unplug unnecessary equipment, such as printers.
Display interface LEDs flash sequentially	
The UPS has been shut down remotely through software or an optional accessory card.	None. The UPS will restart automatically when utility power is restored.
The Alert LED is illuminated The UPS displays an alert message and emits a constant beeping sound	
The UPS has detected an internal fault.	Do not attempt to use the UPS. Turn the UPS off and have it serviced immediately.

Problem and Possible Cause	Solution
The Replace Battery LED is illuminated and the UPS beeps for one minute every five hours	
The battery has a weak charge.	Allow the battery to recharge for at least four hours. Then, perform a self-test. If the problem persists after recharging, replace the battery.
The Replace Battery LED is flashing and the UPS beeps once every 2 seconds	
The replacement battery is not properly connected.	Be sure that the battery connector is securely connected.
The UPS displays a site wiring fault message	
Wiring faults detected include missing ground, hot-neutral, polarity reversal, and overloaded neutral circuit.	If the UPS indicates a site wiring fault, have a qualified electrician inspect the building wiring. (Applicable for 120 V units only.)

Service

If the unit requires service, do not return it to the dealer. Follow these steps:

1. Review the *Troubleshooting* section of the manual to eliminate common problems.
2. If the problem persists, contact APC by Schneider Electric Customer Support through the APC by Schneider Electric web site, **www.apc.com**.
 - a. Note the model number and serial number and the date of purchase. The model and serial numbers are located on the rear panel of the unit and are available through the LCD display on select models.
 - b. Call APC by Schneider Electric Customer Support and a technician will attempt to solve the problem over the phone. If this is not possible, the technician will issue a Returned Material Authorization Number (RMA#).
 - c. If the unit is under warranty, the repairs are free.
 - d. Service procedures and returns may vary internationally. Refer to the APC by Schneider Electric web site for country specific instructions.
3. Pack the unit in the original packaging whenever possible to avoid damage in transit. Never use foam beads for packaging. Damage sustained in transit is not covered under warranty.
 - a. **Always DISCONNECT THE UPS BATTERIES before shipping. The United States Department of Transportation (DOT), and the International Air Transport Association (IATA) regulations require that UPS batteries be disconnected before shipping.** The internal batteries may remain in the UPS.
 - b. External Battery Pack products are deenergized when disconnected from the associated UPS product. It is not necessary to disconnect the internal batteries for shipping. Not all units utilize an external battery pack.
4. Write the RMA# provided by Customer Support on the outside of the package.
5. Return the unit by insured, prepaid carrier to the address provided by Customer Support.

Transport the unit

1. Shut down and disconnect all connected equipment.
2. Disconnect the unit from utility power.
3. Disconnect all internal and external batteries (if applicable).
4. Follow the shipping instructions outlined in the *Service* section of this manual.

Limited Factory Warranty

Schneider Electric IT Corporation (SEIT), warrants its products to be free from defects in materials and workmanship for a period of three (3) years excluding the batteries, which are warranted for two (2) years from the date of purchase. The SEIT obligation under this warranty is limited to repairing or replacing, at its own sole option, any such defective products. Repair or replacement of a defective product or parts thereof does not extend the original warranty period.

This warranty applies only to the original purchaser who must have properly registered the product within 10 days of purchase. Products may be registered online at warranty.apc.com.

SEIT shall not be liable under the warranty if its testing and examination disclose that the alleged defect in the product does not exist or was caused by end user's or any third person's misuse, negligence, improper installation, testing, operation or use of the product contrary to SEIT's recommendations or specifications. Further, SEIT shall not be liable for defects resulting from: 1) unauthorized attempts to repair or modify the product, 2) incorrect or inadequate electrical voltage or connection, 3) inappropriate on site operation conditions, 4) Acts of God, 5) exposure to the elements, or 6) theft. In no event shall SEIT have any liability under this warranty for any product where the serial number has been altered, defaced, or removed.

EXCEPT AS SET FORTH ABOVE, THERE ARE NO WARRANTIES, EXPRESS OR IMPLIED, BY OPERATION OF LAW OR OTHERWISE, APPLICABLE TO PRODUCTS SOLD, SERVICED OR FURNISHED UNDER THIS AGREEMENT OR IN CONNECTION HEREWITH.

SEIT DISCLAIMS ALL IMPLIED WARRANTIES OF MERCHANTABILITY, SATISFACTION AND FITNESS FOR A PARTICULAR PURPOSE.

SEIT EXPRESS WARRANTIES WILL NOT BE ENLARGED, DIMINISHED, OR AFFECTED BY AND NO OBLIGATION OR LIABILITY WILL ARISE OUT OF, SEIT'S RENDERING OF TECHNICAL OR OTHER ADVICE OR SERVICE IN CONNECTION WITH THE PRODUCTS.

THE FOREGOING WARRANTIES AND REMEDIES ARE EXCLUSIVE AND IN LIEU OF ALL OTHER WARRANTIES AND REMEDIES. THE WARRANTIES SET FORTH ABOVE CONSTITUTE SEIT'S SOLE LIABILITY AND PURCHASER'S EXCLUSIVE REMEDY FOR ANY BREACH OF SUCH WARRANTIES. SEIT WARRANTIES EXTEND ONLY TO ORIGINAL PURCHASER AND ARE NOT EXTENDED TO ANY THIRD PARTIES.

IN NO EVENT SHALL SEIT, ITS OFFICERS, DIRECTORS, AFFILIATES OR EMPLOYEES BE LIABLE FOR ANY FORM OF INDIRECT, SPECIAL, CONSEQUENTIAL OR PUNITIVE DAMAGES, ARISING OUT OF THE USE, SERVICE OR INSTALLATION OF THE PRODUCTS, WHETHER SUCH DAMAGES ARISE IN CONTRACT OR TORT, IRRESPECTIVE OF FAULT, NEGLIGENCE OR STRICT LIABILITY OR WHETHER SEIT HAS BEEN ADVISED IN ADVANCE OF THE POSSIBILITY OF SUCH DAMAGES. SPECIFICALLY, SEIT IS NOT LIABLE FOR ANY COSTS, SUCH AS LOST PROFITS OR REVENUE, WHETHER DIRECT OR INDIRECT, LOSS OF EQUIPMENT, LOSS OF USE OF EQUIPMENT, LOSS OF SOFTWARE, LOSS OF DATA, COSTS OF SUBSTITUANTS, CLAIMS BY THIRD PARTIES, OR OTHERWISE.

NOTHING IN THIS LIMITED WARRANTY SHALL SEEK TO EXCLUDE OR LIMIT SEIT'S LIABILITY FOR DEATH OR PERSONAL INJURY RESULTING FROM ITS NEGLIGENCE OR ITS FRAUDULENT MISREPRESENTATION OF TO THE EXTENT THAT IT CANNOT BE EXCLUDED OR LIMITED BY APPLICABLE LAW.

To obtain service under warranty you must obtain a Returned Material Authorization (RMA) number from customer support. Customers with warranty claims issues may access the SEIT worldwide customer support network through the SEIT Web site: www.apc.com. Select your country from the country selection drop down menu. Open the Support tab at the top of the web page to obtain information for customer support in your region. Products must be returned with transportation charges prepaid and must be accompanied by a brief description of the problem encountered and proof of date and place of purchase.

APC™ by Schneider Electric Worldwide Customer Support

Customer support for this or any other APC™ by Schneider Electric product is available at no charge in any of the following ways:

- Visit the APC by Schneider Electric web site, www.apc.com to access documents in the APC Knowledge Base and to submit customer support requests.
 - **www.apc.com** (Corporate Headquarters)
Connect to localized APC by Schneider Electric web site for specific countries, each of which provides customer support information.
 - **www.apc.com/support/**
Global support searching APC Knowledge Base and using e-support.
- Contact the APC by Schneider Electric Customer Support Center by telephone or e-mail.
 - Local, country specific centers: go to **www.apc.com/support/contact** for contact information.
 - For information on how to obtain local customer support, contact the APC by Schneider Electric representative or other distributor from whom you purchased your APC by Schneider Electric product.

© 2018 APC by Schneider Electric. APC, the APC logo, Smart-UPS and PowerChute are owned by Schneider Electric Industries S.A.S. or their affiliated companies. All other trademarks are property of their respective owners.