

Acer LCD Monitor

User's Guide

Copyright © 2014. Acer Incorporated.
All Rights Reserved.

Acer LCD Monitor User's Guide
Original Issue: 12/2014

Changes may be made periodically to the information in this publication without obligation to notify any person of such revisions or changes. Such changes will be incorporated in new editions of this manual or supplementary documents and publications. This company makes no representations or warranties, either expressed or implied, with respect to the contents hereof and specifically disclaims the implied warranties of merchantability or fitness for a particular purpose.

Record the model number, serial number, purchase date and place of purchase information in the space provided below. The serial number and model number are recorded on the label affixed to your computer. All correspondence concerning your unit should include the serial number, model number and purchase information.

No part of this publication may be reproduced, stored in a retrieval system, or transmitted, in any form or by any means, electronically, mechanically, by photocopy, recording or otherwise, without the prior written permission of Acer Incorporated.

Acer LCD Monitor User's Guide

Model number: _____

Serial number: _____

Date of purchase: _____

Place of purchase: _____

Acer and the Acer logo are registered trademarks of Acer Incorporated. Other companies' product names or trademarks are used herein for identification purposes only and belong to their respective companies.

Special notes on LCD monitors

The following are normal with the LCD monitor and do not indicate a problem.

- Due to the nature of the fluorescent light, the screen may flicker during initial use. Turn off the power switch and then turn it on again to make sure the flicker disappears.
- You may find slightly uneven brightness on the screen depending on the desktop pattern you use.
- The LCD screen has 99.99% or more effective pixels. It may include blemishes of 0.01% or less such as a missing pixel or a pixel lit all the time.
- Due to the nature of the LCD screen, an afterimage of the previous screen may remain after switching the image, when the same image is displayed for hours. In this case, the screen is recovered slowly by changing the image or turning off the power switch for a few hours.

Information for your safety and comfort

Safety instructions

Read these instructions carefully. Keep this document for future reference. Follow all warnings and instructions marked on the product.

Cleaning your monitor

Please carefully follow these guidelines when cleaning the monitor:

- Always unplug the monitor before cleaning.
- Use a soft cloth to wipe the screen and cabinet front and sides.

Connecting/disconnecting the device

Observe the following guidelines when connecting and disconnecting power from the LCD monitor:

- Make sure the monitor is attached to its base before connecting the power cord to the AC power outlet.
- Make sure both the LCD monitor and the computer are turned off before connecting any cable or unplugging the power cord.
- If the system has multiple sources of power, disconnect power from the system by unplugging all power cords from the power supplies.

Accessibility

Be sure that the power outlet you plug the power cord into is easily accessible and located as close to the equipment operator as possible. When you need to disconnect power from the equipment, be sure to unplug the power cord from the electrical outlet.

Safe listening

To protect your hearing, follow these instructions.

- Gradually increase the volume until you can hear it clearly and comfortably and without distortion.
- After setting the volume level, do not increase it after your ears have adjusted.
- Limit the amount of time listening to music at high volume.
- Avoid turning up the volume to block out noisy surroundings.
- Turn the volume down if you can't hear people speaking near you.

Warnings

- Do not use this product near water.
- Do not place this product on an unstable cart, stand or table. If the product falls, it could be seriously damaged.
- Slots and openings are provided for ventilation to ensure reliable operation of the product and to protect it from overheating. These openings must not be blocked or covered. The openings should never be blocked by placing the product on a bed, sofa, rug or other similar surface. This product should never be placed near or over a radiator or heat register, or in a built-in installation unless proper ventilation is provided.
- Never push objects of any kind into this product through cabinet slots as they may touch dangerous voltage points or short-out parts that could result in a fire or electric shock. Never spill liquid of any kind onto or into the product.
- To avoid damage of internal components and to prevent battery leakage, do not place the product on a vibrating surface.
- Never use it under sporting, exercising, or any vibrating environment which will probably cause unexpected short current or damage internal devices.

Using electrical power

- This product should be operated from the type of power indicated on the marking label. If you are not sure of the type of power available, consult your dealer or local power company.
- Do not allow anything to rest on the power cord. Do not locate this product where people will walk on the cord.
- If an extension cord is used with this product, make sure that the total

ampere rating of the equipment plugged into the extension cord does not exceed the extension cord ampere rating. Also, make sure that the total rating of all products plugged into the wall outlet does not exceed the fuse rating.

- Do not overload a power outlet, strip or receptacle by plugging in too many devices. The overall system load must not exceed 80% of the branch circuit rating. If power strips are used, the load should not exceed 80% of the power strip's input rating.
- This product's power cord is equipped with a three-wire grounded plug. The plug only fits in a grounded power outlet. Make sure the power outlet is properly grounded before inserting the power cord plug. Do not insert the plug into a non-grounded power outlet. Contact your electrician for details.



.....

Warning! The grounding pin is a safety feature. Using a power outlet that is not properly grounded may result in electric shock and/or injury.



.....

Note: The grounding pin also provides good protection from unexpected noise produced by other nearby electrical devices that may interfere with the performance of this product.

- Use the product only with the supplied power supply cord set. If you need to replace the power cord set, make sure that the new power cord meets the following requirements: detachable type, UL listed/CSA certified, type SPT-2, rated 7 A 125 V minimum, VDE approved or its equivalent, 4.5 meters (15 feet) maximum length.

Product servicing

Do not attempt to service this product yourself, as opening or removing covers may expose you to dangerous voltage points or other risks. Refer all servicing to qualified service personnel.

Unplug this product from the wall outlet and refer servicing to qualified service personnel when:

- the power cord or plug is damaged, cut or frayed
- liquid was spilled into the product
- the product was exposed to rain or water
- the product has been dropped or the case has been damaged
- the product exhibits a distinct change in performance, indicating a need for service
- the product does not operate normally after following the operating instructions



Note: Adjust only those controls that are covered by the operating instructions, since improper adjustment of other controls may result in damage and will often require extensive work by a qualified technician to restore the product to normal condition.

Potentially explosive environments

Switch off your device in any area with a potentially explosive atmosphere and obey all signs and instructions. Potentially explosive atmospheres include areas where you would normally be advised to turn off your vehicle engine. Sparks in such areas could cause an explosion or fire resulting in bodily injury or even death. Switch off the device near gas pumps at service stations. Observe restrictions on the use of radio equipment in fuel depots, storage and distribution areas; chemical plants; or where blasting operations are in progress. Areas with a potentially explosive atmosphere are often, but not always, marked. They include below deck on boats, chemical transfer or storage facilities, vehicles using liquefied petroleum gas (such as propane or butane), and areas where the air contains chemicals or particles such as grain, dust or metal powders.

Additional safety information

Your device and its enhancements may contain small parts. Keep them out of the reach of small children.

IT Equipment Recycling Information

Acer is strongly committed to environmental protection and views recycling, in the form of salvaging and disposal of used equipment, as one of the company's top priorities in minimizing the burden placed on the environment.

We at Acer are very conscious of the environmental effects of our business and strive to identify and provide the best working procedures to reduce the environmental impact of our products.

For more information and help when recycling, please go to this website:

<http://www.acer-group.com/public/Sustainability>

Visit www.acer-group.com for further information on the features and benefits of our other products.

Disposal instructions

Do not throw this electronic device into the trash when discarding. To minimize pollution and ensure utmost protection of the global environment, please recycle. For more information on the Waste from Electrical and Electronics Equipment (WEEE) regulations, visit <http://www.acer-group.com/public/Sustainability>



LCD pixel statement

The LCD unit is produced with high-precision manufacturing techniques. Nevertheless, some pixels may occasionally misfire or appear as black or red dots. This has no effect on the recorded image and does not constitute a malfunction.

For displays with glossy bezels the user should consider the placement of the display as the bezel may cause disturbing reflections from surrounding light and bright surfaces.

This product has been shipped enabled for power management:

- Activate display's Sleep mode within 15 minutes of user inactivity.
- Activate computer's Sleep mode within 30 minutes of user inactivity.
- Wake the computer from Sleep mode by pushing the power button.

Tips and information for comfortable use

Computer users may complain of eyestrain and headaches after prolonged use. Users are also at risk of physical injury after long hours of working in front of a computer. Long work periods, bad posture, poor work habits, stress, inadequate working conditions, personal health and other factors greatly increase the risk of physical injury.

Incorrect computer usage may lead to carpal tunnel syndrome, tendonitis, tenosynovitis or other musculoskeletal disorders. The following symptoms may appear in the hands, wrists, arms, shoulders, neck or back:

- numbness, or a burning or tingling sensation
- aching, soreness or tenderness
- pain, swelling or throbbing
- stiffness or tightness
- coldness or weakness

If you have these symptoms, or any other recurring or persistent discomfort and/or pain related to computer use, consult a physician immediately and inform your company's health and safety department.

The following section provides tips for more comfortable computer use.

Finding your comfort zone

Find your comfort zone by adjusting the viewing angle of the monitor, using a footrest, or raising your sitting height to achieve maximum comfort. Observe the following tips:

- refrain from staying too long in one fixed posture
- avoid slouching forward and/or leaning backward
- stand up and walk around regularly to remove the strain on your leg muscles

Taking care of your vision

Long viewing hours, wearing incorrect glasses or contact lenses, glare, excessive room lighting, poorly focused screens, very small typefaces and low-contrast displays could stress your eyes. The following sections provide suggestions on how to reduce eyestrain.

Eyes

- Rest your eyes frequently.
- Give your eyes regular breaks by looking away from the monitor and focusing on a distant point.
- Blink frequently to keep your eyes from drying out.

Display

- Keep your display clean.
- Keep your head at a higher level than the top edge of the display so your eyes point downward when looking at the middle of the display.
- Adjust the display brightness and/or contrast to a comfortable level for enhanced text readability and graphics clarity.
- Eliminate glare and reflections by:
 - placing your display in such a way that the side faces the window or any light source
 - minimizing room light by using drapes, shades or blinds
 - using a task light
 - changing the display's viewing angle
 - using a glare-reduction filter
 - using a display visor, such as a piece of cardboard extended from the display's top front edge
- Avoid adjusting your display to an awkward viewing angle.
- Avoid looking at bright light sources, such as open windows, for extended periods of time.

Developing good work habits

Develop the following work habits to make your computer use more relaxing and productive:

- Take short breaks regularly and often.
- Perform some stretching exercises.
- Breathe fresh air as often as possible.
- Exercise regularly and maintain a healthy body.



Acer Incorporated
8F, 88, Sec. 1, Xintai 5th Rd., Xizhi
New Taipei City 221, Taiwan

Declaration of Conformity

We,

Acer Incorporated

8F, 88, Sec. 1, Xintai 5th Rd., Xizhi, New Taipei City 221, Taiwan
Contact Person: Mr. RU Jan, e-mail:ru.jan@acer.com

And,

Acer Italy s.r.l

Via Lepetit, 40, 20020 Lainate (MI) Italy
Tel: +39-02-939-921 ,Fax: +39-02 9399-2913
www.acer.it

Declare under our own responsibility that the product:

Product: LCD Monitor
Trade Name: Acer
Model Number: XF270HU
SKU Number: XF270HU xxxxxx;
("x" = 0~9, a ~ z, A ~ Z, or blank)

To which this declaration refers conforms to the relevant standard or other standard ing documents:

- EN55022:2010 Class B; EN55024:2010
- EN 61000-3-2:2006+A1:2009+A2:2009, Class D
- EN61000-3-3:2008
- EN60950-1:2006/A11:2009/A1:2010+A12:2011
- Regulation (EC) No. 1275/ 2008; EN 50564:2011; IEC 62301:2011
- EN50581:2012

We hereby declare above product is in compliance with the essential requirements and other relevant provisions of EMC Directive 2004/108/EC, Low Voltage Directive 2006/95/EC, and RoHS Directive 2011/65/EU and Directive 2009/125/EC with regard to establishing a framework for the setting of ecodesign requirements for energy-related product.

Year to begin affixing CE marking 2015.

RU Jan / Sr. Manager
Regulation, Acer Inc.

Aug. 10, 2015
Date



Acer America Corporation
333 West San Carlos St., Suite 1500
San Jose, CA 95110, U. S. A.
Tel : 254-298-4000
Fax : 254-298-4147
www.acer.com



Federal Communications Commission Declaration of Conformity

This device complies with Part 15 of the FCC Rules. Operation is subject to the following two conditions: (1) this device may not cause harmful interference, and (2) this device must accept any interference received, including interference that may cause undesired operation.

The following local Manufacturer /Importer is responsible for this declaration:

Product:	LCD Monitor
Model Number:	XF270HU
SKU Number:	XF70HU xx xxxx ; ("x" = 0~9, a ~ z, A ~ Z or Blank)
Name of Responsible Party:	Acer America Corporation
Address of Responsible Party:	333 West San Carlos St. Suite 1500 San Jose, CA 95110 U. S. A.
Contact Person:	Acer Representative
Phone No.:	254-298-4000
Fax No.:	254-298-4147

Special notes on LCD monitors	iii
Information for your safety and comfort	iii
Safety instructions	iii
Cleaning your monitor	iii
Connecting/disconnecting the device	iii
Accessibility	iv
Safe listening	iv
Warnings	iv
Using electrical power	iv
Product servicing	v
Additional safety information	vi
IT equipment recycling information	vi
Disposal instructions	vii
LCD pixel statement	vii
Tips and information for comfortable use	viii
Federal Communications Commission	
Declaration of Conformity	xi
Unpacking	1
Attaching/removing the base	2
Screen position adjustment	2
Connecting the power cord	5
Power saving	5
Display Data Channel (DDC)	5
Connector pin assignment	6
Standard timing table	8
Installation	9
User controls	10
How to adjust a setting	11
Acer eColor Management	12
User	13
Troubleshooting	15
DP mode	15

Unpacking

Please check that the following items are present when you unpack the box, and save the packing materials in case you need to ship or transport the monitor in the future.

LCD monitor

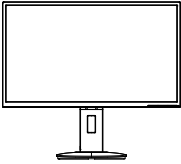

Quick start guide



DP cable (Option)

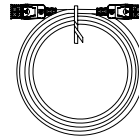

HDMI Cable
(Optional)

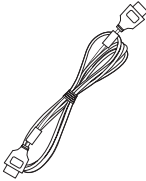

DVI cable (Optional)

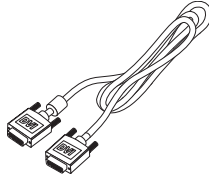

AC power cord

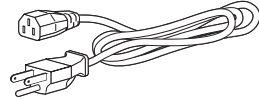

Audio Cable (Optional)

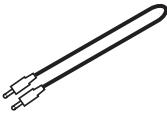

USB cable (Optional)

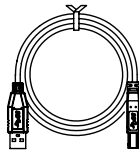

MHL cable
(Optional)

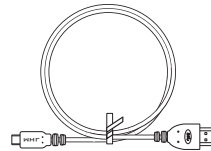

ATTACHING/REMOVING THE BASE

Install: Align the base with the stand and push the base towards the top of the monitor, and then rotate the base clockwise. Tighten the screw clockwise.

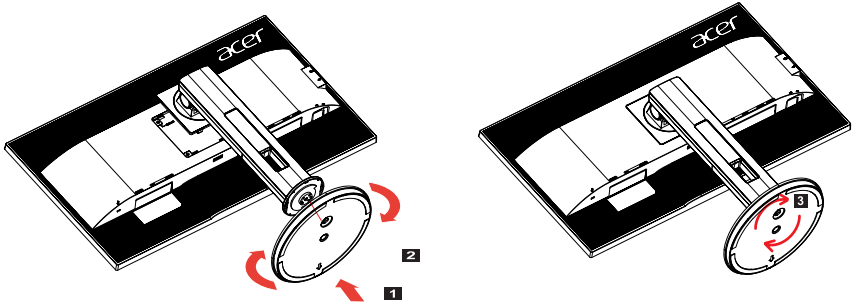

Remove: Reverse the steps to remove the base.

SCREEN POSITION ADJUSTMENT

In order to optimize the best viewing position, you can adjust the height/tilt/swivel/pivot of the monitor.

- **Height Adjustment**

After pressing the top of the monitor then you can adjust the height of the monitor.

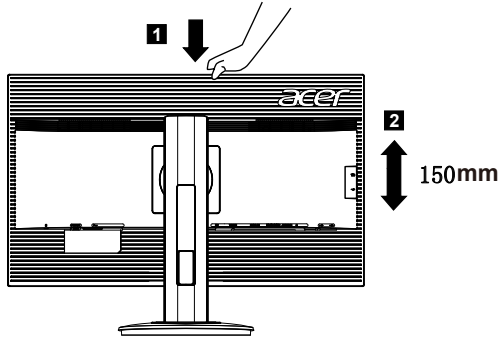

- **Tilt**

Please see the illustration below for an example of the tilt range.

Only at the highest point can 35 degrees of recline be offered for the angle of elevation.

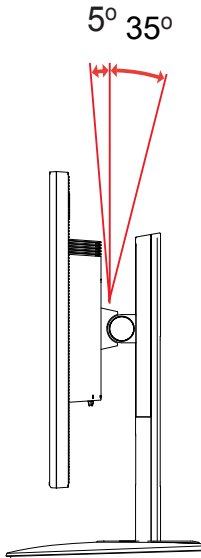

- **Swivel**

With the built-in pedestal, you can swivel the monitor for the most comfortable viewing angle.

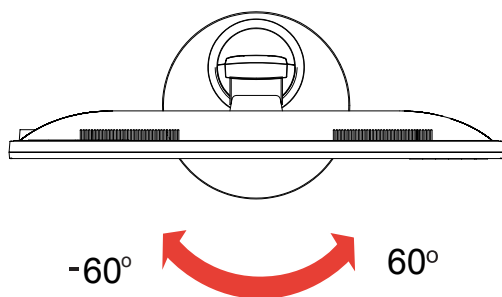

- **Monitor Pivot**

Before rotating the display, lift it to the top position and then push it back to the utmost degree.

Rotate clockwise until the monitor stops at 90° .

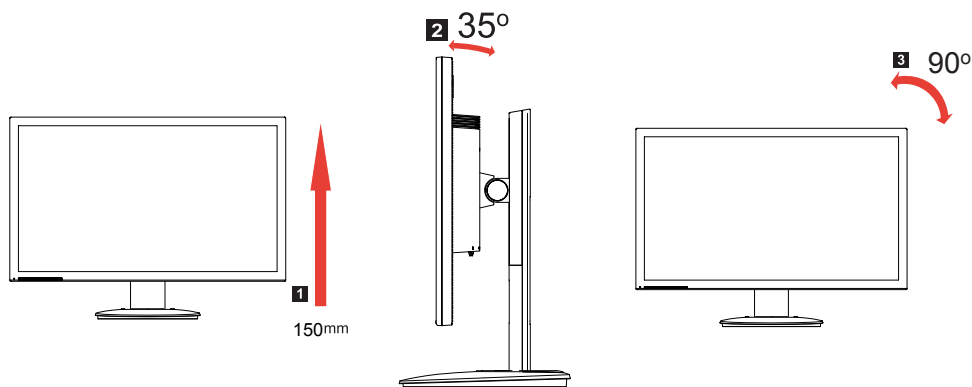

Connecting the power cord

- Check first to make sure that the power cord you use is the correct type required for your area.
- The monitor has a universal power supply that allows operation in either 100/120 V AC or 220/240 V AC voltage area. No user-adjustment is required.
- Plug one end of the power cord to the AC inlet, and plug the other end into an AC outlet.
- For units using 120 V AC:
Use a UL-listed cord set, type SVT wire and plug rated 10 A/125 V.
- For units using 220/240 V AC:
Use a cord set consisting of H05VV-F cord and plug rated 10 A/250 V. The cord set should have the appropriate safety approvals for the country in which the equipment will be installed.

Power saving

The monitor will be switched to "power saving" mode by the control signal from the display controller, as indicated by the amber-colored power LED.

Mode	LED light
On	Blue
Power saving	Amber

The power saving mode will be kept until a control signal has been detected or the keyboard or mouse is activated. The recovery time from "power saving" mode back to "on" is around 3 seconds.

Display Data Channel (DDC)

To make installation easier, so long as your system supports the DDC protocol, the monitor is able to plug-and-play. The DDC is a communication protocol through which the monitor automatically informs the host system about its capabilities; for example, supported resolutions and corresponding timing. The monitor supports the DDC2B standard.

Connector pin assignment

24-pin color display signal cable

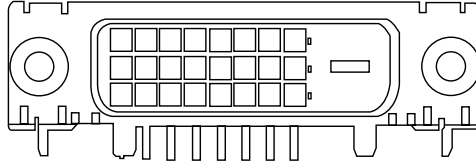

24-pin color display signal cable*

PIN No.	Description	PIN No.	Description
1	TMDS data 2-	13	NC
2	TMDS data 2+	14	+5 V power
3	TMDS data 2/4 shield	15	GND (return for +5 V hsync.vsync)
4	NC	16	Hot-plug detection
5	NC	17	TMDS data 0-
6	DDC clock	18	TMDS data 0+
7	DDC data	19	TMDS data 0/5 shield
8	NC	20	NC
9	TMDS data 1-	21	NC
10	TMDS data 1+	22	TMDS clock shield
11	TMDS data 1/3 shield	23	TMDS clock+
12	NC	24	DDC TMDS clock-

PIN NO.	DESCRIPTION
7.	MH
9.	MH
18.	V
19.	C
5, 11, 17	GND

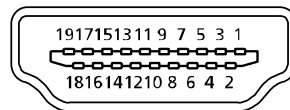

*19-Pin Color Display Signal Cable

*Only for MHL models

Standard timing table

Mode		Resolution	
1	VGA	640 x 480	60HZ
2	VGA	640 x 480	67HZ
3	VGA	640 x 480	75HZ
4	SVGA	800 x 600	56HZ
5	SVGA	800 x 600	60HZ
6	SVGA	800 x 600	72HZ
7	SVGA	800 x 600	75HZ
8	SVGA	832 x 624	75HZ
9	XGA	1024 x 768	60HZ
10	XGA	1024 x 768	70HZ
11	XGA	1024 x 768	75HZ
12	XGA	1152 x 864	75Hz
13	XGA	1280 x1024	60HZ
14	XGA	1280 x1024	75HZ
15	WXGA+	1440 x 900	60HZ
16	FHD	1920 x 1080	60HZ
17	QHD	2560 x 1440	60HZ
18	FHD	1920 x 1080	100HZ FOR HDMI
19	FHD	1920 x 1080	120HZ FOR HDMI
20	QHD	2560 x 1440	100HZ FOR HDMI2.0/DP
21	QHD	2560 x 1440	120HZ FOR HDMI2.0/DP
22	QHD	2560 x 1440	144HZ FOR HDMI2.0/DP

Installation

To install the monitor on your host system, please follow the steps below:

Steps

- 1 Connect the video cable
 - a Make sure both the monitor and computer are switched off.
 - b Connect the digital cable (only for DP models).
 - (1) Make sure both the monitor and computer are switched off.
 - (2) Connect one end of the 20-pin DP cable to the back of the monitor and the other end to the computer's port.
- 2 Connect the power cord
Connect the power cord to the monitor, then to a properly grounded AC outlet.
- 3 Connect the USB Cable(Optional)
Connect the USB 3.0 cable to port for fast charge.
Connect the USB 3.0 cable to port.
- 4 Turn on the monitor and computer
Turn on the monitor first, then the computer. This sequence is very important.
- 5 If the monitor does not function properly, please refer to the troubleshooting section to diagnose the problem.

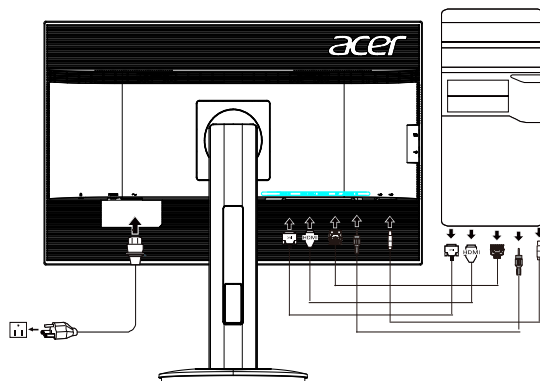

User controls



Power Switch / Power LED:

Turns the monitor ON or OFF by pressing the power switch (key no. 2 above). The LED lights up to indicate the power is turned ON.

Using the Shortcut Menu



Press any function key to open the shortcut menu. The shortcut menu lets you quickly select the most commonly accessed settings.

***e* Empowering:** Press the Empowering Key to open the Acer eColor Management OSD and access the scenario modes.

Brightness:

Press this key to open the Brightness control and set it to your preferred level.

Overdrive:

Press this key to activate the Overdrive function and set it to either Normal or Extreme mode.

ULMB:

Press this key to open the ULMB function and set it to your preferred setting.

MENU OSD functions

Press this key to activate the OSD menu.

Acer eColor Management



- Operation instructions
 - 1 Press the "e" Key to open the Acer eColor Management OSD and access the scenario modes.
 - 2 Press "◀" or "▶" to select a mode.
 - 3 Press the "Auto" Key to confirm the mode and exit the eColor menu.
- Features and benefits

Main menu icon	Sub Menu icon	Sub menu item	Description
	N/A	User mode	User defined. Settings can be fine-tuned to suit any situation.
	N/A	ECO mode	Adjusts the settings to reduce power consumption.
	N/A	Standard mode	Default Setting. Reflects native display capability
	N/A	Graphic mode	Enhances colors and emphasizes fine detail. Pictures and photographs appear in vibrant colors with sharp detail.
	N/A	Movie mode	Displays scenes in clearest detail. Presents great visuals, even in unsuitably lit environments.

Adjusting the OSD settings



Note: The following content is for general reference only. Actual product specifications may vary.

The on-screen display (OSD) can be used for adjusting the settings of your LCD Monitor. Press any MENU key to open the OSD. You can use the OSD to adjust picture quality, OSD position and general settings. For advanced settings, please refer to following pages:

Adjusting Brightness

Open the Brightness control and adjust the brightness level using the adjustment arrows. When you are done, use Exit to go back one level.



Adjusting the Overdrive setting

Open the Overdrive control and select the overdrive setting using the adjustment arrows. When you are done, use Exit to go back one level.

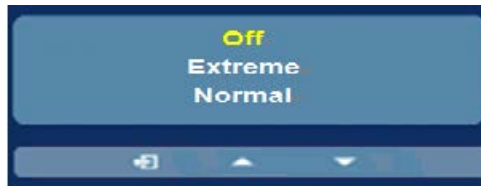

Adjusting picture quality



- 1 Press any **MENU** key to bring up the OSD.
- 2 Using the ◀/▶ keys, select  Picture from the OSD then navigate to the setting you want to adjust.
- 3 Use the ◀/▶ keys to adjust the setting.
- 4 You can use the Picture menu to adjust Color settings, Brightness, Contrast, the Gamma setting and Color Temperature.

Adjusting OSD settings



- 1 Press any MENU key to bring up the OSD.
- 2 Using the directional keys, select  OSD then navigate to the setting you want to adjust.

Adjusting miscellaneous settings



- 1 Press any MENU key to bring up the OSD.
- 2 Using the ◀/▶ keys, select  Setting from the OSD, then navigate to the setting you want to adjust.
- 3 The Setting menu can be used to adjust the screen Menu Language and other important settings including Input, Overdrive level, ULMB and Refresh Rate.
- 4 Select Power-off USB charge ON/OFF to enable or disable the Power-off USB charging function.

Product information



- 1 Press any MENU key to bring up the OSD.
- 2 Using the ◀/▶ keys, select  Information from the OSD to display some of the monitor's general information and settings.

G-SYNC Experience:

G-SYNC requires an NVIDIA GeForce GTX650Ti BOOST GPU or higher. For more information, visit the nVidia® website: <http://www.nvidia.com/page/home.html>

Troubleshooting

Before sending your LCD monitor for servicing, please check the troubleshooting list below to see if you can self-diagnose the problem.

DP mode

Problem	LED status	Remedy
No picture visible	Blue	Using the OSD, adjust brightness and contrast to maximum or reset to their default settings.
	Off	Check the power switch. Check if the AC power cord is properly connected to the monitor.
	Amber	Check if the video signal cable is properly connected at the back of monitor. Check that the computer system is switched on and in power saving/standby mode.