



HOOVER



USER MANUAL



PRINTED IN P.R.C.
48021208/01

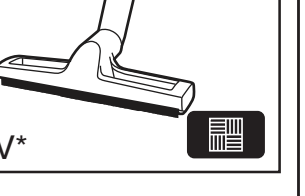
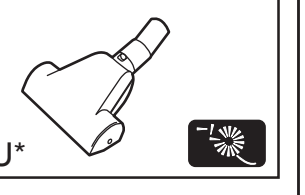
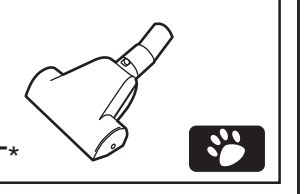
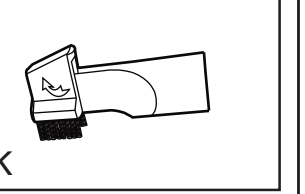
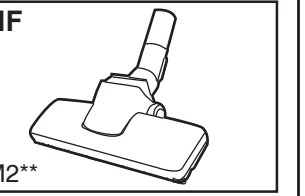
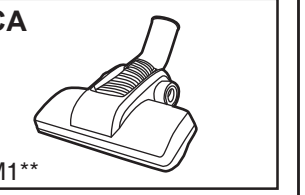
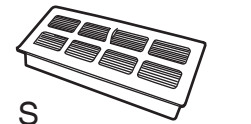
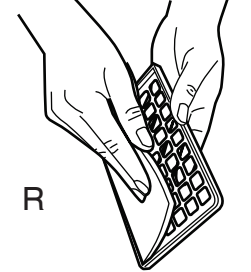
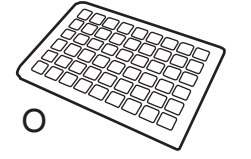
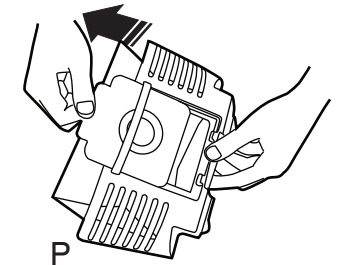
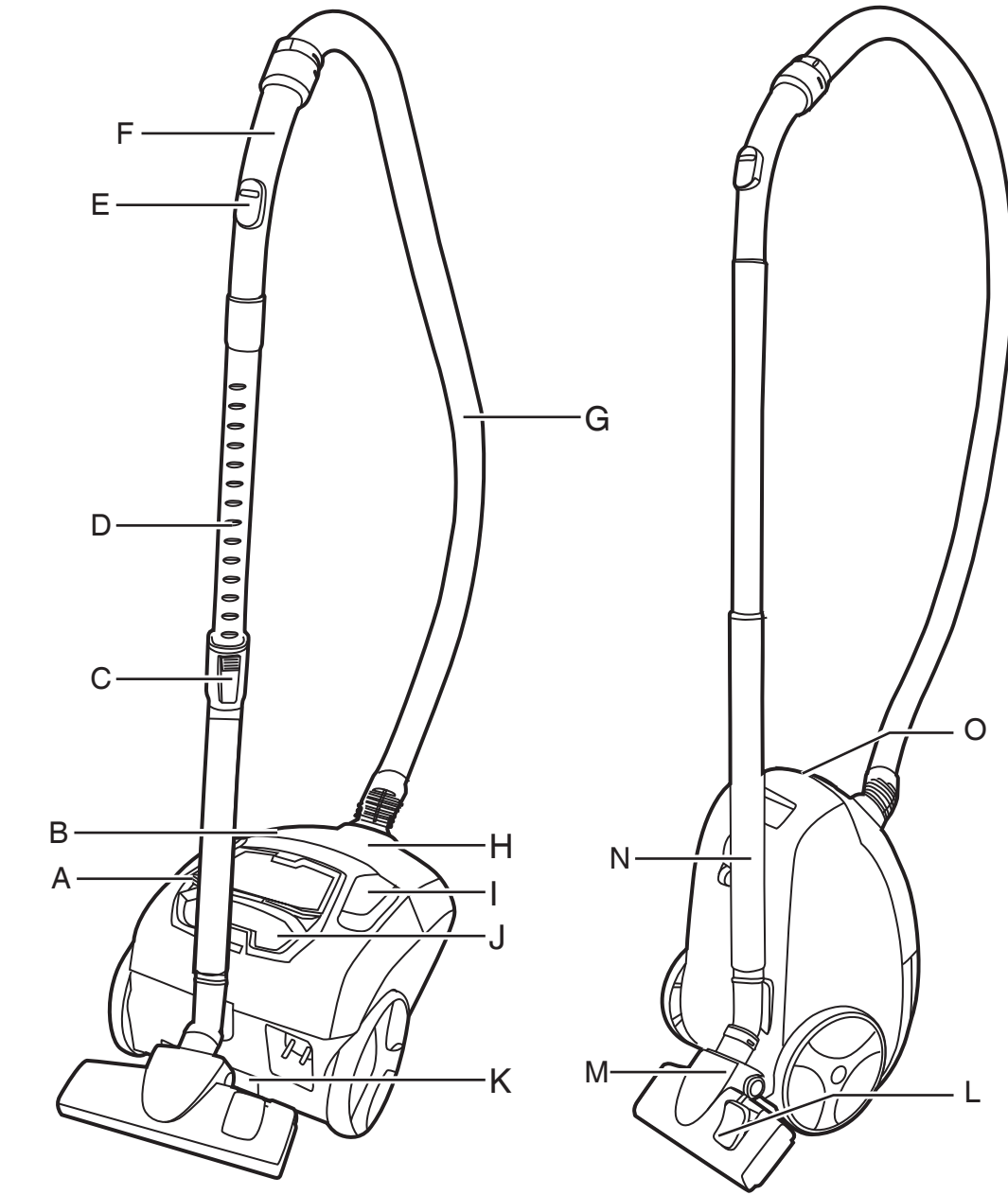

* Certain models only

** Certain models only, nozzles may vary according to model

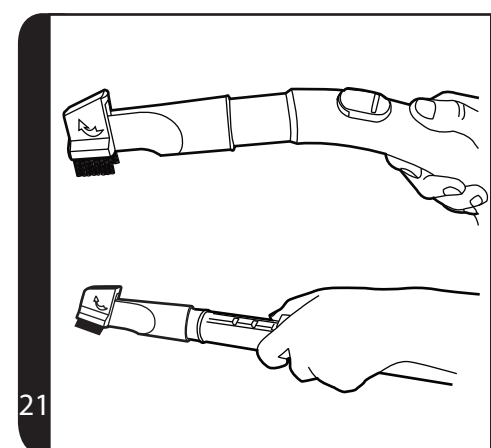
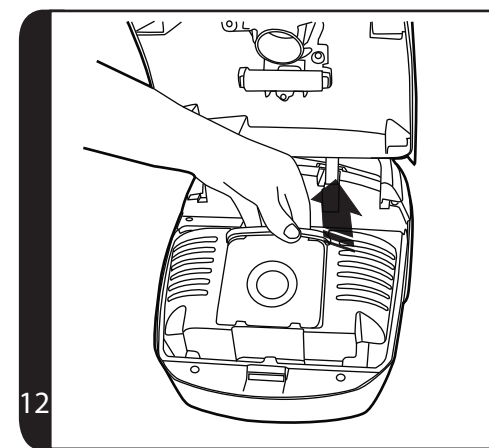
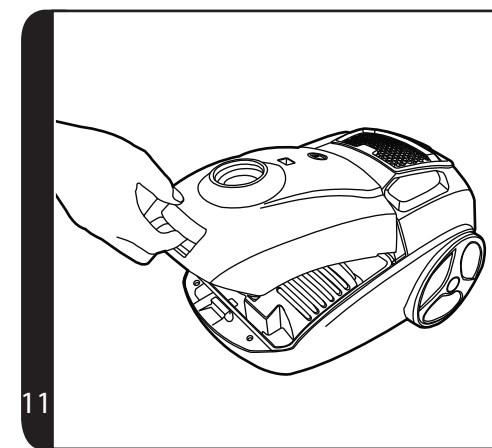
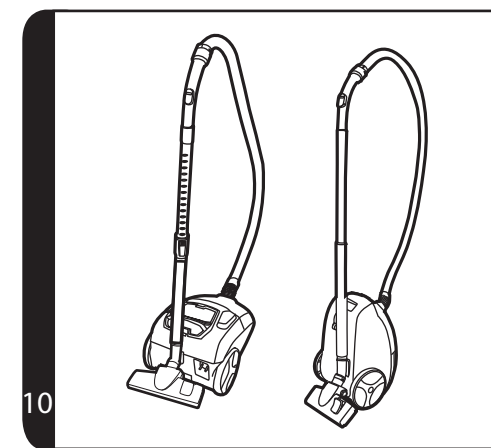
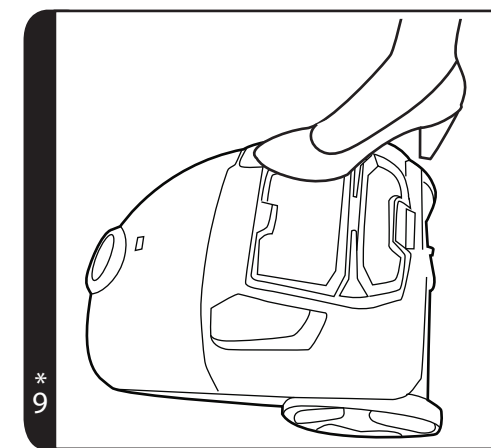
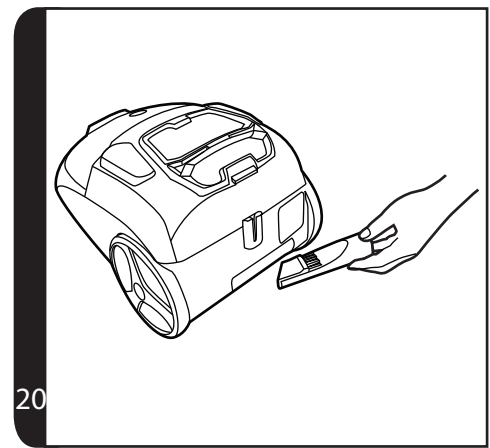
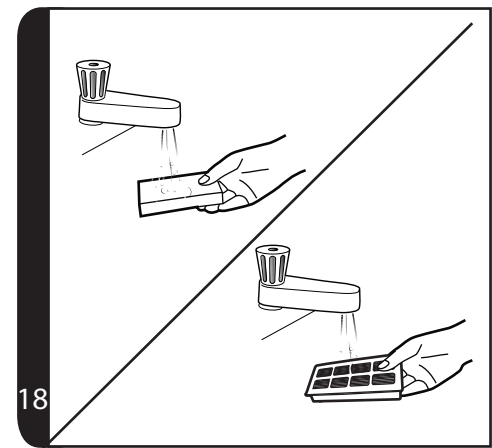
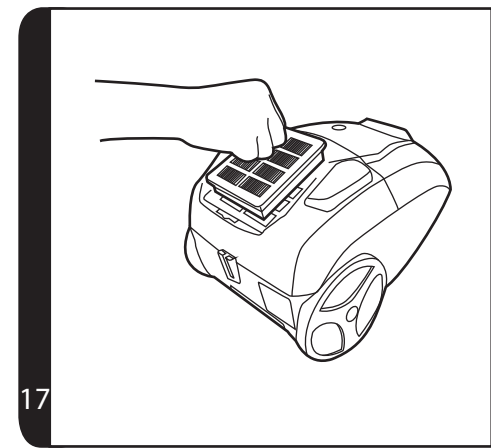
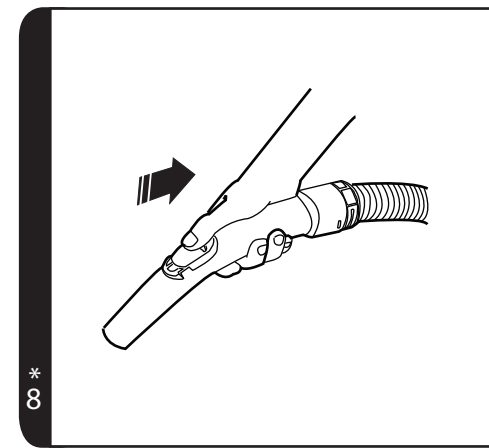
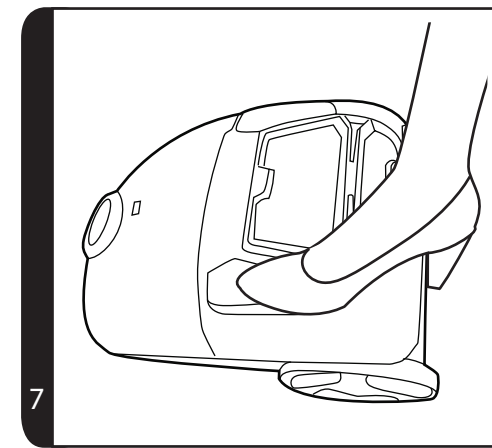
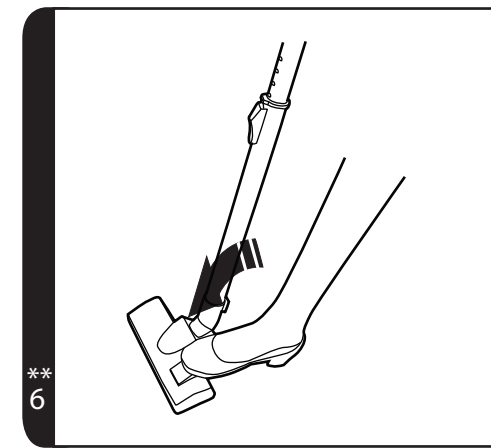
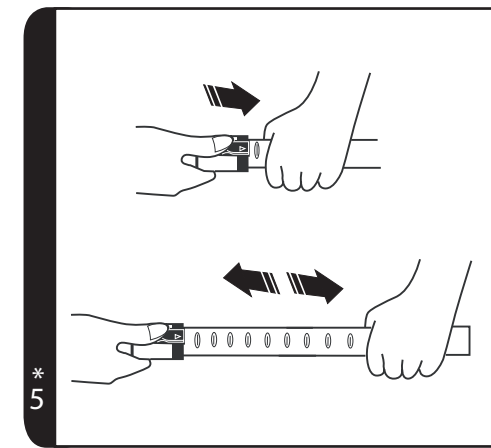
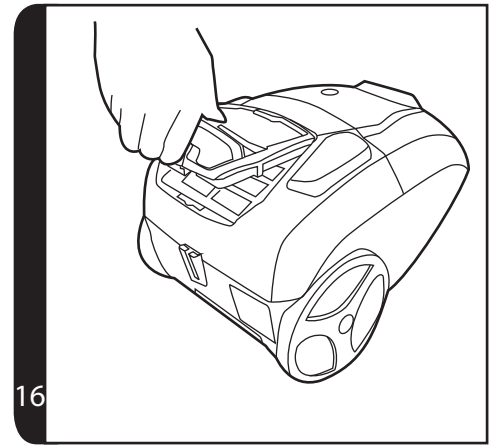
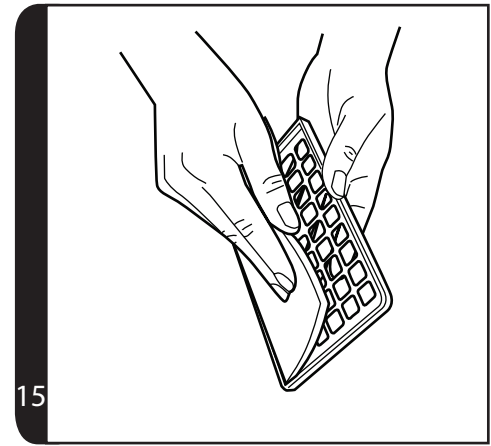
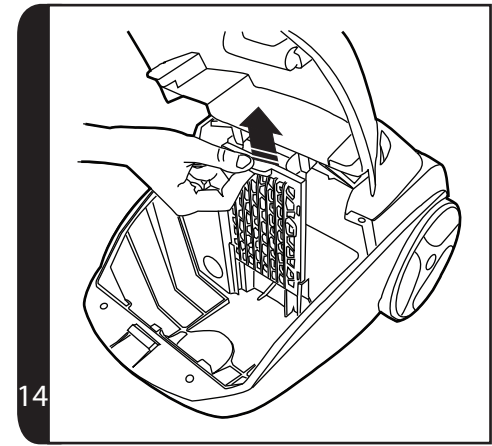
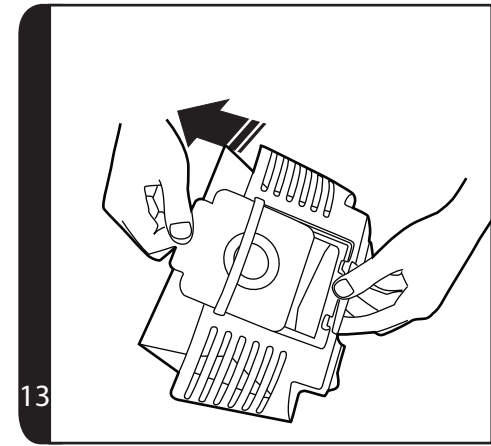
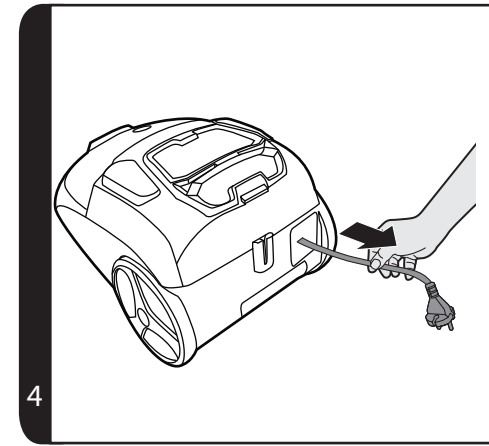
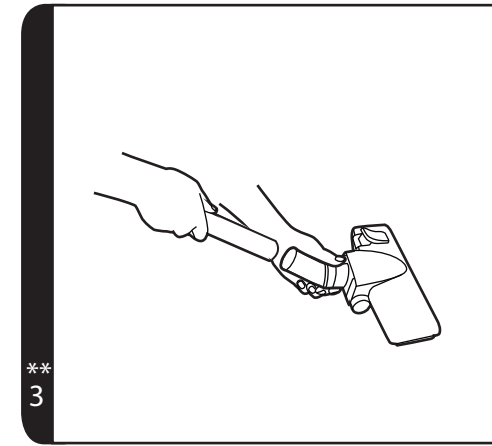
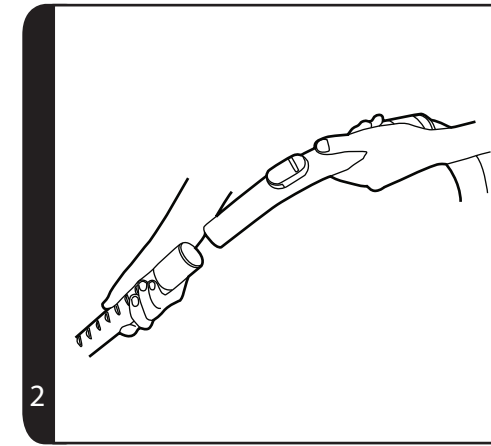
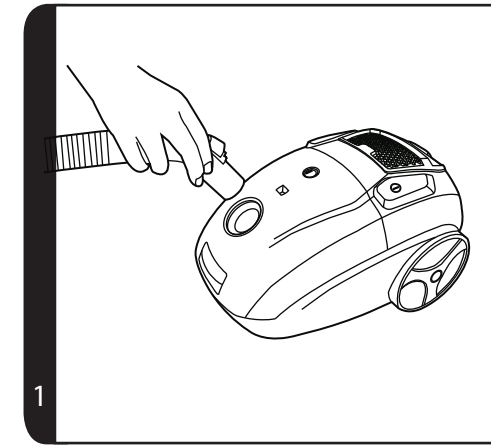

* Certain models only

** Certain models only, nozzles may vary according to model

INSTRUCTIONS FOR SAFE USE

This appliance should only be used for domestic cleaning, as described in this user guide. Please ensure that this guide is fully understood before operating the appliance.

Do not leave the appliance plugged in. Always switch off and remove the plug from the socket after use, or before cleaning the appliance or any maintenance task.

This appliance can be used by children aged from 8 years and above and persons with reduced physical, sensory or mental capabilities or lack of experience and knowledge if they have been given supervision or instruction concerning use of the appliance in a safe way and understand the hazards involved. Children shall not play with the appliance. Cleaning and user maintenance shall not be made by children without supervision.

If the power cord is damaged stop using the appliance immediately. To avoid a safety hazard, an authorised HOOVER service engineer must replace the power cord.

Keep hands, feet, loose clothing and hair away from rotating brushes.

Use only attachments, consumables or spares recommended or supplied by HOOVER.

Static electricity: Some carpets can cause a small build up of static electricity. Any static discharge is not hazardous to health.

Do not use your appliance out of doors or on any wet surface or for wet pick up.

Do not pick up hard or sharp objects, matches, hot ashes, cigarette ends or other similar items.

Do not spray with or pick up flammable liquids, cleaning fluids, aerosols or their vapours.

Do not run over the power cord when using your appliance or remove the plug by pulling on the power cord.

Do not continue to use your appliance if it appears faulty.

HOOVER service: To ensure the continued safe and efficient operation of this appliance we recommend that any servicing or repairs are only carried out by an authorised HOOVER service engineer.

Do not stand on or wrap the cord around arms or legs when using your appliance.

Do not use the appliance to clean animals or people.

Do not position the appliance above you when cleaning the stairs.

The Environment

The symbol on this appliance indicates that this appliance may not be treated as household waste. Instead it must be handed over to the applicable collection point for the recycling of electrical and electronic equipment. Disposal must be carried out in accordance with local environmental regulations for waste disposal. For more detailed information about treatment, recovery and recycling of this appliance, please contact your local city office, your household and waste disposal service or the shop where you purchased the appliance.



 This product complies with the European Directives 2014/35/EU, 2014/30/EU and 2011/65/EU.

CANDY HOOVER GROUP S.r.l. Via Privata Eden Fumagalli, 20861 Brugherio (MB) Italy

GETTING TO KNOW YOUR CLEANER

- | | |
|-----------------------------|--|
| A. On/Off Button | M. Carpet and Floor Nozzle (GP) ** |
| B. Bag Door | M1. Carpet Nozzle (CA) ** |
| C. Telescopic Tube Adjuster | M2. Hard Floor Nozzle (HF) ** |
| D. Telescopic Tube | N. Main Cleaner |
| E. Suction Regulator | O. Bag Door Release Latch |
| F. Hose Handle | P. Bag Holder |
| G. Hose | Q. Pre-motor Filter Frame |
| H. Bag Check Indicator | R. Pre-motor Filter |
| I. Cord Rewind Button | S. Exhaust Filter |
| J. Exhaust Filter Cover | T. Pet Hair Remover Mini Turbo Nozzle* |
| K. 2 in 1 Tool | U. Allergy Remover Mini Turbo Nozzle* |
| L. Floor Type Selector* | V. Parquet Nozzle* |

ASSEMBLING YOUR CLEANER

Remove all components from the packaging.

1. Connect the hose to the cleaner main body, ensuring it clips and locks into position. [1]
To release: simply press the two buttons on the hose end and pull. [1]
2. Connect the tube upper end to the handle. [2].
3. Connect the tube lower end to the carpet and floor nozzle**. [3]

USING YOUR CLEANER

1. Extract power cord and plug it into the power supply. Do not pull the cord beyond the red marker. [4]
2. Adjust the length of telescopic tube by moving the telescopic tube adjuster up, and raise or lower the handle to the most comfortable cleaning position. [5]
3. Carpet and Floor Nozzle**: Press the floor type selector pedal* on the nozzle to select the ideal cleaning mode for the floor type. [6]
Hard Floor: The brushes are lowered to protect the floor
Carpet: With lifted brushes for the deepest clean
4. Switch the cleaner on by pressing the on/off button on the cleaner main body. [7]
5. Adjust the suction regulator to the desired level. [8]
6. Switch off at the end of use by pressing the on/off button. Unplug and press the cord rewind button to wind the power cord back into the cleaner. [9]
7. Packing and storage – The tube can be parked for temporary storage while in use, or in the storage position when not in use. [10]

*Certain Models Only ** Certain models only, nozzles may vary according to model

CLEANER MAINTENANCE

Replacing the Dust Bag

If the bag check indicator is red please check and, if necessary, replace the bag.

1. Lift the bag door release latch [11] to open the bag door. Pull the bag holder [12] and pull the bag collar to remove the bag. [13]
2. Apply the peel and seal sticker, located on the bag collar, to the bag inlet. The full dust bag should be disposed of correctly and carefully.
3. Fold a new bag as shown on the bag and fit by inserting the collar into the bag holder. [13]
4. Refit the bag holder and close the bag door.

WARNING: The bag door will NOT close if the dust bag and/or the bag holder are not assembled to the cleaner. Always ensure the bag and bag holder are present when closing the bag door.

Remember: The bag check indicator may also be red if an obstruction has occurred. In this case, refer to 'Removing a blockage from the system'.

Cleaning the Filters

To maintain optimum performance of your cleaner, please wash the filters after each 5 bag changes.

Cleaning the pre-motor filter:

1. Lift the bag door release latch [11] to open the bag door and remove the bag. [12]
2. To remove the pre-motor filter, slide the pre-motor filter frame from the cleaner. [14]
3. Remove the filter from the holder. [15]
4. Wash it in hand warm water [18], and allow it to dry thoroughly before replacing it in the cleaner. [19]

Cleaning the exhaust filter:

1. To remove the exhaust filter, unclip the exhaust filter cover [16] and remove the exhaust filter pack. [17]
2. Wash the filter in hand warm water [18] and allow it to dry thoroughly before replacing it in the cleaner. [19]

Remember: Do not use hot water or detergents. In the unlikely event of the filters becoming damaged, fit a genuine Hoover replacement. Do not try and use the product without a dust bag or filter fitted.

Cleaning the permanent cloth dust bag*:

To maintain optimum performance we recommend that you wash the permanent cloth dust bag under hand warm water after every 5 full bags. Remove excess water and leave to dry fully before replacing.

Removing a Blockage From The System

If the bag check indicator is red:

1. Check if the bag is full. If so refer to 'Replacing the dust bag'.

2. If it is not full, then;
 - A. Do the filters need cleaning? If so refer to 'Cleaning the filter'.
 - B. Check if there is any other blockage in the system - Use a rod or a pole to remove any blockage from telescopic tube or flexible hose.

Warning - The bag check indicator will turn red if the cleaner is used when the bag is full, if there is a blockage or if the filters are dirty. If the cleaner is used for a significant period of time with bag check indicator is red, a thermal cut out will switch the cleaner off to prevent any risk of overheating. The bag check indicator turn green once the cleaner has switched off to signal that the thermal cut out has been activated. If this should happen, switch the cleaner off, unplug and correct the fault. It will take about 30 minutes for the cut out to automatically reset.

ACCESSORIES AND NOZZLES

To obtain the best performance and efficiency it is recommended that the correct nozzles are used for the main cleaning operations. These nozzles are indicated in the diagrams by the letters **GP**, **HF** or **CA**.

A nozzle type **GP** can be used to clean both carpet and hard floor.

A nozzle type **HF** is suitable for use only on hard floor.

A nozzle of type **CA** is suitable for use only on carpet.

The other nozzles are accessories for specialist cleaning tasks and are recommended for occasional use only.

All accessories can be fitted to the end of the handle or the end of the tube.

2 in 1 tool – Combines two functions in one, the 2 in 1 tool can be connected as a crevice tool. By rotating the end piece converts to a dusting brush. The 2 in 1 tool can be stored neatly at the rear of the cleaner.

Crevice Tool – For corners and hard to reach areas.

Dusting Brush – For bookshelves, frames, keyboards and other delicate areas. To extend the brushes push the button on the body of the tool.

Pet Hair Remover Mini Turbo Nozzle* – Use the mini turbo nozzle on stairs or for deep cleaning on textile surfaces and other hard to clean areas.

Allergen Remover Mini Turbo Nozzle* – Use the mini turbo nozzle on stairs or for deep cleaning on textile surfaces and other hard to clean areas.

Parquet Nozzle* – For wooden floors and other delicate floors.

IMPORTANT: Do not use the grand turbo nozzle or mini turbo nozzles on rugs with long fringes, animal hides and carpet pile deeper than 15mm. Do not keep the nozzle stationary while the brush is rotating.

*Certain Models Only ** Certain models only, nozzles may vary according to model

USER CHECKLIST

Should you have a problem with the product, complete this simple user checklist before calling your local Hoover service.

- Is there a working electricity supply to the cleaner? Please check with another electrical appliance
- Is the dust bag over-filled? Please refer to 'Cleaner Maintenance'
- Is the Filter blocked? Please refer to 'Cleaning the filter'
- Is the hose or nozzle blocked? Please refer to 'Removing a blockage from the system'
- Has the cleaner overheated? If so, it will take approximately 30 minutes to automatically reset

IMPORTANT INFORMATION

Hoover spares and Consumables

Always replace parts with genuine Hoover spares. These are available from your local Hoover dealer or direct from Hoover. When ordering parts always quote your model number.

Hoover Service

Should you require service at any time, please contact your local Hoover Service Office.

Quality

BSI ISO 9001

Hoover's factories have been independently assessed for quality. Our products are made using a quality system which meets the requirements of ISO 9001.

Your Guarantee

The guarantee conditions for this appliance are as defined by our representative in the country in which it is sold. Details regarding these conditions can be obtained from the dealer from whom the appliance was purchased. The bill of sale or receipt must be produced when making any claim under the terms of this guarantee.

Subject to change without notice.