

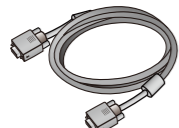

BL80 Series LCD Monitor Quick Start Guide

DN: BL80-Q-V1

© 2018 BenQ Corporation. All rights reserved. Rights of modification reserved.

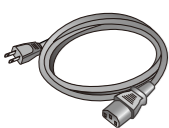
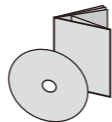
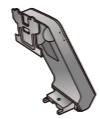
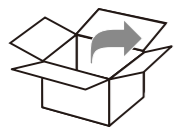
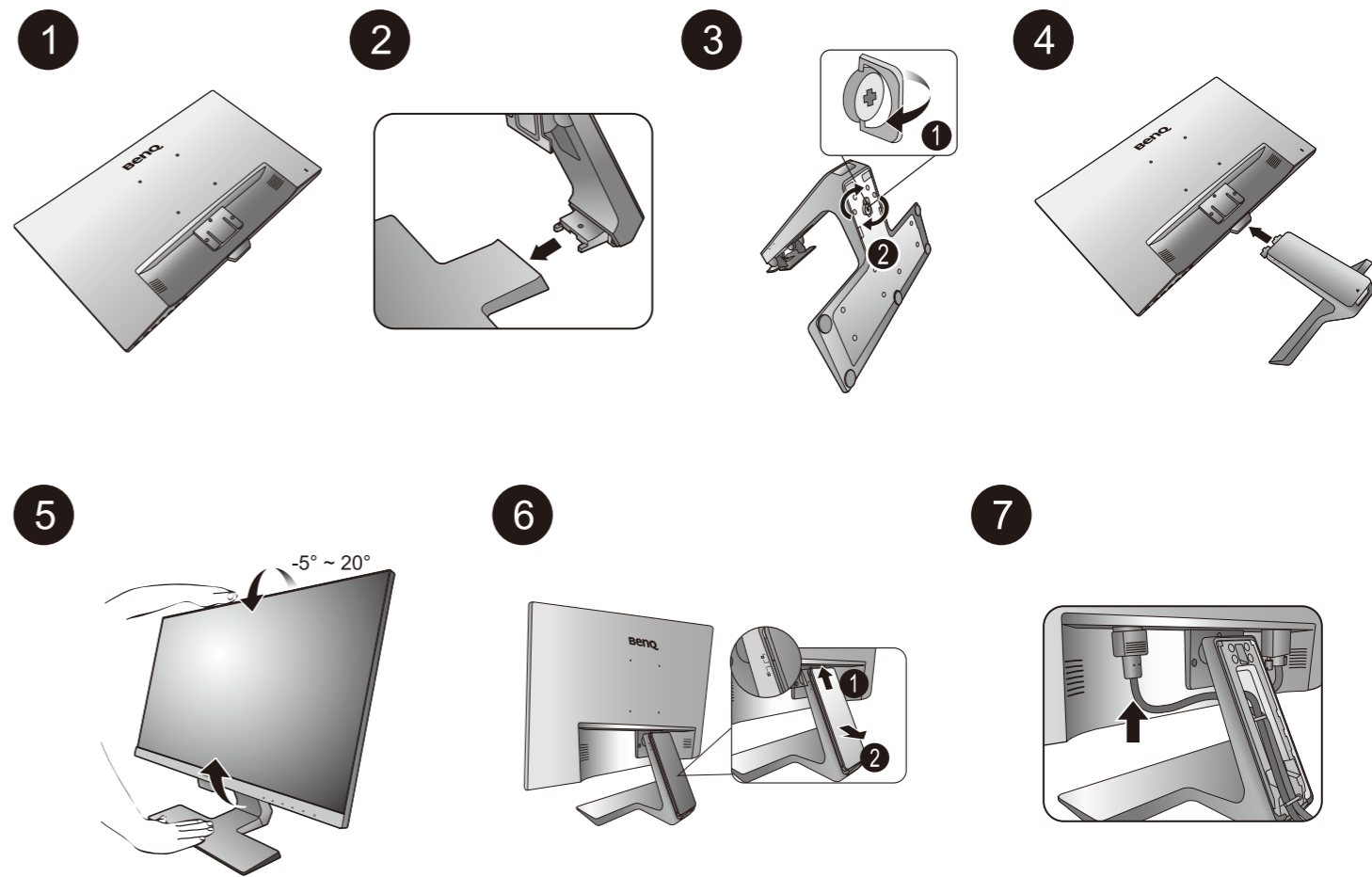

D-Sub
(Optional)

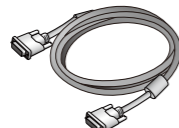

DVI
(Optional)

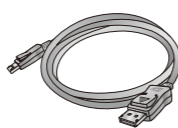

DP
(Optional)

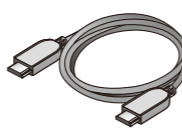

HDMI
(Optional)



Audio
(Optional)

8 Video

9 Audio

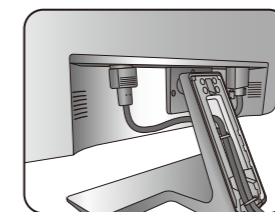

BL2480 / BL2780

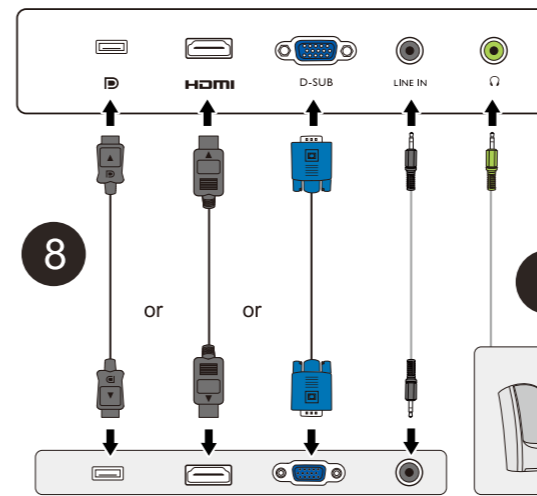

BL2283

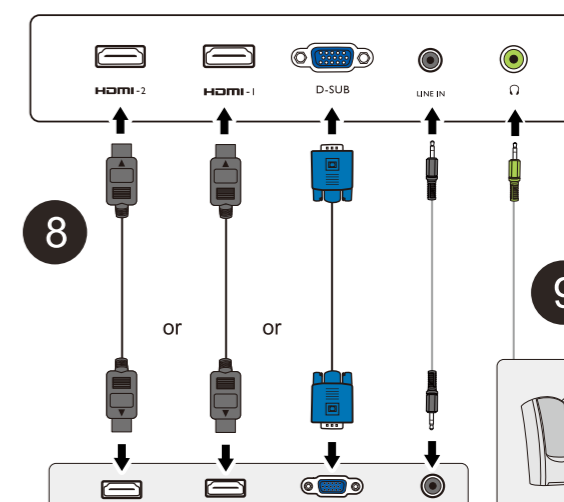

10

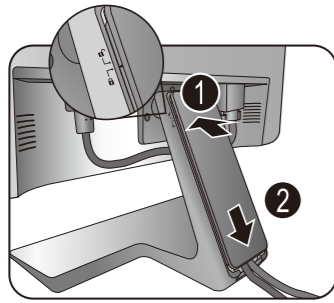

11

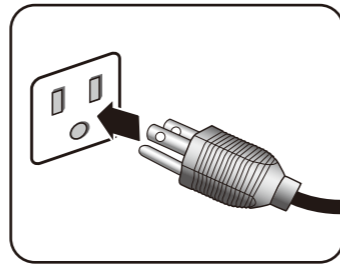

12

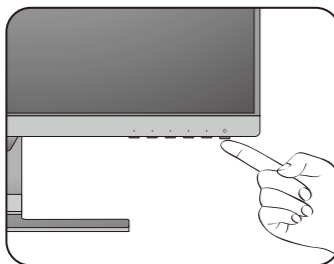

13

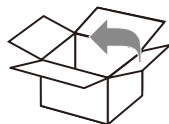
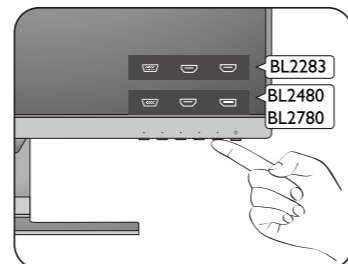

1

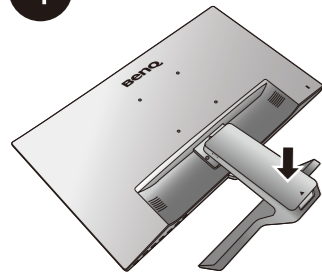

2

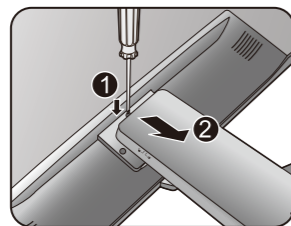

3

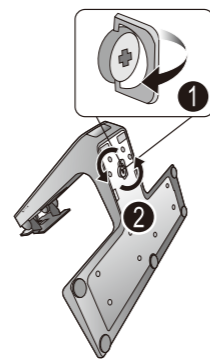

4

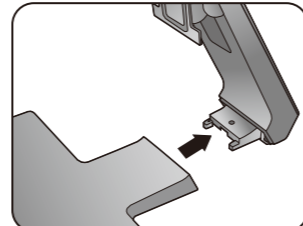

www.BenQ.com

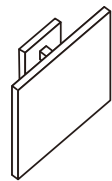

1

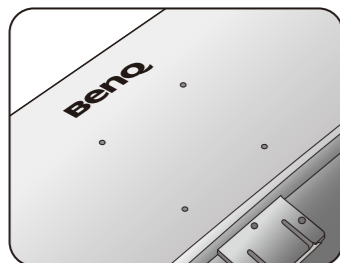

M4 x 10 mm

2

