

# SHARP

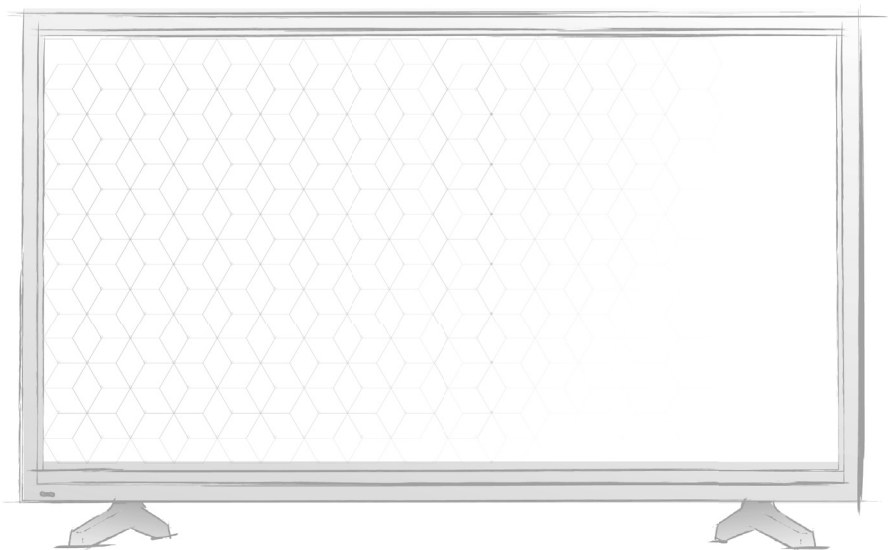

## Operating Instructions

UHD SMART Television

Image for illustration purposes only. Actual product may vary.



# IMPORTANT GUARANTEE INFORMATION

Thank you for purchasing this television. We hope you have many years of trouble free enjoyment from your purchase.

Your product is covered under the manufacturers' guarantee for 12 months from the date of purchase.

If you experience any difficulties with your TV, please refer to the 'Frequently asked questions' section at the rear of these Operating Instructions.

If you are still unable to remedy the issue, try resetting the TV to factory settings - details can be found in the 'Settings' menu section of these Operating Instructions - alternatively, please contact the helpline.

In the event that a fault is diagnosed, the helpline will arrange to collect the TV from your home or work address, return it to our service centre, repair the item and then return it to you.

If we believe we cannot offer a permanent repair, we will replace the item.

**Technical Support Information**

**Telephone UK 0330 024 0803, ROI 01443 3323**

Web support: [www.umc-uk.co.uk](http://www.umc-uk.co.uk)

Email: [service@umc-uk.co.uk](mailto:service@umc-uk.co.uk)

Calls to 0330 numbers are charged at standard call rates and are included as part of any bundled minutes with your phone provider.

The telephone opening hours are Monday to Friday 8.30am to 6pm, Saturday 9am – 5pm.

UK: Calls are charged at your normal telephone call rate.

ROI: Calls are charged at a local rate.

**Please retain all packaging materials, in addition to your proof of purchase/receipt, as you will need these in the event of warranty/service support.**

This guarantee is in addition to and does not affect your statutory rights.

If you need to call the helpline, you will need the following information.

- 1) Model No \_\_\_\_\_ (You can find this on the rear of the TV)
- 2) Date of purchase \_\_\_\_\_ (You can find this on your sales receipt)
- 3) Serial Number \_\_\_\_\_ (You can find this on the rear of the TV)

EXAMPLE OF LABEL ON REAR OF TV



This TV set is for domestic use only

## Important Safety Instructions

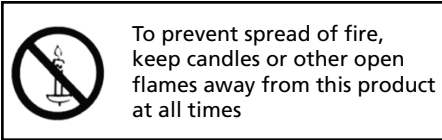

**Please read these instructions. All of the safety and operating instructions should be read before the appliance is operated.**

### Warnings

- Television sets with 40" screens or larger must be lifted and carried by at least 2 people.
- This television does not contain any parts that are serviceable by the user. In the event of a fault, contact the manufacturer or authorised service department.
- Exposing the internal parts of the TV may endanger your life. The manufacturer's guarantee does not extend to faults caused by repairs carried out by unauthorised third parties.
- Do not use the TV set immediately after unpacking. Wait until the TV warms up to room temperature before using it.
- To reduce the risk of fire, electric shock or damage to the TV, do not expose it to dust, rain or moisture. Never expose the TV to dripping or splashing and do not place objects filled with liquids on or near the TV.
- Do not connect any external devices (DVD player, games console etc.) when the TV is switched on. Disconnect both the TV and device from the mains before connecting. Only switch appliances on when the connection process is complete.
- Do not place the television in a confined space and do not obstruct the ventilation openings at the rear of the television.
- When installing on a wall, ensure the TV is at least 5cm from the wall for ventilation.
- Always ensure that the TV's ventilation openings are not covered with items such as newspapers, tablecloths, curtains, etc.
- Dispose of this television and any components including batteries in an environmentally friendly manner. If in doubt, please contact your local authority for details of recycling.
- Ensure this TV is used in moderate climates only.
- In cases of electrostatic discharge (ESD) the TV may operate incorrectly. If this happens, turn the set off at the mains and then turn back on again after 30 seconds. The set should now work normally.

**WARNING: Never place a television set on an unstable surface. The TV set may fall causing serious personal injury or death. Many injuries, particularly to children, can be avoided by taking simple precautions such as:**

- Use cabinets or stands recommended by the manufacturer of the television set.
- Only use furniture that can safely support the television set.
- Ensure the television set is not overhanging the edge of the supporting furniture.
- Do not place the television set on tall furniture (for example, cupboards or bookcases) without anchoring both the furniture and the television set to a suitable support.
- Do not place the television set on cloth or other materials that may be located between the television set and supporting furniture.
- Please educate children about the dangers of climbing on furniture to reach the television set or its controls.
- If your existing television set is being retained and relocated, the same considerations as above should be applied.

### Safety

- For your safety, this appliance is fitted with a fused 3 pin mains plug. Should the fuse need to be replaced, ensure that any replacement is of the same amperage and approved with the BSI mark.
- Never try and replace the mains plug unless you have adequate qualifications and are legally authorised to do so. In the event that a replacement mains cable is required, contact the manufacturer for a suitable replacement.
- Never use the television if it is damaged in any way.
- Always place the television on a flat level surface avoiding anywhere which may be subject to strong vibration.
- The ideal distance to watch the television is from approximately 2.5-3 times the length of the diagonal measurements of the TV screen away.
- Ensure the television is not placed on top of the power cable as the weight of the television may damage the cable and cause a safety hazard.
- Never place mobile phones, speakers or any other device which may cause magnetic or radio interference, near the television. If interference is apparent, move the device causing the interference away from the television.
- To disconnect the set from the mains, remove the mains plug from the socket.
- Ensure that the mains plug is always easily accessible.
- When handling the set do not grip the LCD screen/glass.
- Do not pull the set when mounted on a bracket. If using a moveable bracket, adjust via the bracket and not the TV set.
- Do not place this set above a heat source.

**WARNING: Excessive volume when using earphones and headphones can cause damage to hearing.**

## Important Safety Instructions



### Maintenance

- To clean your TV, wipe with a soft, dry cloth. If the surfaces are extremely dirty, use a soft cloth dampened with a weak detergent solution.
- Never use alcohol, paint thinner or benzene to clean this unit.
- Before using a chemically treated cloth, read the instructions that came with the cloth carefully.

**CAUTION: If water or other liquid enters the television through the display panel surface, a malfunction may occur.**



### Packaging

- The safest way to transport your item is in the original box/packaging - please save your packaging for this.
- You will need the original box/packaging in the event of warranty/service repair or support. We are unable to carry out warranty/service if you are unable to package the item correctly.

### Important information regarding use of video games, computers, captions or other fixed image displays

The extended use of fixed image program material can cause a permanent "shadow image" on the LCD/LED panel, also known as "screen burn".

This "shadow image" can appear in the background during normal viewing. This type of irreversible LCD/LED panel deterioration can be limited by observing the following steps:

1. Reduce the brightness/contrast setting to a minimum suitable viewing level.
2. Do not display the fixed image for extended periods of time.
3. Turn the power off when not in use.

Examples of images that are more likely to cause "screen burn" are as follows (this is not an exhaustive list):

- TV channel logos: e.g. shopping channel logos and pricing displays - especially if they are bright and stationary. Moving or low-contrast graphics are less likely to cause ageing of the screen.

- Time displays.
- Teletext: Do not view a static page for a long period of time
- TV/DVD menus: e.g. listings of DVD disc content.
- Pause mode: Do not leave the TV in pause mode for long periods of time, e.g. when watching DVDs or videos.

**Important: Once 'shadow image/screen burn' occurs, it will never disappear and is not repairable under warranty.**

### How do I dispose of this product?

UK: Waste electrical products should not be disposed of with household waste. Please dispose of the product at a designated collection point for recycling of WEEE. For your nearest facilities, please see [www.recycle-more.co.uk](http://www.recycle-more.co.uk) or ask store for details.



ROI: Waste electrical products should not be disposed of with household waste. Separate disposal facilities exist. Check with your local authority or retailer for recycling advice.



### Batteries

- Do not expose batteries to high temperatures, excessive heat, prolonged sunshine or fire as this may cause leakage, explosion or ignition. Observe the correct polarity when inserting batteries.
- Do not use different types of batteries together or mix old and new batteries.
- Dispose of batteries in an environmentally friendly way.
- Certain regions may regulate the disposal of batteries. Please consult your local authority.

#### CE Statement:

Hereby, UMC Poland Sp. z o.o. declares that this LED TV is in compliance with the essential requirements and other relevant provisions of RED Directive 2014/53/EU.

<https://www.sharpcorconsumer.eu/documents-of-conformity/>

## Trademarks

### HDMI

The terms HDMI and HDMI High-Definition Multimedia Interface, and the HDMI Logo are trademarks or registered trademarks of HDMI Licensing, LLC in the United States and other countries.



The Ultra HD Display logo is registered trademark of DIGITAL-EUROPE



The DVB logo is the registered trademark of the Digital Video Broadcasting (DVB) project.



The FREEVIEW text and logos are trademarks of DTV Services LTD. © DTV Services Ltd



SAORVIEW is a registered trademark owned by RTÉ.



Manufactured under license from Dolby Laboratories. Dolby, Dolby Audio and the double-D symbol are trademarks of Dolby Laboratories.



The "CI plus" Logo is a trademark of CI Plus LLP.



YouTube and the YouTube logo are trademarks of Google Inc.



The Wi-Fi CERTIFIED Logo and Miracast® are registered trademarks of Wi-Fi Alliance. Wi-Fi CERTIFIED Miracast™ is a trademark of Wi-Fi Alliance.



For DTS patents, see <http://patents.dts.com>. Manufactured under license from DTS Licensing Limited. DTS, the Symbol, DTS and the Symbol together, and DTS Studio Sound are registered trademarks and/or trademarks of DTS, Inc. in the United States and/or other countries. © DTS, Inc. All Rights Reserved.



For DTS patents, see <http://patents.dts.com>. Manufactured under license from DTS Licensing Limited. DTS, the Symbol, DTS and the Symbol together, DTS-HD, and the DTS-HD logo are registered trademarks and/or trademarks of DTS, Inc. in the United States and/or other countries. © DTS, Inc. All Rights Reserved.

**Note:** Trademarks may vary depending on model.

### Microsoft PlayReady™

This product contains technology subject to certain intellectual property rights of Microsoft. Use or distribution of this technology outside of this product is prohibited without the appropriate license(s) from Microsoft.

Content owners use Microsoft PlayReady™ content access technology to protect their intellectual property, including copyrighted content. This device uses PlayReady technology to access PlayReady-protected content and/or WMDRM-protected content. If the device fails to properly enforce restrictions on content usage, content owners may require Microsoft to revoke the device's ability to consume PlayReady-protected content. Revocation should not affect unprotected content or content protected by other content access technologies. Content owners may require you to upgrade PlayReady to access their content. If you decline an upgrade, you will not be able to access content that requires the upgrade.

---

# CONTENTS

---

Safety Instructions .....	4-5
Trademarks .....	6
Notes about these Operating Instructions .....	8
Wall Mounting and Set Security .....	9
Fitting Wall Bracket Spacers .....	10
TV Control Stick and Input Source Menu .....	11
First Time Installation .....	12-13
Connecting to the Internet .....	14
Applications Menu .....	15
Applications Guide .....	16
TV Menu Operation .....	17-29
Settings Menu .....	17
Quick Settings Menu .....	18
Picture Menu .....	19-20
Sound Menu .....	21
Channel Menu .....	22-23
Network Menu .....	24-25
Time Menu .....	26
System Menu .....	27
About TV .....	28
Media Menu .....	29-31
USB/Media Server .....	29-30
Miracast .....	31
Seven Day Programme Guide .....	32-33
Freeview Play App .....	34
Catch UP TV .....	35-36
USB Recording .....	37
Source Menu .....	38
How to Connect your set .....	39-43
Troubleshooting Guide .....	44-45
Updating Software .....	46
Specifications – USB and DNLA Media Types .....	47-48
Quick Lookup .....	49-50

# OPERATING INSTRUCTIONS ADVICE

When following the guidance on how to use the set, use the following notes. Unless otherwise stated, the remote control is used to operate the set, it will be noted when to use the buttons or control stick on the set itself.

Notes of interest are shown in boxes throughout this manual.

When a menu option is referred to, this will be in **bold**.

The following remote control buttons are used to navigate the menus:

**[EXIT]**: Exits from the menu and returns to the source





**[BACK]**: Takes you one step back in the menu.

**[ARROW BUTTONS]**: Navigate around the options on the screen.

**[OK]**: Selects the option highlighted.

When reference is made to a button to press on the remote control it will be contained within a square bracket like this [OK]. This would mean press the OK button on the remote control.

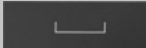
For entering Wi-Fi password information an on-screen keyboard is used. To navigate around this, use the arrow buttons on the remote control, enter the character selected by pressing [OK].

	This button will shift the character set on the keyboard to capital letters.
	Allows the selection of special characters.
	Backspace, deletes last character inputted.
	Insert a space
	Enters password and exits keyboard mode.
	Type of keyboard (ENG is English). This can not be changed.

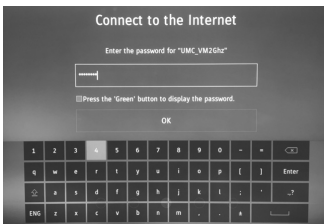

Wi-Fi On Screen Password Entry Keyboard

**Note:** It is not recommended to connect external user interface devices, such as a keyboard or mouse, to this set.



# SECURING THE TV TO A WALL

## Securing the TV to a wall with anti-tip straps

For maximum safety in the home, when using a TV with its stand, anti-tip straps should be fitted. These are available from major retailers & websites and are an easy, inexpensive and effective way of ensuring your TV stays safely upright. Straps are designed to be attached to the rear of the TV and then tethered to the wall or the furniture the TV is stood on, these are fitted as follows.

**A)** Using one or both of the top wall-mounting holes and screws fasten one end of the fastening cord/s to the TV. (the screws are already supplied in the wall mounting holes)

**B)** Secure the other end of the fastening cord/s to your wall. (you will need screws/fixings suitable for your wall type - available separately from most DIY stores).

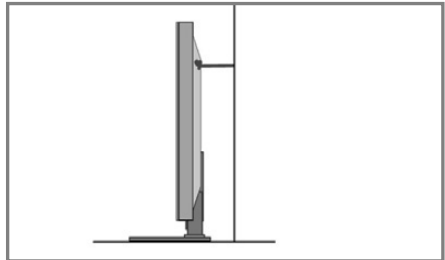
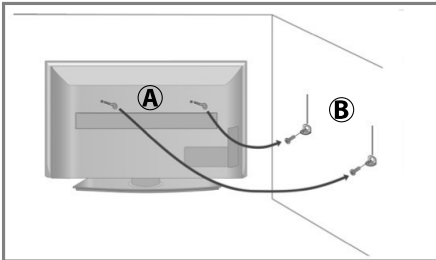

**Note:** Please ensure that children do not climb on or near the TV set.

**Note:** When handling the set do not grip the LCD Panel.

**Note:** Do not pull the set when mounted on a bracket. If using a moveable bracket, adjust via the bracket and not the set.

The Royal Society for the Prevention of Accidents is urging people to take care with flat-screen televisions. RoSPA stated in 2010 that “Toddlers are particularly at risk of pulling flat-screen televisions on to themselves. They are unsteady on their feet and are attracted by colourful television images.” The risk has increased as televisions become lighter.

## Wall mounting

**IMPORTANT** - Before drilling any holes in the wall ensure you are not drilling where there could be electrical wires, water or gas pipes.

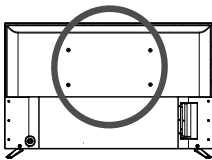

1) Remove the four screws located at the back of the TV set.

2) The wall mount can now be easily attached to the mounting holes, located on the back of the TV, using the same four screws removed.

VESA mounting points are located on the rear of the set, see example above.

For optimum viewing, if wall mounting the TV higher than eye level, the TV should be tilted downwards so that the TV's screen is 'face on'. See fig 1 and 2.

fig 1 INCORRECT

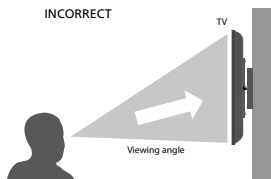
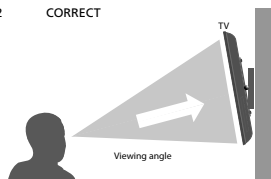

fig 2 CORRECT



**Important:** If wall mounting this TV, only use the screws already provided in the wall mounting holes. Using other screws which are longer could cause irreparable damage to internal parts. When using a wall bracket, please ensure the screws in the back of the TV set are not over tightened.

# SECURING THE TV TO A WALL

When wall mounting the TV, ensure that the mains power cable and any other cables connected to the TV from your external devices do not interfere with your wall bracket. On some models, you will find 'spacers' in the accessories pack that should be fitted in between the rear of the TV and the wall bracket in order to prevent trapping any cables. See Fig 1 below.

4 x Screw including D18 washer

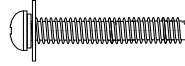

4 x Spacer



These should be used as indicated in the picture below. Ensure that the screws are not overtightened as this may cause damage to the set.

**Note:** the wall bracket type shown in the diagram is for illustration purposes only, other brackets may be used and it is recommended that the spacers and screws are tested to see if they fit correctly before final assembly.

Fig 1.

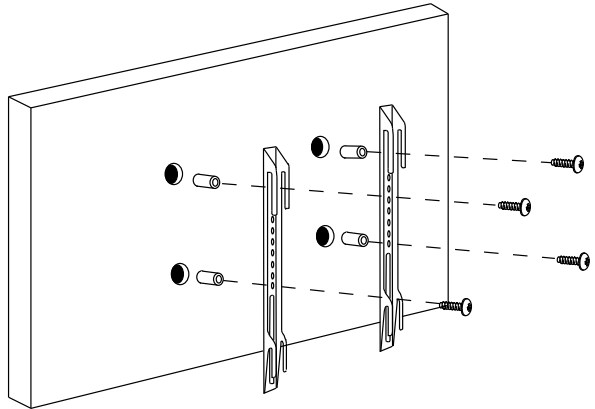

**Important:** Only use the screws provided to mount the set onto a wall bracket. When using a wall bracket, please ensure the screws in the back of the TV set are not over tightened. Failure to use the correct screws may lead to damage.

**Note:** Spacers and screws are not supplied for all models, refer to the Quick Start Guide for more information.

**Note:** Due to the use of rear facing HDMI connectors, right angled HDMI adapters can be utilized to reduce the space required behind the set to allow the cable to bend safely. There are different types of HDMI angled connectors, ensure that the one being used is suitable for the cable/socket types.

# TV CONTROL STICK AND INPUT SOURCE MENU

For models with the joystick type controller.



## TV Control Stick

The TV control stick is located on the back of the TV. The control stick can be used to control many of the TV functions. The shape of the TV's control stick may vary by model.

### While TV is in standby mode:

- Press the centre of the control stick once - Power on the TV set

### While watching TV:

- RIGHT/LEFT – volume up/volume down
- UP/DOWN – changes channel up/down
- Press the centre of the control stick once – displays the menu
- Press and hold the centre of the control stick – Standby/Power Off

### While in menu:

- RIGHT/LEFT/UP/DOWN – navigation of cursor in on-screen menus
- Press the centre of the control stick once – OK/Confirm selected item
- Press and hold the centre of the control stick – back to previous menu

## Choosing Mode Input/Source

Use the source menu to switch between input/connections.

### A) Using the buttons on the remote control:

1. Press [SOURCE] - The 'source' menu will appear.
2. Press [<] or [>] to select the input you require.
3. Press [OK].

### B) Using the TV control stick:

1. Press the centre of the control stick once to enter the TV menu.
2. Press the control stick RIGHT/LEFT and navigate through to 'SOURCE' menu.
3. Press the centre of the control stick to enter the 'SOURCE' menu.
4. Press the control stick RIGHT/LEFT to scroll through and select the input/source you require.
5. Press the centre of the control stick to select the chosen input/source option highlighted.

For further information on input/connections please view the 'Connections' pages.

# FIRST TIME INSTALLATION

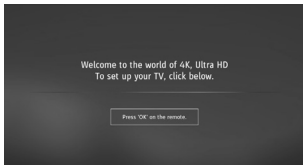

## Introduction

When the set first turns on, it enters the First Time Installation mode. This can be restarted by restoring the set to default settings in the 'ABOUT TV' menu

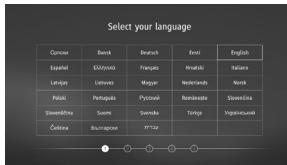

## Languages

Select your preferred on-screen display language. This will change the language in which the menus and associated information is displayed. To change this press the [MENU] button and then select **Settings > System Menu > Language**

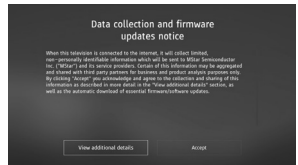

## Agreement 1

Agree to the Data Collection and Firmware update notice.



## Agreement 2

Agree to the manufacturers' Terms of Use. (Only applicable to Freeview Play sets.)



## Country Selection

Select the correct flag for the country in which the set will be used. This will enable the set to correctly install the functions applicable to the country of use.

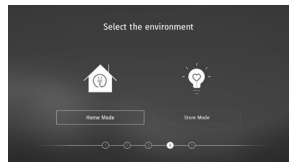

## Environment of Use

**Home Mode:** For normal use, by default, it is set to a power saving mode which reduces the energy used by up to 25% (by reducing the power to the LED/LCD panel). This can be changed in the picture mode settings.



## Network setup

You can connect the TV to your broadband router or wireless network in order to take advantage of the Smart functions. If you connect the TV to your router using an Ethernet cable (recommended) this step will be skipped.



## Select Wi-Fi Network

Select the Wi-Fi network which you would like to be connected to. A padlock symbol next to the network indicates that it will require a password to use.



## Entering Password

Use the arrow buttons on the remote control to select the correct character and then press [OK] to enter. Press the [GREEN] button to reveal the password.

# FIRST TIME INSTALLATION



## Confirmation of Internet Connection

If the network has been correctly authorised, a tick symbol will appear next to it.



## Set Up Netflix

If you have a Netflix account, it can be set up on the television here. Once set up and validated, the First Time Installation continues on to the next step.

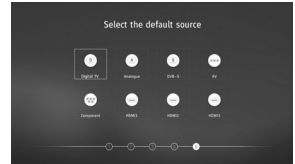

## Default Source

Select the source which you use the most. If Digital TV (Freeview) is chosen, then at the next step, the set will tune in and default to Digital TV (Freeview). If one of the other sources is selected, then the set will not tune in at this stage and default to that input. To change this press the [MENU] button and then select **Settings > Channel**

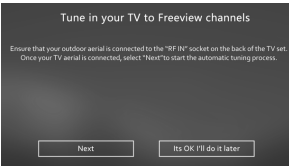

## Tune in Channels

Chose to install terrestrial channels now or later.

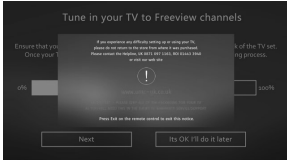

## Support Advice

Information regarding support is displayed.



## Tuning Progress Indication

Tuning continues and a progress bar is shown with the number of channels found indicated below this.



## Country Selection

When Digital tuning is complete, select your country of use. Normally this will only show one country, unless you are receiving channels from multiple transmitters in other countries.



## Primary Region Selection

Select the region that you would like to receive your local news from.



## Secondary Region Selection

Select your nearest or strongest signal transmitter.

**NOTE:** These screens only come up if more than one region is found. i.e. two or more transmitters are tuned in.

### Note:

**In Home Mode,** the TV will switch itself to the standby mode after 4 hours in the event that the buttons on the remote control or TV set are not used. This can be disabled in the 'TIME' menu.

**Store Mode:** For store display use. The picture is adjusted to optimum settings. The store demonstration will appear on the screen automatically after two minutes.

# CONNECTING TO THE INTERNET

When you first power on your new SMART TV there will be an option to follow various on-screen set up instructions. These instructions will enable you to connect to the internet via your home network. You can connect to your home network either wirelessly or with an Ethernet cable.

If you decide not to follow the initial set up instructions and need to connect at a later date please follow these simple steps below:

### **Connecting your TV: Wireless Connection**

Enter the '**Network**' menu and ensure that Wi-Fi is selected. Move to Wi-Fi and press [OK] on the remote control. This will bring up any local Wi-Fi networks, choose the desired network and connect. If a password is required a prompt and a keyboard to enter it will be displayed.

### **Connecting your TV: Ethernet/LAN cable**

Plug your Ethernet cable into the RJ45 (Ethernet) socket located at the rear of the television.

# APPLICATIONS MENU

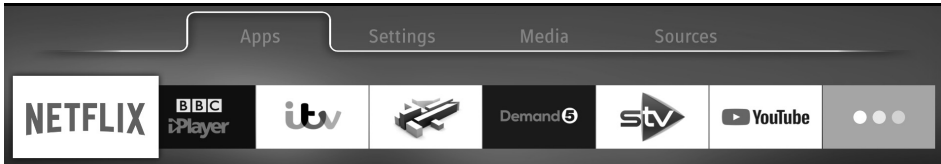

**Note:** The position of apps may vary depending on your TV set.

**Note:** The applications available will be different depending if the set is a Freeview Play model. Refer to the application list.

The '**Application**' menu allows you to access the TV set's "SMART" features. In this menu you can enter various functions including Web Browser, BBC iPlayer, etc. At the bottom of the screen there are some key apps for easy and quick access.

To view the next layer of the '**App**' menu, scroll right and select:



**Note:** HDR is supported on apps such as Netflix and YouTube, and only works if the data being streamed contains HDR data.

## Aquos Net+

# SMART TV

## AQUOS **NET+**

Aquos Net+ is a portal which allows access to a variety of apps and multimedia services which the TV can access via the internet. To enter Aquos Net+ you will be prompted to enter a language and accept terms and conditions. Once the relevant information has been entered you will be able to use a range of features such as MUZU.TV, Viewster and Dailymotion.

Content is updated and managed from a central source, so look out for new features and updates.

# APPLICATIONS GUIDE

Applications Available on Freeview Play Models	
Netflix	Allows access to films, boxsets and other streaming videos via your Netflix account. Note that you will have to set up your own Netflix account to access this application as subscription is not included with the set.
BBC iPlayer	Enjoy BBC iPlayer exclusives and your favourite BBC programmes from the last 30 days.
YouTube	Video sharing website allows you to discover, watch and share originally created videos.
BBC News	Access the BBC News app for up-to-the-minute and breaking news reports.
BBC Sport	The BBC Sport app offers the latest sports news, live action and scores.
Aquos Net+ Portal	More applications.
ITV Player	The ITV Hub, new home of ITV on demand. Enjoy the best telly anytime, anywhere.
Channel 4 (All 4)	The latest "Catch Up" plus a huge library of shows from 4, which includes complete box sets.
Demand 5	Watch full episodes of your favourite Channel 5 programmes when it suits you.
UK Play TV	"Catch Up" on your favourite Dave, Really, Yesterday and Drama shows with Freeview Play Access the Freeview Play app. Please see the ' <b>FREEVIEW PLAY</b> ' App page for further information.

Applications Available on Non-Freeview Play Models	
Netflix	Allows access to films, boxsets and other streaming videos via your Netflix account. Note that you will have to set up your own Netflix account to access this application as subscription is not included with the set.
BBC iPlayer	Enjoy BBC iPlayer exclusives and your favourite BBC programmes from the last 30 days.
YouTube	Video sharing website allows you to discover, watch and share originally created videos.
BBC News	Access the BBC News app for up-to-the-minute and breaking news reports.
BBC Sport	The BBC Sport app offers the latest sports news, live action and scores.
Aquos Net+ Portal	More applications.

Web Browser	Application for accessing websites via the internet. Use the following buttons for navigation in the browser:
CH+	Scroll page up
CH-	Scroll page down
Red Button	Show/hide browser menu bar
Yellow Button	Zoom in
Blue Button	Zoom out

**Note:** Some Apps, such as Netflix, require a monthly subscription. This is not included with the purchase of your TV set.

**Note:** The appearance and functionality of apps may vary depending upon the revision of the app and the platform it is designed to be used on. On-demand players may also change depending upon the region in which the set is tuned into.



# SETTINGS MENU

In this area, you can adjust your television to your preferred settings. Refer to the next pages to correctly set up your Sharp television to your preferred settings.

To enter the 'Settings' menu press the [MENU] button followed by [UP], then scroll to the settings option by using the [RIGHT] arrow key.

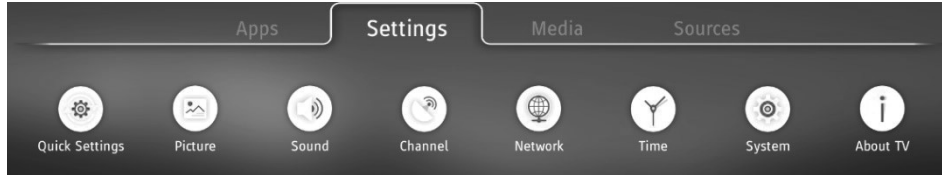

Quick Settings		Allows you to quickly access some of the most useful functions on the set.
Picture		Enables control of the picture settings to ensure optimal performance and personal preference settings to be stored.
Sound		Controls the individual sound settings on the television.
Channel		Set up your channels and tuning.
Network		Connection to your Wi-Fi or Ethernet network.
Time		Gives control over all the time and date functions on the set.
System		Provides access to the overall system controls within the television.
About TV		Shows relevant information about the set and its functions.



# QUICK SETTINGS MENU

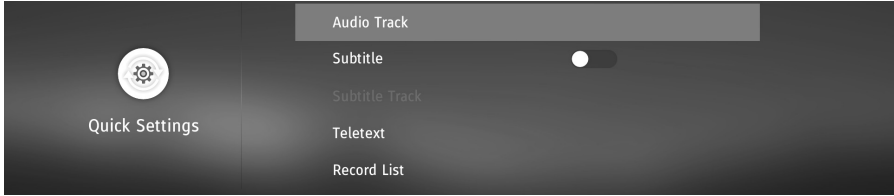

This menu allows you to quickly access the most popular functions on the set without having to navigate through the various menus.

Audio Track	Allows you to choose between the audio channels being transmitted on Digital Television. Currently for Freeview only normal sound or the Audio Description audio channels can be selected.
Subtitle	Turn subtitles on and off. Subtitles can also be turned on and off by using the [Subtitle] button on the remote control.
Subtitle Track	Appears when Subtitles (above) are turned on and allows you to select which subtitle track is to be used. There may be more than one sub-title available for use, i.e. English Subtitle or Hearing Impaired subtitle.
Teletext	Turn Teletext on or off. This can also be achieved by pressing the [Teletext] button on the remote control.
Record List	Shows a list of recorded TV programmes via a connected USB memory stick or USB hard drive. While in the 'Recorded List', press the [BLUE] button to access the 'Schedule List'. Refer to the 'USB RECORD' page for further information.
Schedule List	The schedule list allows you to view your reminders and recordings. There are two icons, the clock symbol denotes a reminder, the camera indicates a recording. To select use the [UP] and [DOWN] arrow buttons.

## Playback files from Record list

To playback recorded files you will be required to have the TV set to the Freeview/Saorview source mode. Once set to the correct source, access the recorded list by pressing the [REC LIST] (Recorded List) button on the remote control or select the record list from the 'Quick' menu, the Recorded List should now appear on the screen. Use the arrow buttons on the remote control to navigate to the recording you wish to playback and then press [OK] on the chosen file to start playback.

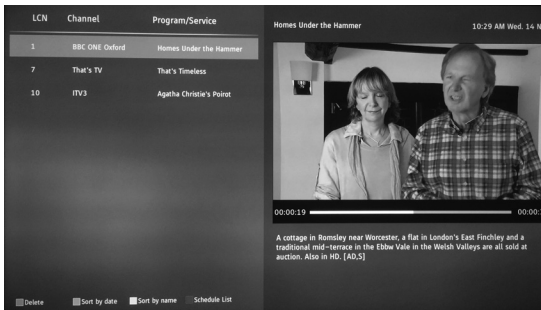

Use the coloured buttons on the remote control for the following options:

- Press [RED] to delete a selected recording.
- Press [GREEN] to sort the items in the record list by date.
- Press [YELLOW] to sort the items in the record list by name.
- Press [BLUE] to enter the schedule list.

**Note:** Recording is only possible when a USB stick is plugged in and formatted at FAT32. Visit the 'USB RECORDING' page for more information.



# PICTURE MENU

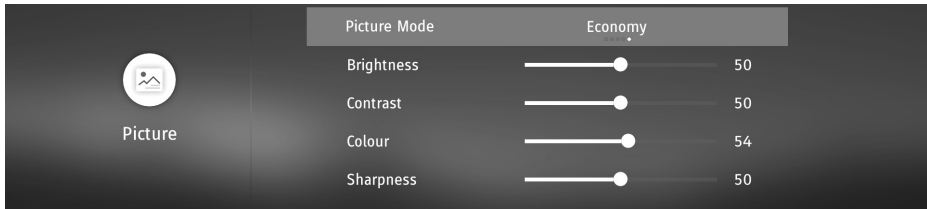

For complete control of your picture settings, enter the **'Picture'** menu to set up the following adjustments. These will allow you to enhance your viewing experience and utilise the full capability of the television.

## Picture Mode

To enable fast setting of the desired picture performance the following options can be selected by pressing the [PICTURE] button on the remote control:

Economy	Power saving mode which reduces the energy used by up to 25% (by reducing the power to the LED/LCD panel). In Economy mode, the TV will switch itself to Standby mode after 3-5 hours in the event that the TV buttons or remote control buttons are not pressed (change the picture mode to another setting to de-activate this function) In the economy mode the brightness of the picture may be reduced.
Standard	Standard settings
Personal	Allows you to change the picture settings to your personal preference. These settings are saved automatically.
Dynamic	Recommended settings for fast moving pictures.
Movie	Picture has less colour and is darker.

You can make the following adjustments in **Personal** mode:

Brightness	Increase or decrease the brightness of the picture.	Range: 0-100								
Contrast	Switch the balance between black and white.	Range: 0-100								
Colour	Changes the picture between colour and black and white.	Range: 0-100								
Sharpness	Increase or decrease the sharpness of the picture.	Range: 0-100								
Colour Temperature	Choose from the following: <table border="1" data-bbox="336 1133 784 1276"> <tr> <td>Standard</td> <td>Default settings.</td> </tr> <tr> <td>Warm</td> <td>Increases red within the picture.</td> </tr> <tr> <td>Personal</td> <td>Your own settings.</td> </tr> <tr> <td>Cold</td> <td>Increases blue within the picture.</td> </tr> </table>	Standard	Default settings.	Warm	Increases red within the picture.	Personal	Your own settings.	Cold	Increases blue within the picture.	
Standard	Default settings.									
Warm	Increases red within the picture.									
Personal	Your own settings.									
Cold	Increases blue within the picture.									



**Aspect Ratio** - Within the UK the picture format varies depending on the channel/broadcast. There are a number of different options to best meet your needs;

- Auto
- 16:9
- 4:3
- Zoom 1
- Zoom 2

### Auto

Automatically displays the best picture format so the picture is in the correct position. Black lines may appear at the top/bottom and/or sides.

### Full Screen

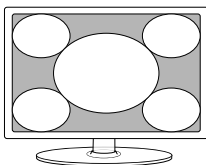

Displays a picture in the full screen mode without overscan. 16:9 signal will be displayed in original proportion. Other picture format will be stretched to fill the screen

### Dot by Dot

Will display the picture in its original resolution without any change, only available in HDMI input source

### 16:9

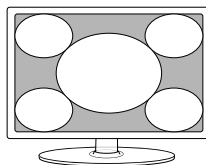

Fills the screen with a regular 16:9 signal and 4:3 picture format will be stretched to fill the screen

### 4:3

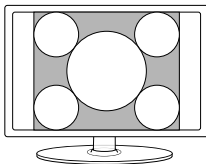

Displays the 4:3 picture in its original size. Side bars are shown to fill the 16:9 screen

### Zoom1 and Zoom2

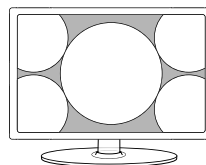

The picture is the correct proportion but zoomed in to fill the screen

## Expert Settings

Use these adjustment settings to improve the picture in more detail.



Noise Reduction	Off, Low, Medium, High.	
Gamma	Changes the range of the colour reproduction. Low, Medium and High.	
Active Contrast	Allows for the contrast level to be adjusted automatically depending on picture content. 'ON' or 'OFF'.	
Backlight	Switches optimization of the backlight and contrast of the picture.	Range: 1-100
Red	Adjust the amount of red in the picture.	Range: 1-100
Green	Adjust the amount of green in the picture.	Range: 1-100
Blue	Adjust the amount of blue in the picture.	Range: 1-100
CMS Hue	This is a standard to adjust the colour either more reddish or more bluish in tone. R/G/B/C/M	Range: -63 to 63
CMS Value	A higher value makes the image brighter. A lower value makes the image darker. R/G/B/C/M	Range: -32 to 31
CMS Saturation	Increases or decreases the saturation of a selected colour. R/G/B/C/M	Range: 0 to 15

# SOUND MENU

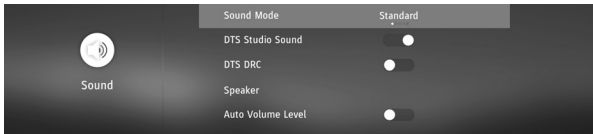

For complete control of your audio settings, enter the 'Sound' menu to set up the following adjustments. These will allow you to enhance your listening experience and expand the full capability of the television.

**Sound Mode** - To enable fast setting of the desired sound mode one of the following options can be selected by pressing the [SOUND] button on the remote control:

Standard	Default settings
Music	Emphasises music over voices
Movie	Provides live and full sound for movies
Sports	Emphasises sound for sports
Personal	Allows you to change the sound settings to your personal preference. These settings are saved automatically.

**DTS Studio Sound**- Choose from the following options:

Off	Disables the DTS Studio Sound audio feature
On	Studio Sound creates an immersive, feature-rich surround sound experience from two speakers, complete with rich bass, high frequency detail and clear dialog.

**DTS DRC (Dynamic Range Control)**-

OFF	Disables the DTS DRC feature.
ON	Adjusts the level of dynamic range for DTS movie soundtracks. Very loud sounds get quieter and quiet parts get louder. Recommended for midnight listening.

**Speaker** -

Digital Audio Output	Switch between Auto, PCM or RAW.	
Digital Audio Delay	Delay the sound in relation to the picture on the digital output.	
Audio Delay (ms)	Delay the sound in relation to the picture on the audio output (speaker, headphone, etc.)	Range: 0 - 250.

**Auto Volume Level** -

ON	When 'ON' is selected, the volume will attempt to stay at a constant level regardless of TV programme and advertisements.
OFF	Switches Auto Volume off.

**Expert Settings** -

Balance	To switch the sound between the left and right speakers.	Range: -50 to 50.				
Equalizer Function	Enables you to adjust the frequency characteristic of the sound output for the following ranges: 100Hz, 500Hz, 1.5kHz, 5kHz, 10kHz.	Range: -10 to 10.				
Audio Description	Allows you to switch Audio Description 'ON' or 'OFF'. This provides a description of what is happening during the selected programme for a person who is visually impaired. This feature is not available on all programmes.					
	<table border="1"> <tr> <td>ON</td> <td>Switches Audio description on. AD Volume Control is activated.</td> </tr> <tr> <td>OFF</td> <td>Switches Audio Description off.</td> </tr> </table>	ON	Switches Audio description on. AD Volume Control is activated.	OFF	Switches Audio Description off.	
ON	Switches Audio description on. AD Volume Control is activated.					
OFF	Switches Audio Description off.					



For DTS patents, see <http://patents.dts.com>. Manufactured under license from DTS Licensing Limited. DTS, the Symbol, DTS and the Symbol together, and DTS Studio Sound are registered trademarks and/or trademarks of DTS, Inc. in the United States and/or other countries. © DTS, Inc. All Rights Reserved.



# CHANNEL MENU

Use of the 'Channel' menu allows for setting the TV up to receive incoming aerial signals.

Note that this menu will change depending on which aerial source is being used. These options include:

- Terrestrial Digital Television
- Cable Digital Television
- Satellite Digital Television
- Analogue Television



DVB Antenna	Selected input antenna type.
Auto Scan	Allows you to retune the television for all digital channels, digital radio stations and analogue devices.
Tuning Mode	Digital, Analogue and Digital + Analogue.
Auto Tuning	When selected, the set will start tuning.
Digital Manual Tuning	Allows you to manually tune your digital signal by selecting the channel number. Press [OK] to start.
Digital Smart Retuning	Enables the set to retune those channels already stored.
Auto Update Channel List	Can be set to "ON" or "OFF".
HbbTV	Allows interactive services like BBC red button+ using Digital TV broadcasting when connected to the internet.
LCN	Logical Channel Number. When turned on, digital stations will be in order.
Standby Scan	When the TV is put into standby mode a standby scan will be performed, during this process the TV will scan for new channel information and automatically update the channel list if any changes are found, both the visual and audio functions will be off, once the scan is complete the TV will stay in standby mode.
CI Information	Pay per view services require a "Smartcard" to be inserted into the TV. If you subscribe to a pay per view service the provider will issue you with a 'CAM' and a "Smartcard". The 'CAM' can then be inserted into the COMMON INTERFACE PORT (CI Card In).

**Important:** To receive Freeview/Saorview channels, in particular HD channels, you will need a Digital TV aerial and be in a good Freeview/Saorview coverage area. You can check the coverage for your area at [www.freeview.co.uk](http://www.freeview.co.uk) or [www.saorview.ie](http://www.saorview.ie)

**Note:** Any Freeview HD channels found during tuning will be placed in channel positions above 100. For example, 101 (BBC1 HD) 102 (BBC2 HD) etc.

**Note:** Freeview channels are only available in the UK, Saorview channels are only available in the ROI.



## Signal Information

Allows you to view signal frequency, signal quality and signal strength.

**Quality** - How good the signal is.

**Strength** - How strong the signal is.

If the signal is strong, but the quality is low, there will be reception issues.

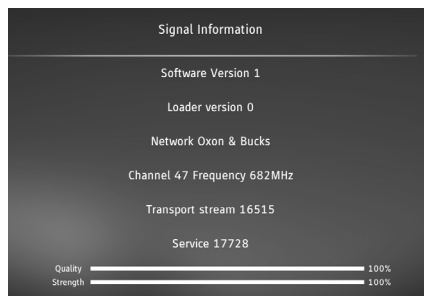

## Analogue Tuning

When the source is changed to Analogue, the tuning menu will have the following options:

Auto Scan	Allow the set to tune automatically into analogue stations.
Analogue Manual Tuning	Direct tuning of analogue stations.

## Satellite Tuning

When the source is changed to Satellite, the tuning menu will have the following options:

Satellite Tuning:	
Antenna Setup	Type of reception being received.
Channel Type	Allows only all channels, locked channels or free channels to be selected. Options are Free+Scramble, Scramble, Free
Service Type	All, Radio or DTV.
Scan Mode	Default, Network Scan or Blind Scan.
Auto Tune	Tunes the set automatically.
Auto Update Channel List	Enables the set to re-tune those channels already stored.
HbbTV	Allows interactive services using Digital TV broadcasting when connected to the internet.
LCN	Logical Channel Number. When turned on, digital stations will be in order.
CI Information	Pay per view services require a "Smartcard" to be inserted into the TV. If you subscribe to a pay per view service the provider will issue you with a 'CAM' and a "Smartcard". The 'CAM' can then be inserted into the COMMON INTERFACE PORT (CI Card In).
Signal Information	Will show the condition of the received satellite signal.

**Note:** If channels are tuned in on satellite, other tuning modes are not possible.



# NETWORK MENU

Set up and control your network and internet access here.

There are two ways to connect to your local network, in most cases this will be the router used to connect to the internet.

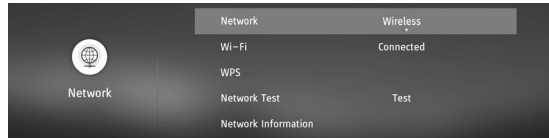

The following options are available for both Wi-Fi and wired connections in the **'Network'** menu.

Network	Select the type of network connection – Ethernet (Cable) or Wi-Fi (Wireless).
Network Test	Allows the network connectivity to be tested.
Network Information	Gives information about your network.

When **Wi-Fi** is selected, the options below are shown in the menu:

Wi-Fi	This advises the connection status of the Wi-Fi network. If [OK] is pressed, another menu opens which shows all Wi-Fi networks which the set can detect. Select the one which you want to connect to and press [OK]. If the network is locked, the screen will now show a password entry screen with an on-screen keyboard. Select 'Refresh' to update list of available networks.
-------	--

Use the arrow buttons to select the character required.

Pressing the [GREEN] button will display the password; this is defaulted to show "\*" for security.

Capitals are selected by pressing caps key  on the on-screen keyboard.

Special characters can be selected using “.,?” keyboard button.

Once password is entered, select Enter and press [OK]. Then select OK (on screen) and [OK] on remote. Tick appears next to network if connected.

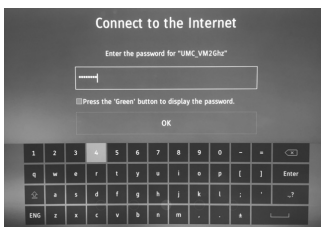

**On screen password entry keyboard.**

**WPS:** Select and press WPS button on router

Push Button Method	Select and requests to press button on router
Generate Security PIN	Select and PIN generated for router.

When **Ethernet** is selected, the options below are shown in the menu:

Ethernet	This advises the connection status of the wired (Ethernet) network. If [OK] is pressed, another menu opens which allows for the connection to an IPv4 or IPv6 wired network:
----------	--





# NETWORK MENU

## IPv4

Auto	This is also known as DHCP, use this setting to automatically set the IP address of your television via the router.
Manual	Manually set press [OK] when on function and then use arrow keys to manually edit setting.
IP	Set the IP address.
Netmask	Set the Netmask address.
Gateway	Set the Gateway address.
DNS	Set the DNS address.
OK	Press to enter options selected.
Disabled	Disable IPv4.

## IPv6

Auto	This is also known as DHCP, use this setting to automatically set the IP address of your television via the router.
Manual	Press [OK] to edit, keypad is displayed to enter data. When finished select 'enter' and press [OK].
IP	Set the IP address.
Prefix	Adjust in the range 1 to 128 using the RIGHT/LEFT arrow buttons.
Gateway	Set the Gateway address.
DNS	Set the DNS address.
OK	Press to enter options selected.
Disabled	Disable IPv6.



# TIME MENU

Any time related function can be set or seen here.

Time	12:36 PM Wed. 14 Nov
On Time	
Off Time	
Sleep Timer	
Auto Standby	4 H

When the time is selected using the [UP/DOWN] arrow buttons and [OK] is pressed, the following options appear:

Time:	
Auto Sync	Turn on to synchronise the time to the incoming digital television signal. If connected to the internet, the clock will be updated from here. Turn off to set the clock manually.
Time Zone	Adjustment of the time offset. Use the [UP/DOWN] arrow buttons on the remote control to change the setting.
Daylight Savings	Cannot be set in Freeview mode as this information is taken from the Freeview transmission. Allows 1 hour offset from GMT.

On Time	Allows you to set a specific time for your TV to turn on, the channel it will then display, the source it will be on and also the volume. This function can then be toggled to repeat every day or a certain day. If your set is in standby and the on time is reached, it will turn on.	
	On time	Allows you to set a specific time for your TV to turn on. Use arrow buttons to select the option and [OK] to set.
	Input Source	Select the source which the television should turn on and display.
	Digital Channel Type	Only applicable for DTV. TV, Radio or Data can be selected.
	Channel	Use the [RIGHT/LEFT] arrow buttons to select number.
	Volume	Sets volume which the set comes on at.
Off Time	Allows you to set a specific time for your TV to turn off. Use arrow buttons to select the option and [OK] to set.	
Sleep Timer	Lets you set the sleep timer so the television automatically switches off after a set amount of time. Options are; Off, 15min, 30min, 45min, 60min, 90min, 120min or 240min.	
Auto standby	Controls the amount of time the set will continue to operate without any buttons being pressed on the set or remote control before going into standby. Options are OFF, 3 hours, 4 hours or 5 hours.	
OSD Timer	Lets you adjust the amount of time the on-screen Menu stays on before disappearing. Option are; Never, 10S, 20S, 30S or 60S. (S = Seconds.)	



# SYSTEM MENU

Set up system control options in this menu.

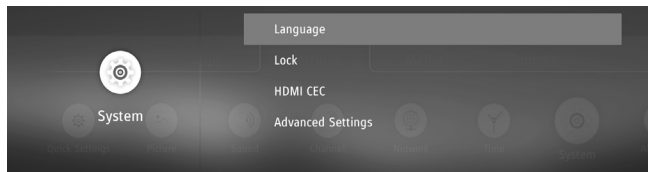

## Language

Set your preferred languages.

Menu Language	Set the language used in the on-screen display, menus etc.
Primary Audio Language	Set the audio track for Digital Television
Primary Subtitle Language	Set the on-screen subtitle language.

**Note: Only languages which are being transmitted can be selected.**

## Lock

Lock	Set the lock function on your set.
Set Password	Set the audio track for Digital Television
Channel Lock	Set the on-screen subtitle language.
Parental Guidance	Set the parental guidance level.
The default password is "0000"	

## HDMI CEC

Set up the HDMI functionality of the set

CEC Control	Turn on or off.
Device Auto Power Off	Enable automatic device power off when television turns off.
TV Auto Power On	Enable television turning on from standby when HDMI source powers up.
HDMI ARC	Turn ARC functionality on or off. ARC (Audio Return Channel) allows sound to be outputted via the HDMI connection. This can be fed into an audio device for an enhanced listening experience.
HDMI 2.0 Format Standard	Can only be selected when on HDMI input.
Detect	Show list of connected HDMI devices.

## Advanced Settings

Source Re-name	You can re-name each source to your desired name.	
Expert Settings:		
PVR & Time-shift Settings:	(PVR settings are only visible when USB stick is plugged in.)	
	Disk	Displays the USB device.
	Select Partition	Shows the partition being used.
	Timeshift	Amount of memory allocated to time shifting – 512MB, 1GB, 2GB or 4GB.
	Format	Format the connected device.
	Speed Check	Check that the speed of the connected memory is okay.
Hearing Impaired	Enhanced subtitles used if transmitted.	
Network Wake Up	Allows the set to turn on via network control.	
Store Mode	Turn the store mode on or off. Selecting this mode will disable the economy mode and bring up functions on specification on screen display after 30 seconds of use.	

# ABOUT TV

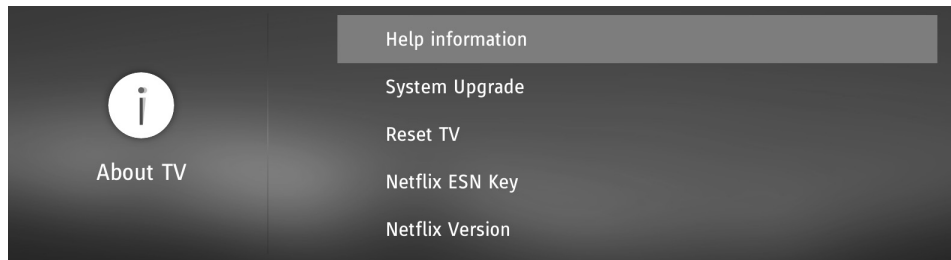

Help Information	Shows the set name and software version.	
	Model	Model number of your set.
	Software Version	Date of the software revision” to “Displays the software revision number and the date/time of revision.
	Helpline Tel. Number	Your Sharp Helpline telephone number.
	Email Address	Your Sharp Helpline email address.
	Website	Sharp website.
	Online Manual	View the online Operating Instructions.
System Upgrade	Allows you to update your set.	
	Software Update (USB)	Update the set
	OAD	Initiate an Over Air Download
	OAD Scan	Scan for an Over Air Download
	Internet Update Check	Check for a network update.
	NetReady Information	NetReady allows control of OTA updates.
Reset TV	Restore the television.	
Netflix ESN Key	Shows the Netflix ESN Key code.	
Netflix Version	Version of Netflix software.	
Netflix Deactivate	Deactivate Netflix on this set.	
Netflix Terminate	Delete Netflix login information on this set.	
View End User Licence	Shows the End User Licence.	

# MEDIA MENU

Select other input data source from this menu:

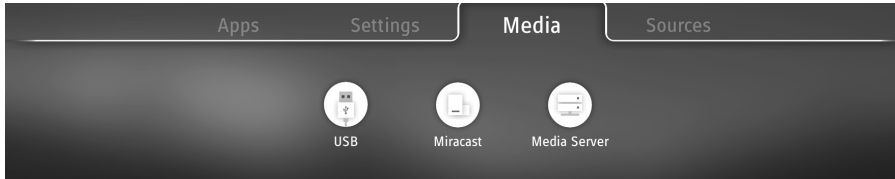

### USB and Media Server

The USB media and the Media Server offer the playback of various different types of content that is either saved on your USB memory stick or external media server. (USB mode allows you to view/playback files from an external USB device and Media Server connects to your home network and can view/playback files from your compatible laptop, PC, tablets and smart phones).

When accessing the USB media or media server features the below menu screen will appear. The content will be divided into Photo, Music, Movie and All.

**Note:** If you experience a playback issue, please ensure the files being used are the correct format (example - the picture plays but no sound) See the 'Compatible file types for USB playback' section at the rear of these Operating Instructions.

1) You can navigate through the menus using the [ARROW BUTTONS] on the remote control, to confirm the item you wish to play/view press the [OK] button (the USB1 and USB2 options will only show when a USB stick is connected).

2) USB mode - Select the USB drive (If your drive only has 1 partition you will only see 1 item).

Media Server - Select the external device that you would like to access. You can now access the item. Press [OK] to view.

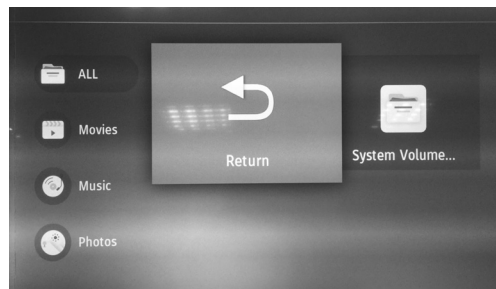



3) Whilst viewing your media, you can control the item by using the remote control playback buttons or by pressing [INFO] you can access the on-screen playback menu, you can now make your selection by using the [ARROW BUTTONS] and [OK] buttons on the remote control.

**Note:** If you experience a playback issue, please ensure the files being used are the correct format (example - the picture plays but no sound). See compatible file types for USB/DLNA page for compatible file types.

**Note:** USB extension cables are not recommended as they can cause a reduction in picture/audio quality and stoppages during play back of USB content.

# MEDIA MENU

## Miracast (Screen mirroring)

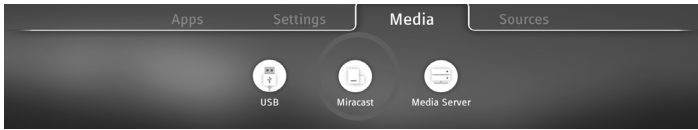

To access this menu, press [MENU] button on the remote control and scroll right.  
To select a sub menu press [OK]

If you wish to make changes to any of the default settings, use the scroll buttons.  
To confirm any settings press [OK] button. To exit this menu at any time, press [EXIT] button.

Although the TV has many of the most popular Apps preinstalled, the Miracast function allows almost unlimited Apps to be shown on the TV screen including many on demand videos, subscription based services and your favourite applications such as Emails and Facebook.

The Miracast (screen mirroring) feature allows you to connect to a compatible Smartphone, Tablet, PC or Laptop wirelessly and 'mirror' what is on your device onto the TV's screen.

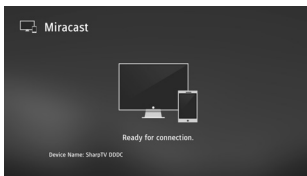

See below an example of a connection to a Laptop PC running Windows 10 that has built in Wireless Display.

For connection to other types of devices please refer to the instruction manual that came with your device.

Click on the monitor icon (circled below) to access this feature.

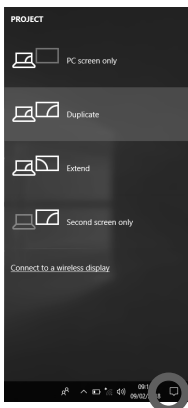

Once you're connected, you will see this screen on your Laptop/PC.

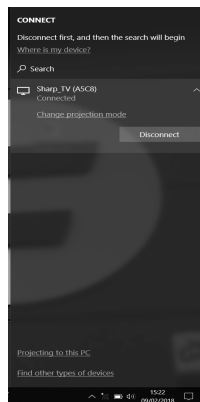

Once a successful connection is made, your TV will display this screen.

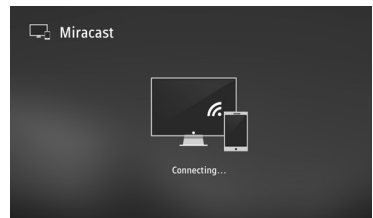

**Note:** Many Android and Windows devices support screen mirroring. For Apple devices, you need a separate Apple TV box to allow screen mirroring onto non Apple products.

**Note:** If your smartphone or tablet does not include mirroring, it may be possible to connect a suitable cable from your device directly to one of the HDMI inputs on the rear of the TV. Suitable cables for your device should be available from a local electronics retailer.

# 7 DAY TV GUIDE AND CHANNEL LIST (Freeview Play)

TV Guide is available in Saorview/Freeview TV mode. It provides information about forthcoming programmes (where supported by the Saorview/Freeview channel). You can view the start and end time of all programmes and on all channels for the next 7 days and set reminders.

1) Press the [TV GUIDE] button on the remote control and the following 7 Day TV Guide will appear:

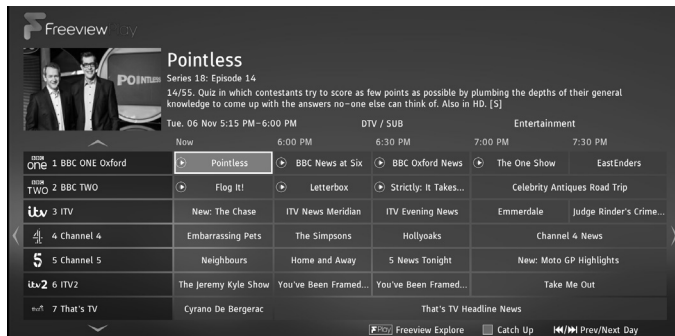

- To be recorded on Catch Up.



- Already recorded on Catch Up.

Catch Up is only applicable to sets with Freeview Play.

**Note:** Freeview HD channels found during tuning will be placed in channel positions above 100, for example, 101 - BBC 1 HD, 102 - BBC 2 HD etc.

2) Navigate through the menu using the [ARROW BUTTONS].

You can now:

Press [INFO ] to view further information about the programme highlighted.

Press the [FREEVIEW PLAY] button to access the Freeview Play app. Refer to the 'Catch Up' menu page for further information.

Press the [INFO] button on a highlighted programme to use the record function. (Function for PVR models only, USB device must be connected):

3) Press [EXIT] to exit the 7 day TV Guide

### Setting Recordings and Schedule Reminders

While in the Programme Guide, it is possible to Record a programme or set a reminder. Use the arrow keys on the remote control to select the programme you would like to record or set a reminder for and then press the [OK] button. This will bring up the menu as shown below:

Select one of the Options	Watch Now	Only applicable when the play symbol shows up, will play back via the on-demand player.
Watch Now	More Details	View further information about the programme highlighted.
More Details	Record	Will allow you to set a recording for this time.
Record	Reminder	Will allow you to set a reminder for this time.
Remind		



Watch now will only appear if the symbol  appears on the programme name. This means that it has already been recorded by an on-demand player. When selected the programme will playback using the on-demand player for the channel.



## To Record a Television Programme

To record a programme, select 'Record' and the display will change as shown on the right. This allows for the time and frequency of the recording to be set as desired. Once adjustments to the time and frequency have been set, save the instruction. This will now appear in the schedule list as a recording to be made.

If a current programme is set for recording, the start time will be set a minute in the future to allow settings to be made and saved.

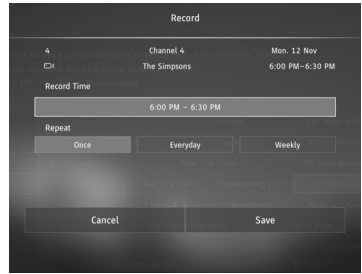

## To Set a Reminder for a Television Programme

To set a reminder, select "Remind" and the display will change as shown on the right. This allows for the time and frequency of the reminder to be set as desired. Once adjustments to the time and frequency have been set, save the instruction. This will now appear in the schedule list as reminder

Reminders cannot be set for programmes currently being transmitted.

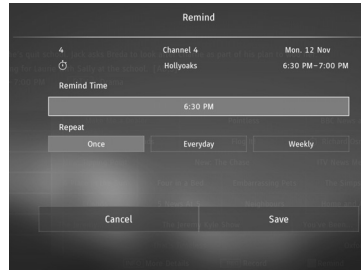

To view the list of scheduled reminders go to Quick Settings and select Schedule List, the screen to the right will be shown. This will indicate which reminders have been set and when. Press the [MENU] button to edit.

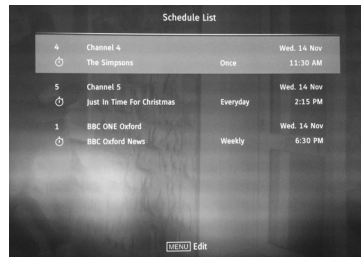

## Non-Freeview Play 7 Day Guide

Non-Freeview Play models will display the Programme Guide as shown below.



**Note:** Record functions are only applicable to sets with a built in USB Record/PVR function.

**Note:** When the TV set is on, a reminder message will be displayed informing you that a programme is about to start. If the set is in standby, then it will turn on at the reminder time.

**Note:** When recording in standby mode, the set will not turn on. While recording in standby, the light on the front of the set will flash.

# FREEVIEW PLAY APP

Only applicable to sets with Freeview Play.

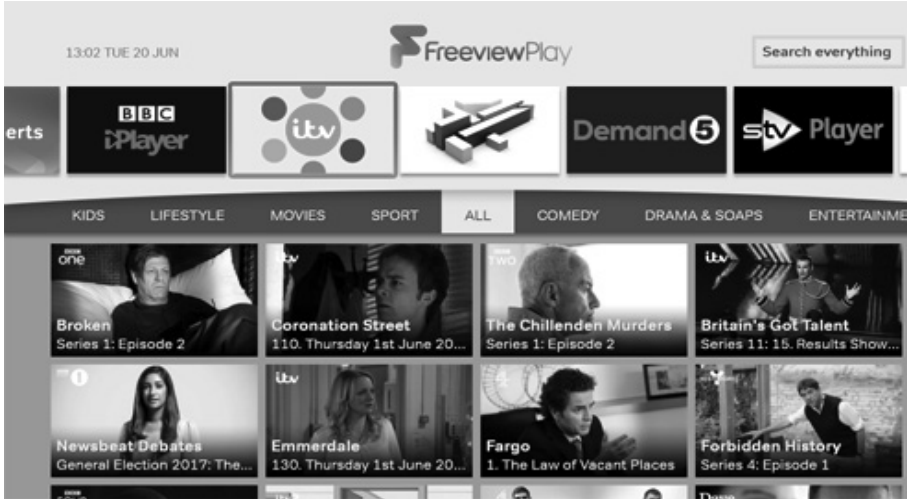

When in the Freeview Play application, it is possible to search for a programme by name. Choose the “Search everything” option and then use the on-screen keyboard to type in the programme name. As you type, selections will appear. Select one of these options to start watching.

**Note:** To use the full functionality of Freeview Play your set must be connected to the internet.

Freeview Play brings together live TV viewing with “catch up” TV services from broadcasters such as BBC, ITV, Channel 4 and Channel 5. The Freeview Play Explore app features a carousel of genres to select from when searching for programmes, such as sport, comedy, dramas & soaps, etc. Content is made up from recommendations of the major broadcasters and offers an alternative means of searching.

To access Freeview Play simply press the [FREEVIEW PLAY] button on your remote control (fig1). Freeview Play can also be accessed via the ‘7 Day TV guide’ menu and the ‘Apps’ menu. When you first access Freeview Play you will need to accept the Terms of use simply select ‘OK’ to confirm. Once selected the Freeview Play on demand apps will appear on the screen. Use the buttons on the remote control to select your chosen app and press OK.

**Note:** Some apps require additional registration, this is a simple process and it will inform you of the correct website to visit to complete the registration.

Areas receiving Saorview transmissions will not support Freeview Play or Freeview Play services.



Picture is for illustration only, actual remote control may be different.

# CATCH UP TV

Only applicable to sets with Freeview Play.

The 'Catch Up' menu allows you to access available programmes from the last 7 days, that you may have missed.

The 'Catch Up' menu will show programmes, by day, in the order that they were broadcast (descending in time order).

On the right there is a channel list, move through this to see the programmes applicable to that channel. View more information on the highlighted programme by pressing the [INFO] button.

**Note:** Areas receiving Saorview transmissions will not support catch up services.

1) To access the 'Catch Up' menu, first you will need to access the 7 day TV guide, access this by pressing the [TV GUIDE] button on the remote control, when the 7 day TV guide appears press the [RED] button or scroll left to access the catch up menu screen

2) You can navigate through the menu using the [ARROW BUTTONS] on the remote control. To play a highlighted programme simply press [OK] on the remote control. By pressing [BACK] or [EXIT] on the remote control will take you back to the 'Catch Up' menu. Pressing [BACK] or [EXIT] again takes you out of the programme guide and back to standard TV.

Whilst in the 'Catch Up' menu you can also

- Access the Freeview play app by pressing the [FREEVIEW PLAY] button.
- Access the 7 day TV guide by pressing the [RED] button.

3) Press [EXIT] to exit the 'Catch Up' menu

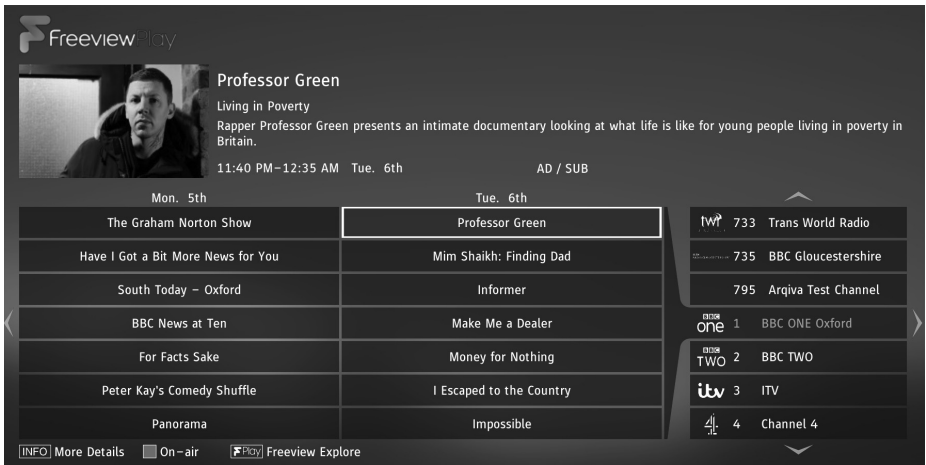

# CHANNEL LIST

To activate the channel list, press the [OK] button on the remote control when on a DTV channel. This allows you to quickly select a channel to watch – select the desired channel by using the up and down arrows or the Channel +/- buttons on the remote control. Press [OK] to watch.

While in this menu the following two options can be selected.

Filter Channels; press [INFO]	This allows you to filter the channels shown in the channel list by type. Select from All, Favorites TV, HD, Data or Radio	
Edit Channels; press [MENU]	Entering this function allows you add channels to your favorite list, skip or delete channels. Use the arrow buttons to select the option.	
	Favorite	Add a channel to your favorite list by pressing [OK] when on the desired channel. Press again to remove from favorite list. Favorites can be selected in normal Digital Television mode by pressing the [FAV] button.
	Skip	When in the Digital Television mode, and using the Channel +/- buttons, the selected channel will be skipped. Select a channel to be skipped by pressing the [OK] button, to deselect press the [OK] button again.
	Delete	Permanently delete channel. Can only be recovered by retuning. To select a channel for deletion, press the [OK] button.
	Lock	Will only appear when lock is enabled in lock menu. Locks the channel that you are on.

**Note:** If channels are moved or deleted, any settings made to record on that channel will not work.

## USB RECORDING (FREEVIEW AND SAORVIEW ONLY)

The USB Record/PVR function is only available in Freeview/Saorview mode and only when used in conjunction with a compatible USB memory stick or USB hard drive. The benefits of this are as follows:

- Pause live TV and then playback, rewind and fast forward (up to live TV).
- One button record, if you decide you want to record the current programme.
- Easy recording from the 7 Day TV Guide.

Due to the nature of the product, it is necessary to use a high-speed USB memory stick (as the TV reads from and writes to the memory stick at the same time, some memory sticks may not be suitable).

You can purchase high speed memory sticks from some computer stores, alternatively, we have a selection of tested and compatible memory sticks available to purchase directly from the Helpline/website.

### Recommended Minimum Specification - USB Memory Stick

Read Speed	20 Mb/s (Megabits Per Second)	If you wish to use a USB portable hard drive larger than 32GB, please refer to the FAQ section at the rear of this user guide.
Write Speed	6 Mb/s (Megabits Per Second)	

### Pause Live TV (Time Shift)

A USB memory stick/hard drive must be connected to the TV in order to use this feature.

- Press the [PLAY/PAUSE] button and the television will pause and the live content will be recorded. To resume watching press [PLAY/PAUSE] again.
- Press [FAST FORWARD] to go forward in a recording.
- Press [FAST REWIND] to go back in a recording.

**Note:** When you switch the TV to standby or change channel the 'Time Shift' memory is wiped. To restart time shift you must press [PLAY/PAUSE] button.

**Note:** If channels are moved or deleted, then the USB Record/PVR will not function correctly.

**Note:** This television contains one TV tuner, therefore it can only record the channel you are watching or record one channel while the television is in standby mode.

**Note:** USB Record/PVR record function is only available in Digital/Freeview TV mode. Due to copyright laws and illegal copying/recording it is not possible to record to/from any other input/output source.

**Note:** Recorded content can only be played back on the device that recorded it. It is not permitted (or possible) to watch content recorded on the TV from Freeview/Saorview on another device.

### One Button Record







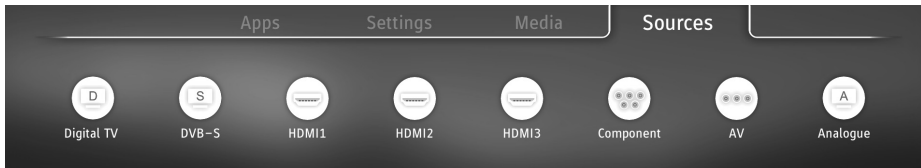

At any point in time you may decide to record the current programme that you are watching. To do this you need to press the red record button on the remote control.



**Note:** Record functions are only applicable to sets with the built in USB Record/PVR function.

# SOURCE MENU



	Digital TV	Select this input to watch Digital Television from your local transmitter. The set must be tuned into watch programmes. Refer to the ' <b>Channel</b> ' menu section of these Operating Instructions for information on how to tune your set into digital channels.
	DVB-S	Satellite tuner input. If a satellite aerial is connected and the set tuned to these channels, select this input to view them.
	HDMI 1	First HDMI input.
	HDMI 2	Second HDMI input.
	HDMI 3	Third HDMI input.
	Component	Y/Pb/Pr input. Audio is connected to the set via the AV input connector.
	SCART	SCART input connectivity.
	AV	Component input. Audio is connected to the set via the AV input connector.
	Analogue	Analogue tuner input.

**Note:** Inputs may vary depending on your television specification.

**Note:** If the inputs have been renamed, they will not appear as shown above.

# CONNECTIONS

**Note:** The TV input/output connections and connecting cables on these pages are shown for reference . Cables are available separately from your retailer. **Not all connections are available on all TV models.**

## Connecting to a device with Composite AV/Video output

TV source should be set to Composite/AV

Connection example TV models with Mini-AV input

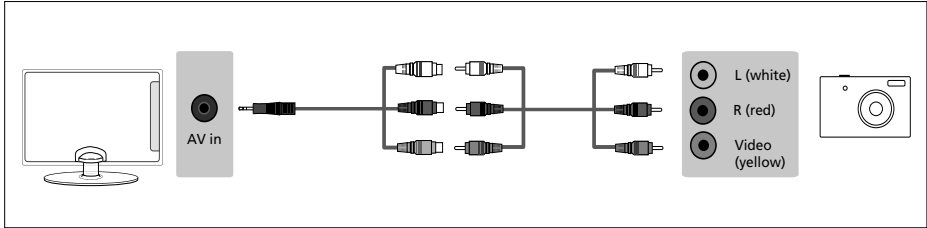

Connection example for TV models with AV input

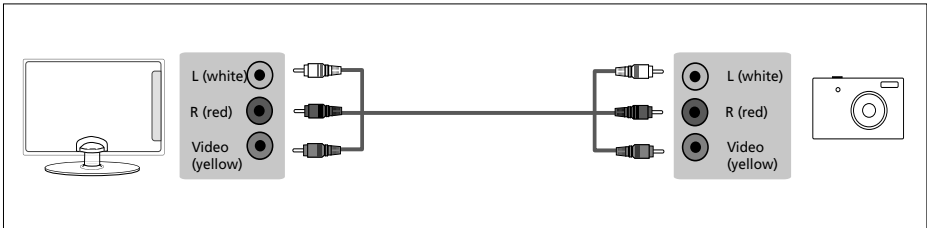

## Connecting to a device with SCART output

TV source should be set to SCART

Connection example for TV models with SCART input

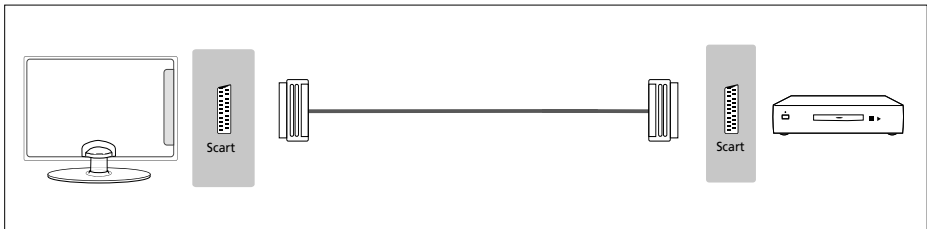

Connection example for TV models with Mini-AV input (1)

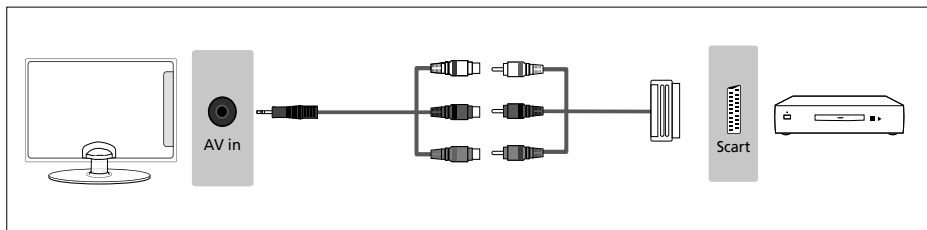

# CONNECTIONS

Connection example for TV models with Mini-AV input (2)

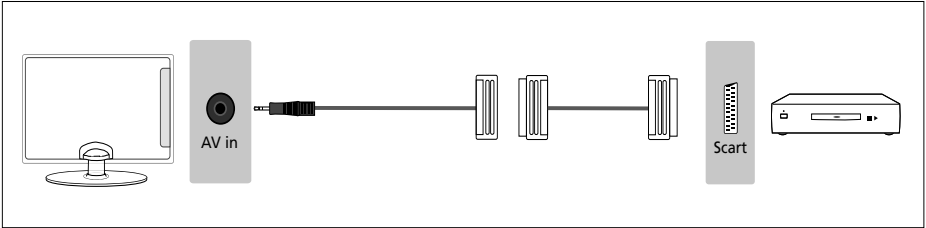

Connection example for TV models with L/R Audio and Video inputs

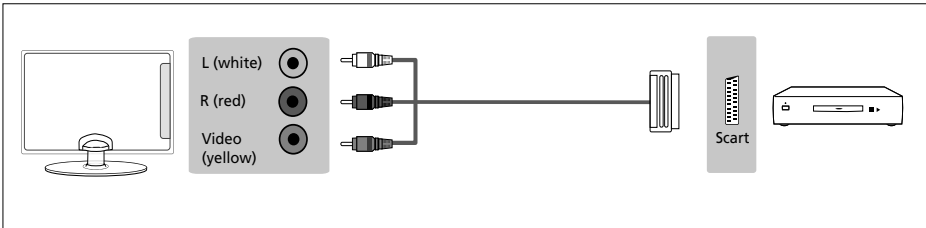

## Connecting to a device with Component/YPbPr output

If you are supplied with a cable from the device which has RED, GREEN, BLUE, RED & WHITE connectors you must connect via Component (for picture) and by Phono cable (for sound). TV source should be set to Component/YPbPr

Connection example for TV models with Mini-YPbPr and Mini-AV inputs

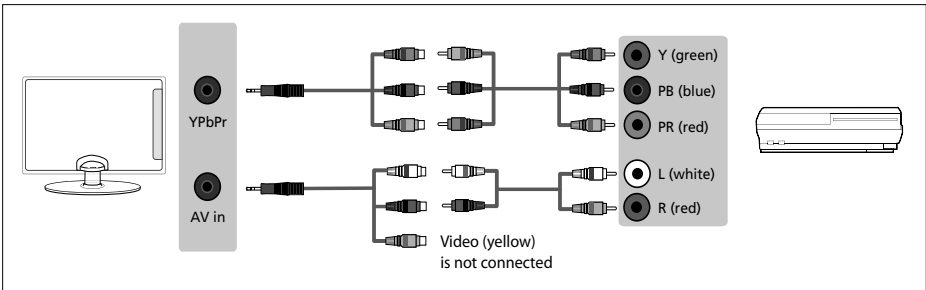

Connection example for TV models with Mini-YPbPr and L/R audio inputs

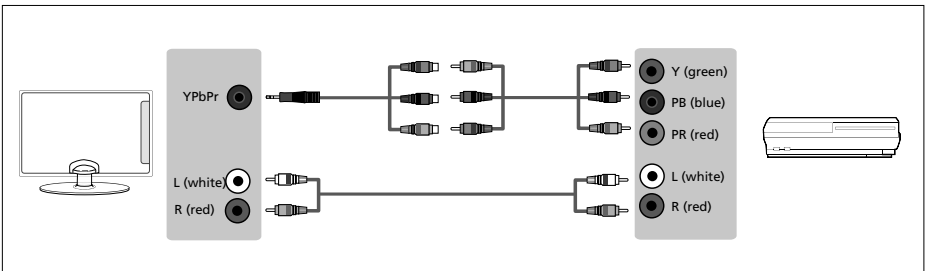



# CONNECTIONS

Connection example for TV models with YPbPr and L/R Audio inputs

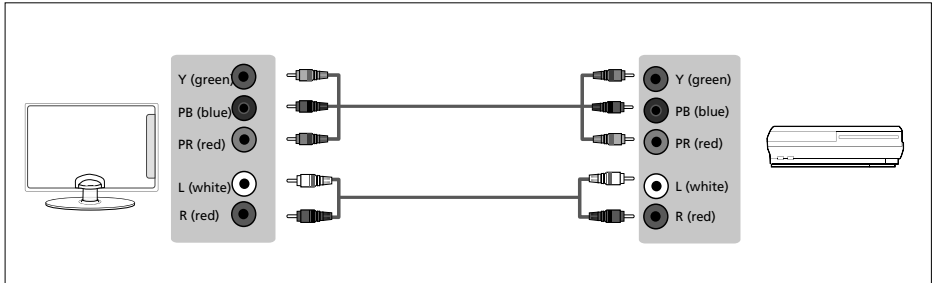

Connection example for TV models with YPbPr and Mini-AV inputs

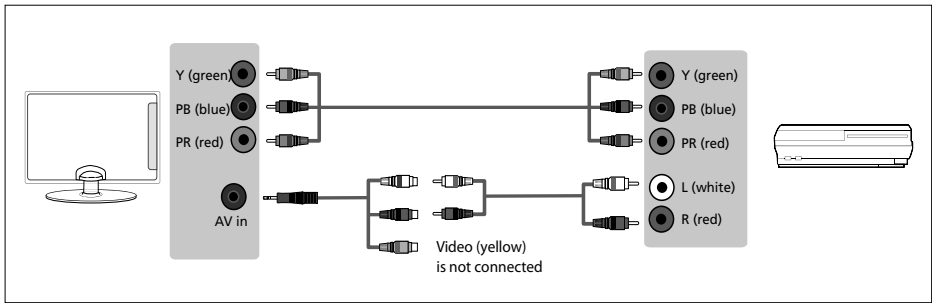

## Connecting to an external audio device (Amplifier, Surround Sound, Sound Bars etc)

When connecting via the TV's 3.5mm earphone output, this will disable the TV speakers.

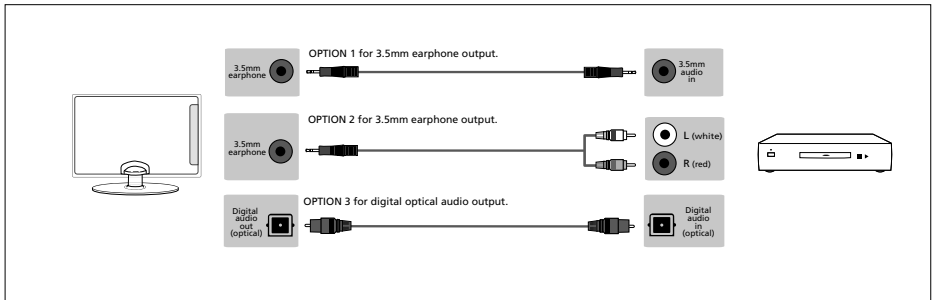

**Note:** When connecting an external audio device to the TV, set the TV volume to a higher than normal level, you will then be able to use your device remote control to adjust the volume of the connected device to suit your requirements.

# CONNECTIONS

## Connecting to a device with HDMI output

A HDMI cable can output both video and audio and enables you to enjoy digital-quality video and audio with minimal loss of quality.

TV source should be set to the corresponding HDMI port (HDMI 1, HDMI 2 etc)



## Connecting to a device with RF output (CCTV or other Analogue devices)

TV source should be set to ATV/Analogue TV.

**Note:** You will need to manually tune your device into an analogue channel.

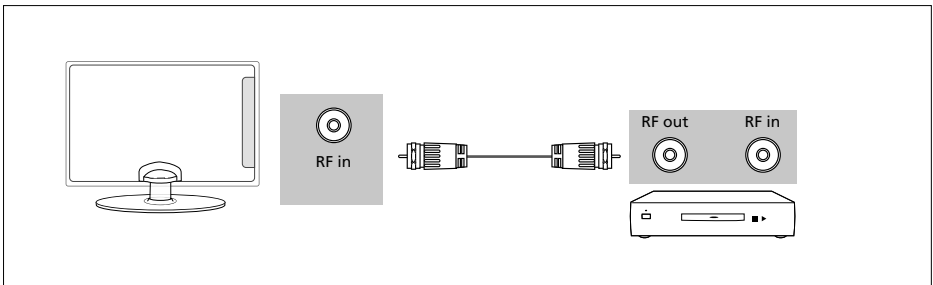

## Connecting an Ethernet/Network cable

The Ethernet port is used only for Pay TV services and Freeview HD (Freeview services are only available in the UK). It is not intended for internet use.

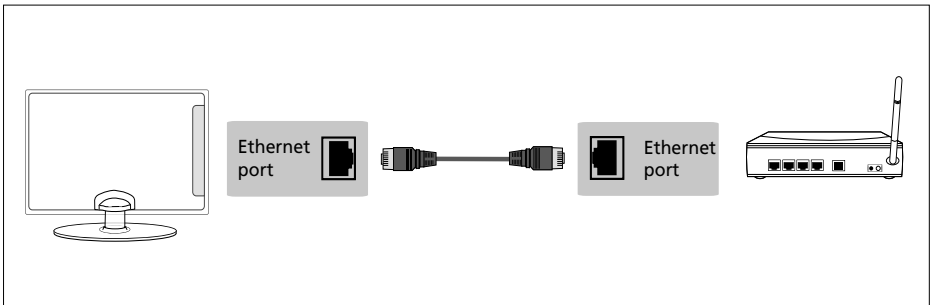

# CONNECTIONS

## Connecting to a USB device

To use the USB input, TV source should be set to USB Media.

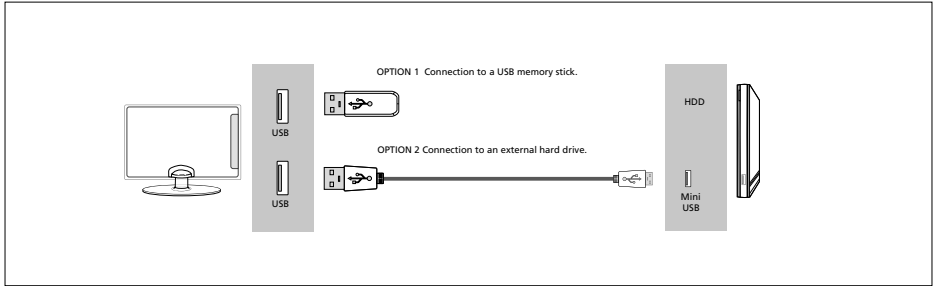

**Note:** Tablets and/or phones can be charged via the USB port, however, it's not possible to play back media from these devices.

**Note:** Some USB devices may need to be connected to an external power supply before being used with this input, i.e. powered hard drive.

## Connecting the TV to Earphones

When connecting via the TV's 3.5mm earphone output, this will disable the TV speakers.

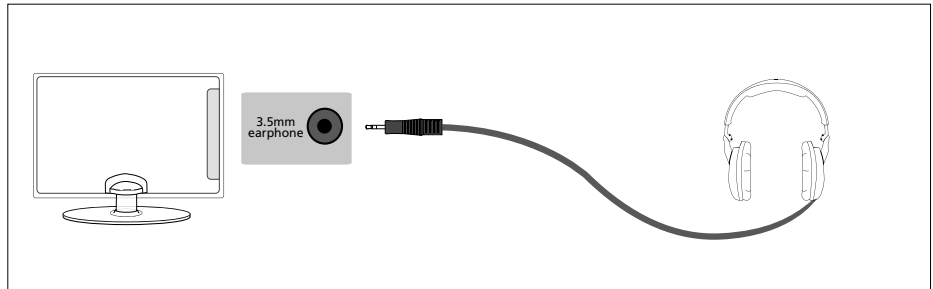

# TROUBLESHOOTING GUIDE

General	I would like to have louder sound by connecting additional speakers or a Soundbar.	<p>1) Use either the 3.5mm headphone output on the TV and a 3.5mm to phono cable (available separately) to connect to an amplifier/surround sound/soundbar. Please note this will deactivate the TV's built in speakers.</p> <p>or:</p> <p>2) Connect a digital optical audio cable from the TV's digital optical audio output to your amplifier/surround sound/soundbar digital optical audio input.</p>
General	Why are some options in the menu unavailable and greyed out.	Some options are only available in certain inputs/sources, i.e. HDMI. They are unavailable in the other sources where they have no effect.
General	Can I stop my TV automatically turning off after 4hrs?	Yes, in the <b>'Time'</b> menu settings, scroll down to Auto Standby and select OFF.
TV	I have tuned in Digital TV but I am not receiving any or all of the channels and/or the channels I receive are breaking up.	<p>1) Check you are in an area that can receive Freeview/Saorview, visit <a href="http://www.freeview.co.uk">www.freeview.co.uk</a> or <a href="http://www.saorview.ie">www.saorview.ie</a></p> <p>2) Check you are using an aerial that is able to receive a good digital signal. In most cases, you will need an outdoor digital hi-gain/wideband aerial. In areas that have excellent digital coverage, you may be able to use a loft type aerial but it is highly likely that you will also need to connect a booster between the back of the TV and the TV aerial wall socket. Unfortunately, to receive a good enough digital signal, it is not possible to use a portable/indoor type aerial.</p>
TV	I have re-tuned my television but when I switch it off it is not storing the channels.	<p>If the TV does not save the channels when you power it off, it's likely the channel database has become corrupt.</p> <p>1) Turn off the TV.</p> <p>2) Remove the RF/Aerial cable from the rear of the TV and then turn the TV back on again.</p> <p>3) Using the remote control, press [MENU] followed by 8-8-8-8 to enter the initial setup/first time installation menu.</p> <p>4) Press OK (let the TV run the full tuning process).</p> <p>5) Once completed, turn off the TV, reconnect the RF/Aerial cable then turn the TV back on again.</p> <p>6) Repeat steps 3 &amp; 4.</p>
VCR/DVD Recorder	I have connected the TV to my VCR or DVD Recorder via SCART but it is not recording.	In addition to connecting via SCART, you should connect the aerial cable from the wall socket to your VCR/DVD Recorder and another aerial cable from the VCR/DVD Recorder to the TV.
Game Consoles	I have connected my Playstation/Xbox to the TV via HDMI, but I am not receiving any pictures or sound on my Television.	<p>1) Ensure the TV's source is set to HDMI.</p> <p>2) Check your settings on your Playstation/Xbox are as per the Playstation/Xbox instruction manual.</p>
Game Consoles	I have connected my Playstation/Xbox to the TV via Component cables (red, green & blue) but I am not receiving any sound.	Component cables only provide HD pictures. For the sound you will need to connect the red & white audio cables on the Playstation/Xbox to the red & white Phono inputs (or mini AV input where fitted) on the rear of the TV. Please refer to the 'Connections' pages.
System Lock	I have changed the password on the television and now forgotten it.	There is a master password of 4711, to gain access to the TV menu and reset the normal password.
USB Mode	I have inserted a USB Memory Key, but the TV does not recognise it.	Ensure the USB Memory Key is formatted to type FAT32.
USB Mode	Using a USB portable hard drive / larger than 32GB.	<p>If you wish to use a portable hard drive larger than 32GB, please note that it must be formatted to the FAT32 file system in order to operate on this TV. Windows XP/Vista computers are only capable of formatting up to 32GB, therefore, you will need a software programme/utility to format larger hard drives.</p> <p>Please refer to the website, <a href="http://www.umc-uk.co.uk">www.umc-uk.co.uk</a>, for more information.</p>

# TROUBLESHOOTING GUIDE

DVD (For TV models with DVD only)	I have inserted a disc but it is not playing.	<ol style="list-style-type: none"> <li>1) Ensure you have inserted the disc facing the correct way.</li> <li>2) Ensure the disc is clean and is not scratched.</li> <li>3) Some copied discs will not play.</li> <li>4) Check the DVD is a region 2 disc – to change the region of the DVD player, refer to <a href="http://www.ums-uk.co.uk">www.ums-uk.co.uk</a>, select 'Changing DVD Region' in the 'Product Support' section</li> </ol>
DVD (For TV models with DVD only)	I have pressed the eject button but the disc is not coming out.	To eject the disc hold the stop/eject button for 4 seconds.
USB Record (For TV models with USB record only)	I cannot change the channel, access the menu or use the red button.	During time shift you cannot change the channel, access the menu or use the red button.
USB Record (For TV models with USB record only)	When using the USB to record the picture 'breaks up' or experience loss of sound.	Check the USB memory stick meets the minimum read speed requirements. Standard definition channels require a read speed of 20 Mb/s (Megabits per second) and a write Speed of 6 Mb/s (Megabits per second) HD channels require the read speed of 80 Mb/s (Megabits per second) and a write speed of 40 Mb/s (Megabits per second). USB 3.0 sticks should be used where possible.
Freeview HD	I cannot access all Freeview channels.	Some data channels for Freeview can only be obtained when the TV's ethernet port is connected to your router.
Freeview HD	I cannot find the Freeview HD channels.	Freeview HD channels found during tuning will be placed in channel positions above 100. For example, 101 (BBC1 HD), 102 (BBC2 HD) etc.

## UPDATING SOFTWARE

There are a number of ways in which the software on your set can be updated. When your set is produced, the software installed will ensure the correct operation of the set, this may need to be updated should improvements be made and this is normally carried out automatically if the set is connected to the internet. For sets which do not have internet connectivity or are not connected to the internet, updates can be made via the USB socket on the back of the set.

**Note:** If your set is outside of guarantee and the installation of the software causes a different issue you may be liable for a chargeable repair service. The reason for this is because you may have an inherent fault which can cause corruption on one of the boards when installing the software. This could result in your unit locking into SAFE mode whereby it is stuck in standby. This is not a fault with the software, this would be caused by an existing faulty board that would have required a repair.

If you experience issues installing your software, and you do get locked into safe mode, you may wish to try reinstalling the software on an alternate USB as sometimes if the TV cannot read the update due to the USB Format/type.

**Note:** For further support with software updates, contact our technical support team or refer to the 'Product Support' section of the website. If the TV is using the newest software available it will not attempt to update the software.

OTA	Over the internet update. You will be notified when an OTA update is available for your set. When the software is downloading and then updating, do not power down the set. This will interrupt the process and may corrupt the set.
USB	Software can be uploaded onto your set via a USB stick. Only use software recommended by the manufacturer for this.
OAD	Over Air Download. Similar to OTA, but data is sent to the set via the Digital Television system.

## Specifications - USB & DNLA Media Types

Media	Codec	Resolution	Bit Rate	File Extension
Film	MPEG1/2	1080P@60fps	80Mbps	.DAT, .VOB, .MPG, .MPEG, .ts, .trp, .tp, .mp4, .mov, .3gpp, .3gp, .avi, .mkv, .asf
	MPEG4	1080P@60fps	40Mbps	.MPG, .MPEG, .mp4, .mov, .3gpp, .3gp, .avi
	XviD	1080P@60fps	40Mbps	.divx, .mp4, .mov, .avi, .mkv, .asf
	H.263	1080P@60fps	40Mbps	.mp4, .mov, .3gpp, .3gp, .av, .mkv
	H.264	4096x2160@30fps 1080P@60fps	135Mbps	.flv, .mp4, .mov, .3gpp, .3gp, .ts, .trp, .tp, .asf, .wmv, .avi, .mkv
	Motion JPEG	1080P@30fps	10Mbps	.avi, .3gpp, .3gp, .mp4, .mov, .mkv, .asf
	VP8	1080P@60fps	20Mbps	.mkv, .webm
	HEVC	4K2K@60fps	100Mbps	.mp4, .mov, .mkv, .ts, .trp, .tp
	VP9	4K2K@60fps	100Mbps	.mkv, .webm
Media	Codec	Frequency	Bit Rate	File Extension
Music	MPEG1/2 Layer1, 2, 3	16KHz ~ 48KHz	32Kbps ~ 320Kbps	.mp3, .avi, .as, .mkv, .ts, .trp, .tp, .DAT, .VOB, .MPG, .MPEG, .wav
	AC3	32KHz, 44.1KHz, 48KHz	32Kbps ~ 640Kbps	.ac3, .avi, .mkv, .divx, .3gpp, .3gp, .mp4, .mov, m4a, .ts, .trp, .tp, .DAT, .VOB, .MPG, .MPEG, .rm, .rmvb
	EAC3	32KHz, 44.1KHz, 48KHz	32Kbps ~ 6Mbps	.ec3, .3gpp, .3gp, .mp4, .mov, m4a, .ts, .trp, .tp, .DAT, .VOB, .MPG, .MPEG
	AAC, HEAAC	8KHz ~ 48KHz	128bps ~ 320Kbps	.aac, .avi, .mkv, .divx, .3gpp, .3gp, .mp4, .mov, m4a, .ts, .trp, .tp, .DAT, .VOB, .MPG, .MPEG, .v, .rm, .rmvb
	VORBIS	Up to 48KHz		.mkv, .webm, .3gpp, .3gp, .mp4, .mov, m4a, .ogg
	DTS	Up to 48KHz	< 1.5Mbps	.ts, .trp, .tp, .DAT, .VOB, .MPG, .MPEG, .mkv
	FLAC	8KHz-96 KHz	< 1.6Mbps	.mkv, .ac
Media	File Type	Resolution		File Extension
Photo	JPEG	15360x8640, (1920x8 x 1080x8)	Base-line	.jpg/.jpeg
		1024x768	Progressive	
	PNG	9600x6400	Non-interlace	.png
		1200x800	Interlace	
	BMP	9600x6400		.bmp
	MPO	15360x8640, (1920x8 x 1080x8)	Base-line	.mpo
1024x768		Progressive		
GIF	6400x4800		.gif	

## Quick Lookup: Specifications - USB & DNLA Media Types

	File Extension	Container	Subtitle Codec
Internal Subtitle	.mp4	MP4	DVD Subtitle, UTF-8 Plain Text
	.mkv	MKV	ASS, SSA, UTF-8 Plain Text, VobSub, DVD Subtitle
	.avi	AVI(1.0, 2.0)	XSUB, XSUB+

	File Extension	Subtitle Parser	Remark
External Subtitle	.srt	SubRip	
	.ssa/ .ass	SubStation Alpha	
	.smi	SAMI	
	.sub	SubViewer, Micro DVD, DVD Subtitle System, Subldx (VobSub)	SubViewer 1.0 & 2.0 Only
	.txt	TMPlayer	



# QUICK LOOKUP

**Application Menu** (Only applicable to Freeview Play models.)

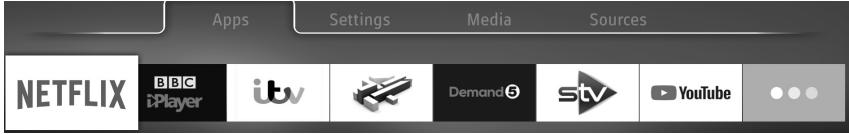

Netflix	UK Play TV	Web Browser
BBC iPlayer	Freeview Play	Aquos Net+
ITV Player	YouTube	
Channel 4/All 4	BBC News	
Demand 5	BBC Sport	

**NOTE:** For sets without Freeview Play, there will be no on-demand or Freeview Play apps.

## Settings Menu

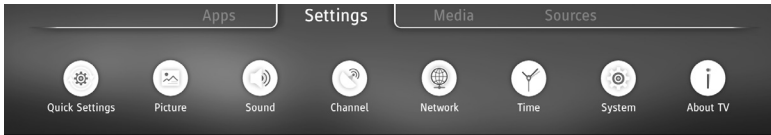

Menu	Contents	Page
Quick Settings	<ul style="list-style-type: none"> <li>Audio Track</li> <li>Subtitle</li> <li>Subtitle Track</li> <li>Teletext</li> <li>Record List</li> <li>Schedule List</li> </ul>	18
Picture	<ul style="list-style-type: none"> <li>Picture Mode</li> <li>Brightness</li> <li>Contrast</li> <li>Colour</li> <li>Sharpness</li> <li>Colour Temperature</li> <li>Aspect Ratio</li> <li>Expert Settings</li> </ul>	19-20
Sound	<ul style="list-style-type: none"> <li>Sound Mode</li> <li>DTS Studio Sound</li> <li>DTS DRC</li> <li>Speaker</li> <li>Auto Volume Level</li> <li>Expert Settings</li> </ul>	21

Continued on next page.

# QUICK LOOKUP

Menu	Contents	Page
Channel	<ul style="list-style-type: none"> <li>DVB Antenna</li> <li>Auto Scan</li> <li>Digital Manual Tuning</li> <li>Digital Smart Retuning</li> <li>Auto Update Channel List</li> <li>HbbTV</li> <li>LCN</li> <li>Standby Scan</li> <li>CI Information</li> </ul>	22
Network	<ul style="list-style-type: none"> <li>Network</li> <li>Network Test</li> <li>Network Information</li> <li>Wi-Fi</li> <li>IPv4</li> <li>IPv6</li> </ul>	24-25
Time	<ul style="list-style-type: none"> <li>Time</li> <li>On Time</li> <li>Off Time</li> <li>Sleep Timer</li> <li>Auto Standby</li> <li>OSD Timer</li> </ul>	26
System	<ul style="list-style-type: none"> <li>Language</li> <li>Lock</li> <li>HDMI CEC</li> <li>Source Re-name</li> <li>Expert Settings</li> </ul>	27
About TV	<ul style="list-style-type: none"> <li>Help Information</li> <li>System Upgrade</li> <li>Reset TV</li> <li>Netflix ESN Key</li> <li>Netflix ESN Version</li> <li>Netflix Deactivate</li> <li>Netflix Terminate</li> <li>View End User Licence</li> </ul>	28





SHA/MAV/0395



UMC Poland sp. z o.o

Ostaszewo 57B, 87-148 Lysomice,  
Poland

Assembled in Poland

[www.sharp.eu/av](http://www.sharp.eu/av)

**SHARP**