

# Anson - Deluxe Executive Desk

## ANS-DED



### ASSEMBLY INSTRUCTIONS

Anson  
Rectangular Desk

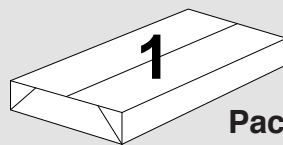

Pack 1:  
Top Pack

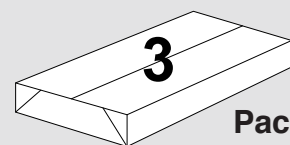

Pack 3:  
Corner Kit

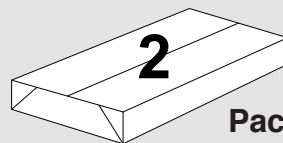

Pack 2:  
Rail Kit

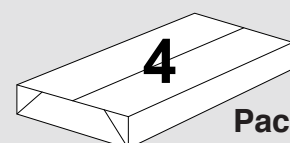

Pack 4:  
1000 Leg  
Kit

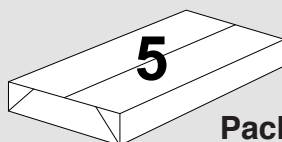

Pack 5:  
600 Leg Kit

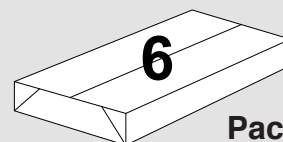

Pack 6:  
Modesty Kit

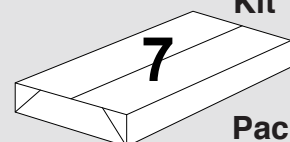

Pack 7:  
Modesty  
Pack

TOOLS REQUIRED  
FOR ASSEMBLY

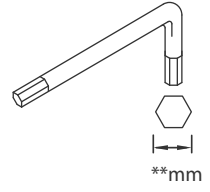

DONT STRUGGLE  
2 MAN LIFT

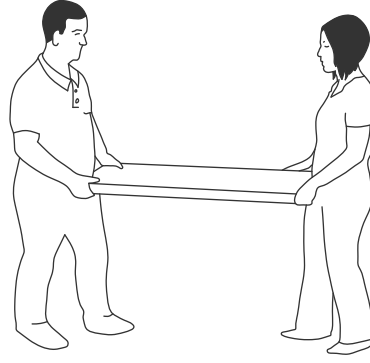
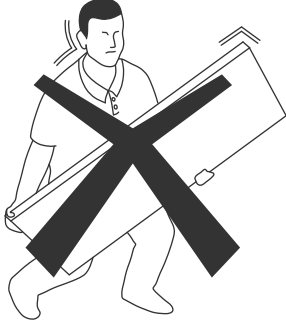

ALWAYS HANDLE  
ITEMS WITH CARE

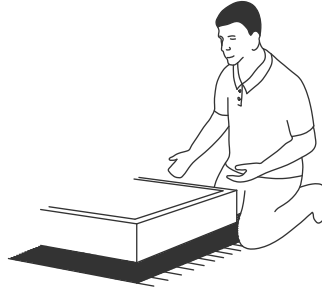
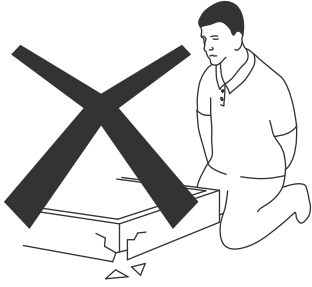

IF UNSURE CALL  
FOR ASSISTANCE

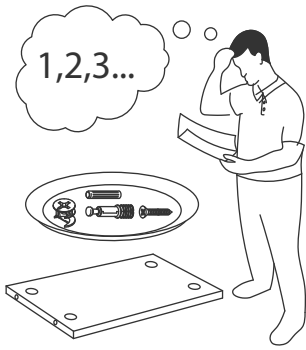

KEEP FITTINGS AWAY  
FROM CHILDREN

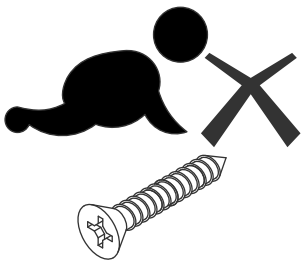



Please check that you have all the panels

**ANS-EXEC-TOP**

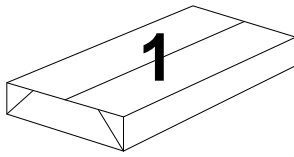

**PACK 1:**  
1 x Top Panel

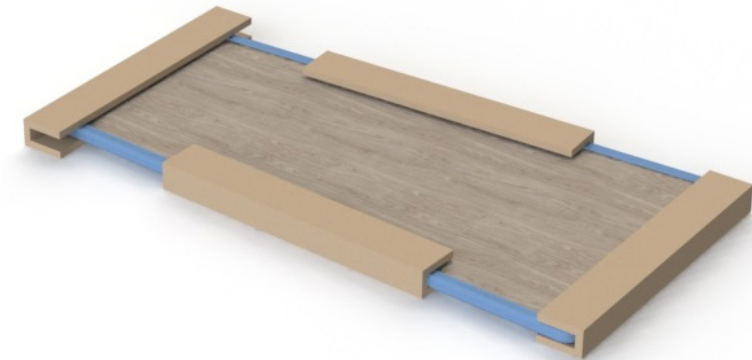

**HN-RAIL-2200**

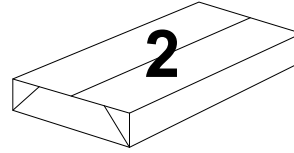

**PACK 2:**  
1 x Rail Kit



**HN-CAST**

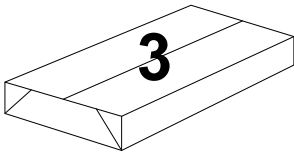

**PACK 3:**  
1 x Corner Kit



**HN-LEG10-KIT**

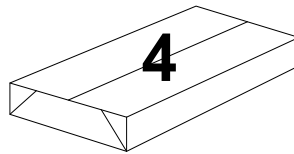

**PACK 4:**  
1 x 1000 Leg Kit



**HN-LEG6-KIT**

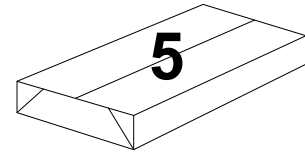

**PACK 5:**  
1 x 600 Leg Kit



**HN-MBKT-KIT**

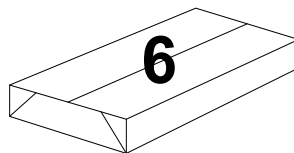

**PACK 6:**  
1 x Modesty Kit

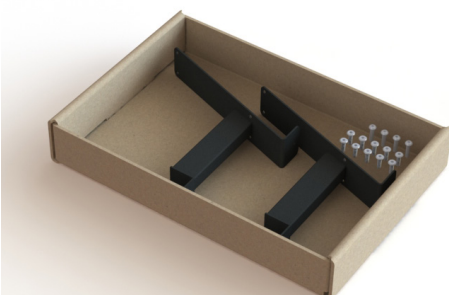

**ANS-EXEC-DMOD**

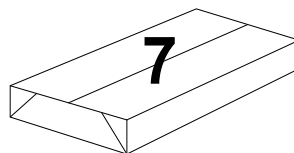

**PACK 7:**  
1 x Modesty Panel

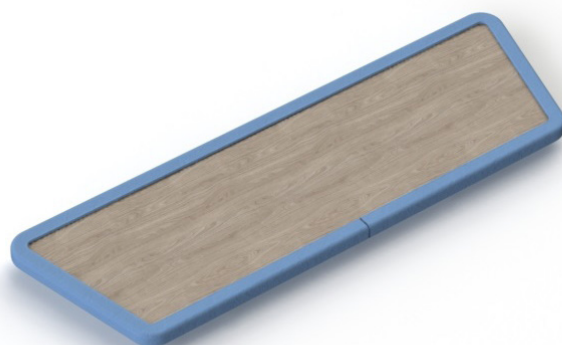



Please check that you have all the fittings

### FITTINGS SUPPLIED



M6 Connector Bolt

Size  
25mm

PCS  
58

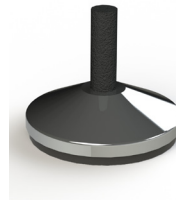

Adjustable Foot

Size  
25mm dia.

PCS  
4

1

## ANSON DELUXE DESK ASSEMBLY

### Step 1

Unpack your Anson rectangular desk and please recycle all packaging.

Place the top face down so that the fixing holes are face-up.

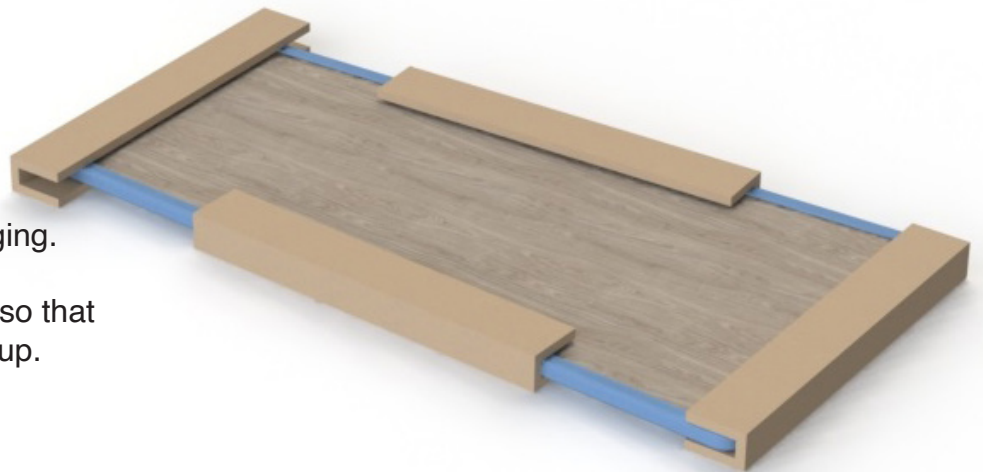

2

image 'a'.

image 'b'.

### Step 2

Assemble the legs as per 'image a' using parts from both leg kit & corner kit.

Link all the legs together attaching them to the side rail as per 'image b'

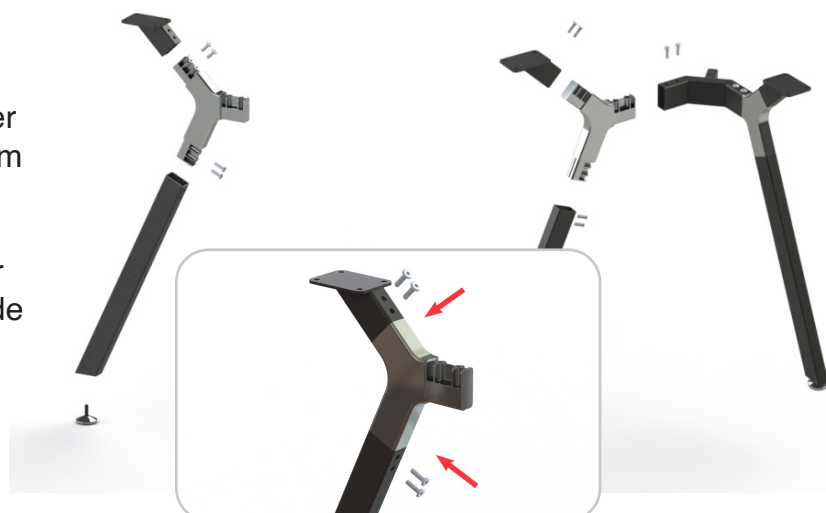

# ANSON DELUXE DESK ASSEMBLY

## 3

### Step 3

Link both the end legs together attaching them with the rail kit as per image

Ensure all fixing bolts are tightened turning in a clockwise position.



## 4

### Step 4

Once the frame is assembled place on the underside of the top and affix using the 16x M6 bolts as shown.

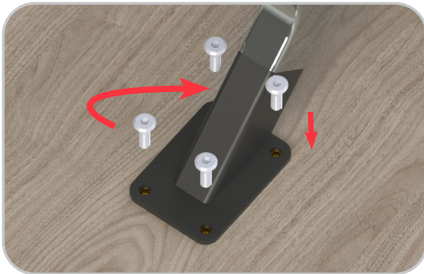

## 5

### Step 5

Attach the modesty panel fixing brackets by hooking onto the cross rail and affix using the 4x M6 bolts as shown.

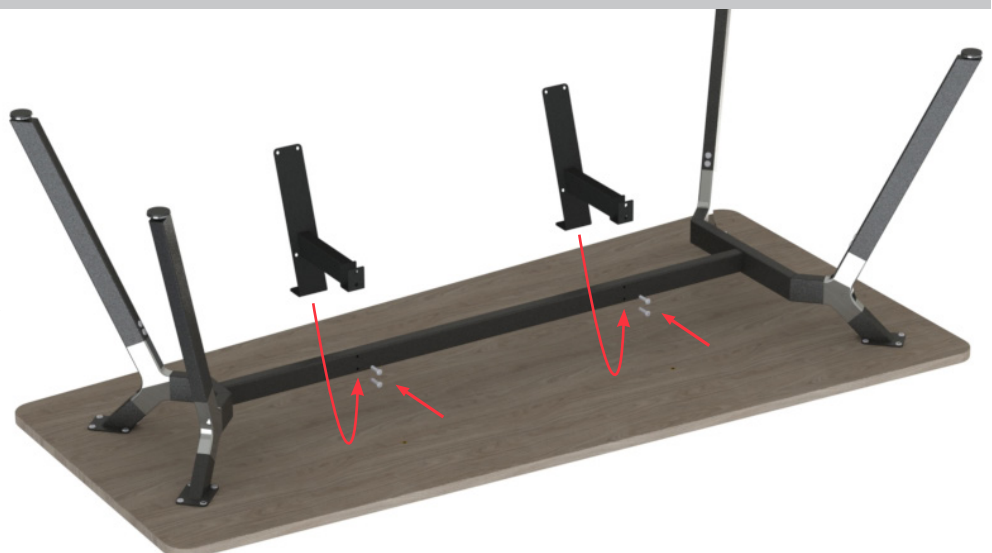

# ANSON DELUXE DESK ASSEMBLY

## 6

### Step 6

Fix the modesty brackets to the underside of the top and affix using the 2x M6 bolts.

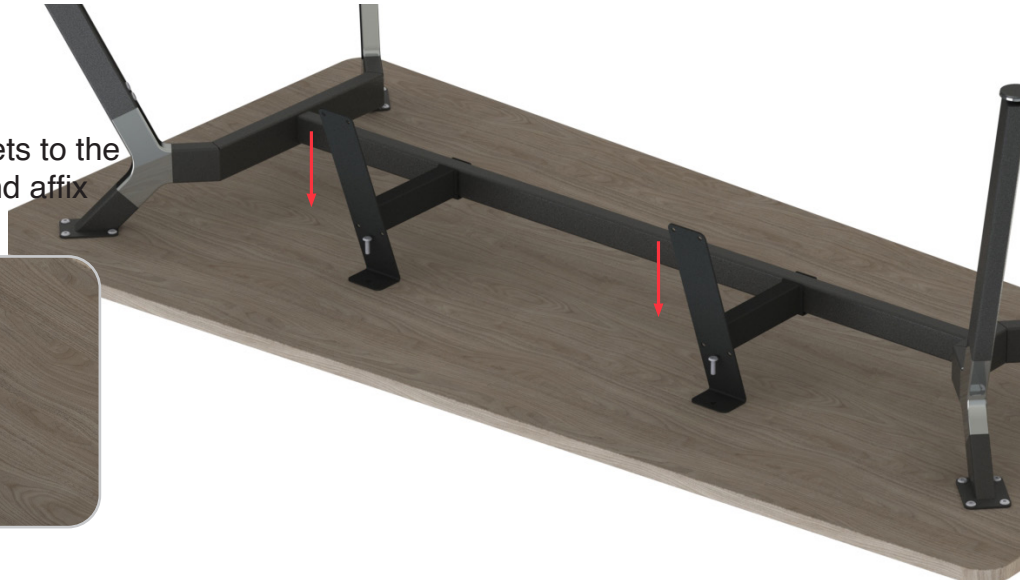
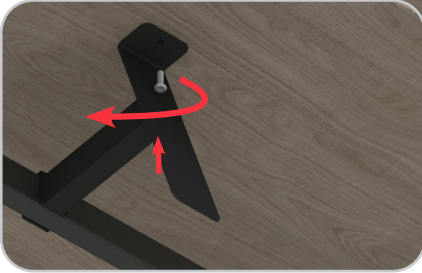

## 7

### Step 7

Align the modesty panel to the modesty panel brackets and affix using the 8x M6 bolts as shown.



## 8

### Step 8

Once complete ensure all fixings bolts are tightened, and with 2x person(s) lift and turnover the desk into it's upright position.

